

# Temperature Measurement and Control Catalog

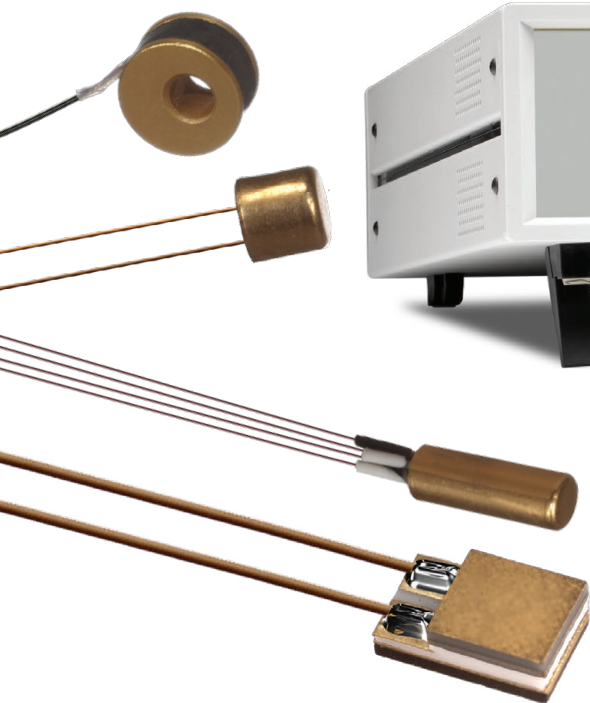

## Welcome



For over 50 years, Lake Shore Cryotronics has provided reliable and robust temperature measurement and control products for customers like you. Supporting your low-temperature research has been our primary pursuit since the beginning.

In these pages, you'll see a number of solutions for measurement, control, and monitoring. Featured products include industry-leading Cernox® and silicon diode sensors, ultra-low-temperature controllers, and an AC resistance bridge. But you'll also see a number of new products. These additions are reflective of our commitment to continuous innovation in cryogenic product development.

In addition to product selection guides, the catalog includes a wealth of technical information, including technical data, performance characteristics, and a comprehensive reference section. The Appendices are where you can learn more about thermometry, sensor characteristics, and tips for proper sensor installation, as well as common units and conversions charts, cryogenic reference tables, and other useful information.

If you cannot find the information that you need, please contact Lake Shore. Our global sales and service representatives are ready to answer your questions and to help you find the right solution for your application.

Thank you for your support and feedback as we continue to innovate and create products that advance your pursuit of science.



Michael S. Swartz  
President and CEO

Copyright © Lake Shore Cryotronics, Inc. All rights reserved. Specifications are subject to change.

Lake Shore Cryotronics, the Lake Shore logo, the square graph logomark, Cernox, and QMSA are registered trademarks of Lake Shore Cryotronics, Inc. CalCurve, SoftCal, Duo-Twist, Quad-Twist, Quad-Lead, and Rox are all trademarks of Lake Shore Cryotronics, Inc. All other trade names referenced are the service marks, trademarks, or registered trademarks of their respective companies.

American Express and the American Express Box Logo are registered trademarks of American Express Company; Apiezon is a registered trademark of M & I Materials, Ltd.; CryoCable is a trademark of Omega Engineering, Inc.; Dacron, Kapton, Mylar, Teflon, and Vespel are registered trademarks of E. I. Du Pont de Nemours & Co.; Evanohm is a registered trademark of Carpenter Technology Corp.; Fair-Rite is a registered trademark of Fair-Rite Products Corp.; Gel-Pak is a registered trademark of GEL-PAK, LLC; Kester is a registered trademark of Litton Systems, Inc.; Kynar is a registered trademark of Atochem North America, Inc.; LabVIEW is a trademark of National Instruments Corporation; Lemo is a registered trademark of Lemo USA, Inc.; MasterCard and the Distinctive Interlocking Circles Design are registered trademarks of MasterCard International Incorporated; Ostalloy is a registered trademark of Umicore; Pyrex is a registered trademark of Corning Incorporated; Scotch is a registered trademark of 3M Company; Stay-Silv is a registered trademark of J.W. Harris Co., Inc.; Stycast is a registered trademark of Emerson & Cuming; Swagelok is a registered trademark of Swagelok Company; UL is a registered trademark of Underwriters Laboratories Inc.; Visa and the Visa Comet Design Mark are registered trademarks of Visa.

All other trademarks or service marks noted herein are either property of Lake Shore Cryotronics, Inc., or their respective companies.



## Contents



Introduction ..... 5



Sensors ..... 9



Instruments ..... 59



Accessories ..... 135



Appendices ..... 155



Customer Service ..... 217

# Lake Shore Cryotronics, Inc.

## Company Overview

### Over 50 years of cryogenic excellence

Leading researchers around the world trust Lake Shore for advanced solutions that drive the discovery and development of new materials for tomorrow's technologies. In electronics, clean energy, nanotechnology, and many other applications, Lake Shore provides the products and systems needed for precise measurements over a broad range of temperature and magnetic field conditions.

Serving the needs of the research community since 1968, Lake Shore has grown its product solutions to keep pace with evolving interests in scientific exploration, from the physics lab to deep space.

Lake Shore provides solutions to an international base of research customers at leading university, government, aerospace, and commercial research institutions and is supported by a global network of sales and service facilities.

Through our global technical service and sales teams, we foster a culture of collaboration and innovation, and a commitment to the pursuit of science. When you work with Lake Shore, you're dealing with a company that is run by scientists and engineers for the purpose of advancing the work of scientists in many research fields.

This ongoing interaction with the global research community spurs continual innovation of our product offering, advancements that will, in turn, enable researchers to explore new phenomena for new insight into cryogenic measurement.



## Our Mission

### **Lake Shore is committed to our customers' advancement of science and technology to benefit humanity**

We want to advance science by providing easy to use, high value and high performance products.

We support an international base of scientists and researchers as they explore and develop tomorrow's technologies. To us, "Advancing Science" is more than just a tagline. Helping customers around the world in their pursuit of science is the driving force behind our ongoing product research and development.

Lake Shore stands behind its customers, with exceptional, technically knowledgeable customer service and a three-year warranty on every product we sell.

Lake Shore is ISO 9001:2008 certified, a sign of our commitment to continuous improvement.









# Sensors

- 10 Sensor Selection Guide
- 14 Sensor Characteristics
- 20 Sensor Packages and Mounting Adapters
- 27 Temperature Probes
- 32 Cernox<sup>®</sup> RTDs
- 36 DT-670 Silicon Diodes
- 41 Germanium RTDs
- 44 Ultra-low Temperature Rox<sup>™</sup> RTDs
- 44 Interchangeable Rox<sup>™</sup> RTDs
- 51 PT-100 Series Platinum RTDs
- 54 Capacitance Temperature Sensors
- 56 Thermocouple Wire

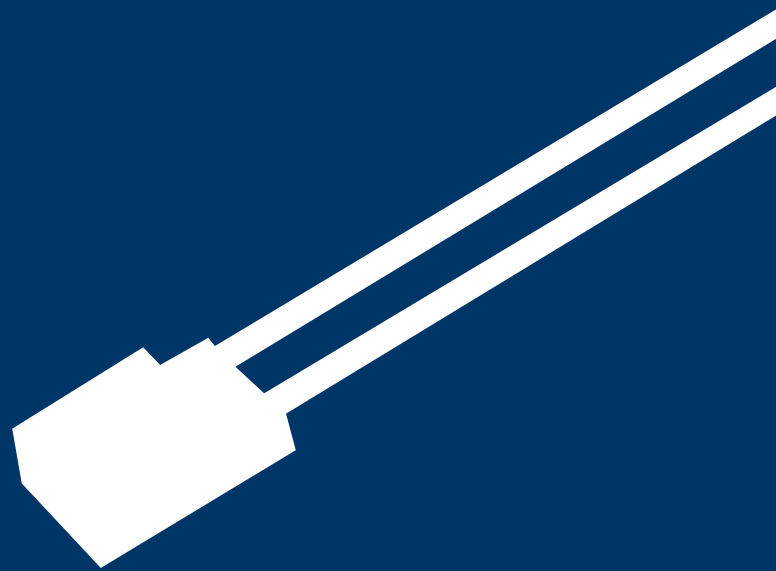



## Sensor Selection Guide

### How to select a temperature sensor for your application

Lake Shore offers the most comprehensive line of cryogenic temperature sensors in the world. We understand that selecting a sensor is a difficult procedure. This catalog will assist you in selecting the most appropriate sensor for your application. The table on the next page is designed to compare the sensor characteristics more easily.

You will find that our sales staff will ask you many questions regarding your application. We ask a lot of questions to inform, educate, and to assist you in selecting the correct sensor. We are here to answer your questions and concerns. If you have any specific needs, please let us know.

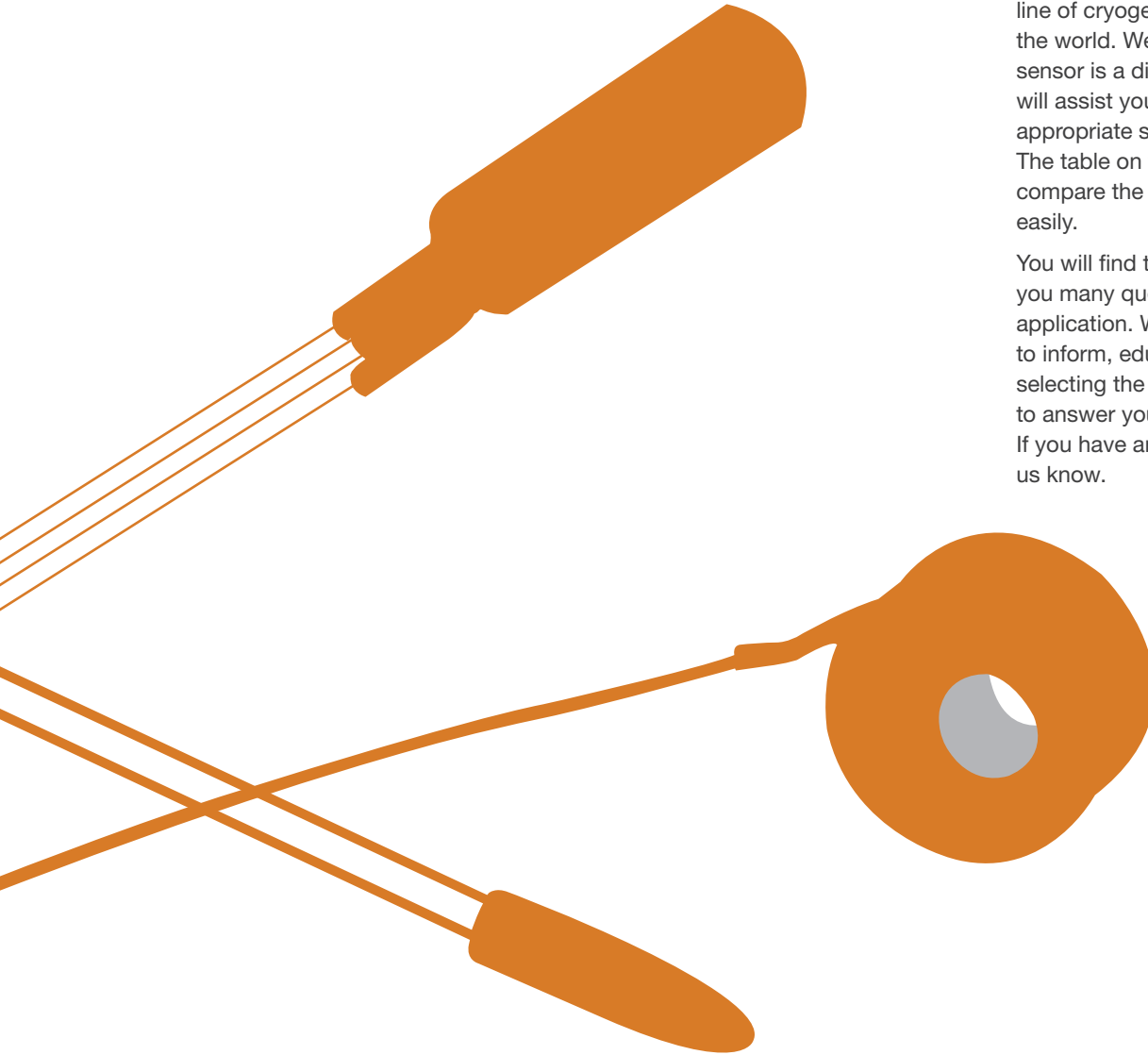



Any one or several of the following environmental factors may be important to you in selecting a sensor:

- Temperature range
- Package size
- Fast thermal response time
- Fast electrical response time
- Heat sinking
- Small thermal mass
- Robustness
- Compatibility with harsh environments
  - Magnetic fields
  - Ionizing radiation
  - Ultra high vacuum (UHV)
  - Vibration/mechanical shock
  - Thermal shock
  - Temperatures above 323 K
- Easily measured signal
- Compatibility with sources of error
  - Thermal EMFs
  - Self-heating
  - Noise pickup
- High sensitivity
- High accuracy<sup>†</sup>
- High repeatability—long and short term
- Low power dissipation
- Interchangeability
- Ease of use
- Low cost
- Available accessories
- Available instrumentation

#### Sensor overview

	Temperature range	Standard curve	Below 1 K	Can be used in radiation	Performance in magnetic field
Diodes					
Silicon	1.4 K to 500 K	×			Fair above 60 K
Positive temperature coefficient RTDs					
Platinum	14 K to 873 K	×		×	Fair above 30 K
Negative temperature coefficient RTDs					
Cernox <sup>®</sup>	0.10 K to 420 K		×	×	Excellent above 1 K
Germanium	0.05 K to 100 K		×	×	Not recommended
Rox <sup>™*</sup>	0.01 K to 40 K	×	×	×	Good below 1 K
Other					
Thermocouples	1.2 K to 1543 K	×			Fair
Capacitance	1.4 K to 290 K				Excellent

\*RX-102B not recommended for use in magnetic fields

Unfortunately, you can't have it all in one sensor. The most stable and accurate temperature sensors are very large, have slow response times and are extremely fragile. The sensors with the highest sensitivity and resolution have the smallest range. Choosing the appropriate sensor for a particular application necessitates prioritizing the requirements for that application.

The sensors described in this catalog are manufactured for the rigors of cryogenic environments, and are designed with specific applications in mind. For much of its history, Lake Shore has focused on cryogenic sensors used for the precise measurement of temperatures from near absolute zero to well above room temperature.

As you continue through the Sensor section of the catalog, you will notice that information is presented in both graphical format as well as in more detailed specifications, pertaining to topics such as the sensor's highlights, typical magnetic field-dependent data, resistance, and sensitivity values.

Characteristics such as packaging are incorporated into each sensor's design with the customer in mind. To learn more about what package would be best for your application, please refer to the Sensor Packages and Mounting Adapters section. For more detailed information, see Appendix C.

<sup>†</sup> The use of the terms accuracy and uncertainty throughout this catalog are used in the more general and conventional sense as opposed to following the strict metrological definitions. For more information, see Appendix B: Accuracy versus Uncertainty.



# Sensor Types

## Cernox®

Cernox® sensors can be used from 100 mK to 420 K with good sensitivity over the whole range. They have a low magnetoresistance, and are the best choice for applications with magnetic fields up to 30 T (for temperatures greater than 2 K). Cernox® are resistant to ionizing radiation, and are available in robust mounting packages and probes. Because of their versatility, they are used in a wide variety of cryogenic applications, such as particle accelerators, space satellites, MRI systems, cryogenic systems, and research science.

## Silicon diodes

Silicon diodes are the best choice for general-purpose cryogenic use. The sensors are interchangeable (they follow a standard curve) and are available in robust mounting packages and probes. Silicon diodes are easy and inexpensive to instrument, and are used in a wide variety of cryogenic applications, such as cryo-coolers, laboratory cryogenics, cryo-gas production, and space satellites.

## Germanium

Germanium RTDs have the highest accuracy, reproducibility, and sensitivity from 0.05 K to 100 K. They are resistant to ionizing radiation, but are not recommended for use in magnetic fields. Germanium RTDs are used mostly in research settings when the best accuracy and sensitivity are required. Germanium and Ruthenium oxide are the only two sensors that can be used below 100 mK.

## Ultra low temperature Rox™

ULT ruthenium oxide RTDs can be used to below 10 mK. Along with germanium, they are the only sensors that can be used below 100 mK. Calibrations for these sensors are available down to 10 mK, and can include additional extrapolated points to 5 mK. Optical shielding of the RS package reduces unwanted sensor heating, making this sensor ideal for temperature monitoring or controlling below 50 mK.

## Interchangeable Rox™

These interchangeable ruthenium oxide temperature sensors are thick-film resistors. Each interchangeable Rox™ model adheres to a single resistance versus temperature curve. They are often used for applications that require a standard curve in magnetic fields, such as MRI systems. Their upper temperature range is limited to 40 K, and Cernox® are better in magnetic fields above 2 K.

## Platinum

Platinum RTDs are an industry standard. They follow an industry standard curve from 73 K to 873 K with good sensitivity over the whole range. Platinum RTDs can also be used down to 14 K. Because of their high reproducibility, they are used in many precision metrology applications. Platinum RTDs have limited packaging options, but they are inexpensive and require simple instrumentation. They are widely used in cryogenic applications at liquid nitrogen temperatures or greater.

## Capacitance

Capacitance sensors are ideally suited for use as temperature control sensors in strong magnetic fields because they exhibit virtually no magnetic field dependence. Small variations in the capacitance/temperature curves occur upon thermal cycling. It is recommended that temperature in zero field be measured with another temperature sensor, and that the capacitance sensor be employed as a control element only.

## Thermocouples

Thermocouples can be used over an extremely wide range and in harsh environmental conditions, and follow a standard response curve. Less accurate than other sensors, special techniques must be employed when using thermocouples to approach temperature accuracies of 1% of temperature. Thermocouples are used for their small size, extremely wide temperature range (exceeding high temperature limits of platinum RTDs), and simple temperature measurement methodology.



## Lake Shore calibrations

Lake Shore offers complete calibration services from 50 mK to 800 K. Above 0.65 K, Lake Shore calibrations are based on the International Temperature Scale of 1990 (ITS-90). For temperature below 0.65 K, calibrations are based on the Provisional Low Temperature Scale of 2000 (PLT-2000).

Each scale is maintained on a set of germanium, rhodium-iron, and/or platinum resistance secondary thermometers standards. These secondary standards are calibrated at various national labs: NIST, PTB, and NPL. Working thermometers are calibrated against, and routinely intercompared with these secondary standards. For PLTS-2000 calibrations, working sensors are also compared to a superconducting fixed-point set and nuclear orientation thermometer.

Lake Shore offers sensor calibrations down to 10 mK. Our enhanced ultra-low temperature calibration facility includes dilution refrigerators, a nuclear orientation thermometer, and a superconducting fixed point set.

All calibration reports include:

- Certificate of calibration
- Calibration test data and data plot
- Polynomial fit equations and fit comparisons
- Interpolation tables
- Instrument breakpoint tables and data files

### Lake Shore offers three classifications of calibration:

Good	Uncalibrated	Silicon diodes follow standard curve
		Platinum resistors follow standard curve
		Interchangeable Rox™ follow standard curve
		Cernox®, germanium, and ULT Rox™ sensors can be purchased uncalibrated but must be calibrated by the customer
Better	SoftCal™	An abbreviated calibration (2-point: 77 K and 305 K; or 3-point: 77 K, 305 K, and 480 K) that is available for platinum sensors
Best	Calibration	<p>All sensors can be calibrated in various pre-defined temperature ranges for each sensor type. The digits represent the lower range in kelvin, and the letter corresponds to high temperature limit, where:</p> <p>A = 6 K    B = 40 K    D = 100 K    L = 325 K    M = 420 K    H = 500 K    J = 800 K</p> <p>For example: The calibration range “1.4L” would result in a sensor characterized from 1.4 K to 325 K.</p>

# Sensor Characteristics

## Sensor packages and characteristics

	Sensor type/ packages	Temperature range		Physical size <sup>1</sup>	Mass	Typical dimensionless sensitivity S <sub>b</sub>					
		low	high			1.4 K	4.2 K	20 K	77.4 K	295 K	475 K
Silicon diodes	DT-670-SD	1.4 K	500 K	1.08 mm high × 1.905 mm wide × 3.175 mm long	37 mg	-0.01	-0.08	-0.26	-0.13	-1.19	-7.5
	DT-670E-BR	30 K	500 K	0.178 mm × 0.432 mm × 0.406 mm	72.7 µg	-0.01	-0.08	-0.26	-0.13	-1.19	—
Cernox <sup>®</sup>	CX-1010-BC	0.1 K	325 K	3.175 mm × 8.89 mm × 7.620 mm	3.0 mg	-0.68	-0.49	-0.44	-0.56	-0.65	—
	CX-1010-SD	0.1 K	325 K	1.08 mm high × 1.905 mm wide × 3.175 mm long	40 mg	—	—	—	—	—	—
	CX-1010-AA	0.1 K	325 K	3.048 mm dia. × 8.509 mm long	400 mg	—	—	—	—	—	—
	CX-1030-BC	0.30 K	325 K	3.175 mm × 8.89 mm × 7.620 mm	3.0 mg	-1.15	-0.71	-0.56	-0.63	-0.64	—
	CX-1030-SD-HT	0.30 K	420 K	1.08 mm high × 1.905 mm wide × 3.175 mm long	40 mg	—	—	—	—	—	—
	CX-1030-AA	0.30 K	325 K	3.048 mm dia. × 8.509 mm long	400 mg	—	—	—	—	—	—
	CX-1050-BC	1.4 K	325 K	3.175 mm × 8.89 mm × 7.620 mm	3.0 mg	-2.5	-1.3	-0.9	-0.91	-0.87	—
	CX-1050-SD-HT	1.4 K	420 K	1.08 mm high × 1.905 mm wide × 3.175 mm long	40 mg	—	—	—	—	—	—
	CX-1050-AA	1.4 K	325 K	3.048 mm dia. × 8.509 mm long	400 mg	—	—	—	—	—	—
	CX-1070-BC	4.2 K	325 K	3.175 mm × 8.89 mm × 7.620 mm	3.0 mg	—	-1.5	-1	-1	-0.9	—
	CX-1070-SD-HT	4.2 K	420 K	1.08 mm high × 1.905 mm wide × 3.175 mm long	40 mg	—	—	—	—	—	—
	CX-1070-AA	4.2 K	325 K	3.048 mm dia. × 8.509 mm long	400 mg	—	—	—	—	—	—
	CX-1080-BC	20 K	325 K	3.175 mm × 8.89 mm × 7.620 mm	3.0 mg	—	—	-1.5	-1.4	-1.2	—
CX-1080-SD-HT	20 K	420 K	1.08 mm high × 1.905 mm wide × 3.175 mm long	40 mg	—	—	—	—	—	—	
CX-1080-AA	20 K	325 K	3.048 mm dia. × 8.509 mm long	400 mg	—	—	—	—	—	—	
Germanium	GR-50-AA	0.05 K	5 K	3.048 mm dia. × 8.509 mm long	355 mg	-0.74	-0.32	—	—	—	—
	GR-300-AA	0.3 K	100 K	3.048 mm dia. × 8.509 mm long	355 mg	-1.8	-1.2	-0.93	-1.1	—	—
	GR-1400-AA	1.4 K	100 K	3.048 mm dia. × 8.509 mm long	355 mg	-3.7	-2.1	-2.4	-1.1	—	—
ULT Rox <sup>™</sup>	RX-102B-RS	0.005 K	40 K	17.30 mm high × 7.21 mm wide × 7.21 mm long	3.5 g	-0.16	-0.11	-0.12	—	—	—
Interchangeable Rox <sup>™</sup>	RX-102A-BR	0.05 K	40 K	1.45 mm × 1.27 mm × 0.65 mm thick	2.8 mg	-0.47	-0.25	-0.07	—	—	—
	RX-102A-AA	0.05 K	40 K	3.048 mm dia. × 8.509 mm long	350 mg	-0.47	-0.25	-0.07	—	—	—
	RX-202A-AA	0.05 K	40 K	3.048 mm dia. × 8.509 mm long	350 mg	-0.34	-0.17	-0.10	—	—	—
	RX-103A-BR	1.4 K	40 K	1.40 mm × 1.23 mm × 0.41 mm thick	3.7 mg	-0.62	-0.36	-0.17	—	—	—
	RX-103A-AA	1.4 K	40 K	3.048 mm dia. × 8.509 mm long	350 mg	-0.62	-0.36	-0.17	—	—	—
Platinum	PT-102	14 K	873 K	2.007 mm dia. × 20.995 mm long	250 mg	—	—	+0.74	+1.6	+1.1	+1.0
	PT-103	14 K	873 K	1.6 mm dia. × 12.192 mm long	120 mg	—	—	+0.74	+1.6	+1.1	+1.0
	PT-111	14 K	673 K	1.8 mm dia. × 5 mm long	52 mg	—	—	+0.74	+1.6	+1.1	+1.0
Capacitance	CS-501-GR	1.4 K	290 K	3.048 mm dia. × 8.484 mm long	260 mg	+0.01	+0.02	+0.11	+0.46	-4.4	—
Thermocouples	Type K	3.2 K	1543 K	30 AWG (0.254 mm) and 36 AWG (0.127 mm)	NA						
	Type E	3.2 K	953 K	30 AWG (0.254 mm) and 36 AWG (0.127 mm)							

<sup>1</sup> Adapters will increase thermal response times—see individual sensor specifications for thermal response times



Sensor package size versus temperature sensor characteristics

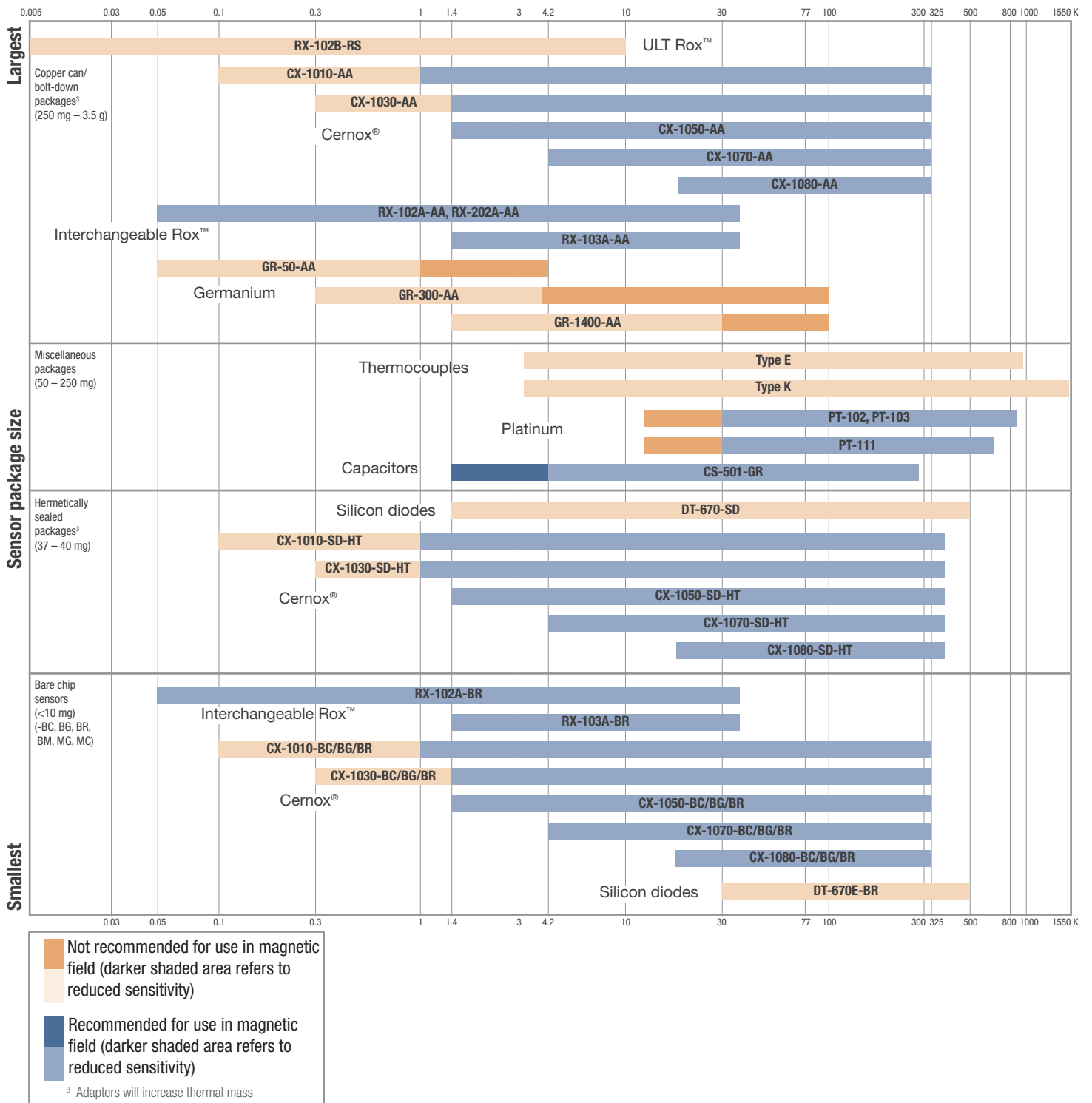



## Short and long term sensor characteristics

	Interchangeability	Typical reproducibility at 4.2 K	Typical long-term stability	
			Use to 305 K <sup>4</sup>	Use to 500 K <sup>5</sup>
Silicon diode	Yes—see page 18	±10 mK	4.2 K: ±10 mK/yr 77 K: ±40 mK/yr 305 K: ±25 mK/yr	4.2 K: ±40 mK/yr 77 K: ±100 mK/yr 305 K: ±50 mK/yr 500 K: ±150 mK/yr
Cernox <sup>®</sup>	No	±3 mK	1 K to 100 K: ±25 mK/yr 100 K to 300 K: 0.05% of T	
Germanium	No	±0.5 mK	4.2 K: ±1 mK/yr 77 K: ±10 mK/yr	
ULT Rox <sup>™</sup>	No	±15 mK	4.2 K: ±30 mK/yr	
Interchangeable Rox <sup>™</sup>	Yes	±15 mK	4.2 K: ±15 to 50 mK/yr (model dependent)	
Platinum	Yes—see page 18	±5 mK <sup>6</sup>	77 K to 273 K: ±10 mK/yr	
Capacitance	No	±0.01 K after cooling and stabilizing	±1.0 K/yr	
Thermocouples				
Type K	Yes—see ASTM standard	NA	NA	
Type E	Yes—see ASTM standard	NA	NA	

<sup>4</sup> Long-term stability data is obtained by subjecting sensor to 200 thermal shocks from 305 K to 77 K

<sup>5</sup> Based on 670 h of baking at 500 K

<sup>6</sup> Platinum reproducibility tested at 77 K

## Sensor characteristics in various environments

	Use in vacuum			Use in radiation <sup>7</sup>	Use in magnetic fields <sup>7</sup>
	High 10 <sup>-1</sup> to 10 <sup>-4</sup> Pa	Very high 10 <sup>-4</sup> to 10 <sup>-7</sup> Pa	Ultra high 10 <sup>-7</sup> to 10 <sup>-10</sup> Pa		
Silicon diode	DT-621	—	DT-670-SD	Not recommended	Not recommended for T<60 K, or for B>5 tesla above 60 K SD package has magnetic leads
Cernox <sup>®B</sup>	AA can	—	Bare chip SD	Recommended	Excellent for use in magnetic fields 1 K and up SD package with non-magnetic leads
Germanium <sup>B</sup>	AA can	—	Bare chip	Recommended	Not recommended for use except at low B due to large orientation-dependent magnetic field effect
ULT Rox <sup>™</sup>	RS	RS	—	Recommended	Not recommended for use in magnetic fields
Interchangeable Rox <sup>™</sup>	AA can	—	Bare chip	Recommended	Excellent for use in magnetic fields
Platinum	PT-103	PT-111	—	Recommended	Moderately orientation dependent—suggested use only T ≥ 30 K
Capacitance	CS-501	—	—	Not available	Recommended for control purposes
Thermocouples	Insulated wire	—	—	Recommended	Useful when T ≥ 10 K

<sup>7</sup> See additional information in Appendix A: Overview of Thermometry



**Typical magnetic field-dependent temperature errors,  $\Delta T/T$  (%), at B (magnetic induction)**

	T(K)	Magnetic flux density B				Notes
		2.5 T	8 T	14 T	19 T	
Cernox® 1050 (CX series)	2	1.3	3.1	3.9	5	Best sensor for use in magnetic field (T > 1 K)
	4.2	0.1	-0.15	-0.85	-0.8	
	10	0.04	-0.4	-1.1	-1.5	
	20	0.04	0.02	-0.16	-0.2	
	30	0.01	0.04	0.06	0.11	
	77	0.002	0.022	0.062	0.11	
	300	0.003	0.004	0.004	0.006	
Rox™ 102A	2	-1.4	-7.9	-13	-17	Recommended for use over the 0.05 K to 40 K temperature range. Consistent behavior between devices in magnetic fields.
	3	-1.5	-7	-14	-18	
	4	-0.56	-6.7	-14	-18	
	8	-1.3	-6.1	-13	-21	
	16	-0.40	-3.4	-9.6	-16	
	23	-0.31	-2.2	-6.2	-11	
Rox™ 102B	2	3.29	13.82	22.53	27.95	
	3	3.96	14.68	23.12	29.12	
	4	3.53	13.92	22.57	28.20	
	8	1.53	7.53	13.50	17.86	
	16	0.27	2.14	4.66	6.58	
	23	0.06	0.79	2.01	3.11	
Rox™ 103A	2	0.58	1.5	2.2	2.6	Excellent for use in magnetic fields from 1.4 K to 40 K. Predictable behavior.
	3	0.44	1.1	1.7	2.0	
	4	0.27	0.95	1.4	1.7	
	8	0.11	0.49	0.71	0.80	
	16	0.018	0.076	0.089	0.040	
	23	0.0051	0.0058	-0.0060	-0.095	
Rox™ 202A	2	-0.13	-2.2	-3.9	-5.2	Recommended for use over the 0.05 K to 40 K temperature range. Consistent behavior between devices in magnetic fields.
	3	0.18	-0.68	-2.7	-3.7	
	4	0.77	0.046	-1.8	-3.2	
	8	-0.023	0.16	-0.65	-3.0	
	16	0.03	0.16	-0.48	-1.5	
	23	-0.05	-0.08	-0.39	-0.92	
Platinum resistors (PT series)	20	20	100	250	—	Recommended for use when T ≥ 40 K.
	40	0.5	3	6	8.8	
	87	0.04	0.4	1	1.7	
	300	<0.01	0.02	0.07	0.13	
Capacitance CS-501-GR series		$\Delta T/T(\%) < 0.015$ at 4.2 K and 18.7 tesla				Recommended for control purposes.
		$\Delta T/T(\%) < 0.05$ at 77 K and 305 K and 18.7 tesla				
Germanium resistors (GR series)	2.0	-8	-60	—	—	Monotonic in C vs. T to nearly room temperature. Not recommended except at low B owing to large, orientation-dependent temperature effect.
	4.2	-5 to -20	-30 to -55	-60 to -75	—	
	10	-4 to -15	-25 to -60	-60 to -75	—	
	20	-3 to -20	-15 to -35	-50 to -80	—	
Type E thermocouples (chromel-constantan)	10	1	3	7	—	Useful when T ≥ 10 K. Refer to notes for Chromel-AuFe (0.07%).
	20	<1	2	4	—	
	455	<1	<1	2	—	

	T(K)	1 T	2 T	3 T	4 T	5 T	Notes
Silicon diodes Junction parallel to field (DT series)	4.2	-200	-300	-350	-400	-500	Strongly orientation dependent.
	20	-10	-20	-25	-30	-40	
	40	-4	-6	-8	-10	-12	
	60	-0.5	-1	-2	-3	-3.5	
	80	<0.1	-0.5	-0.8	-1.1	-1.5	
	300	<0.1	<-0.1	<-0.1	<-0.1	<-0.1	
Silicon diodes Junction perpendicular to field (DT series)	4.2	-8	-9	-11	-15	-20	Strongly orientation dependent.
	20	-4	-5	-5	-5	-10	
	40	-1.5	-3	-4	-5	-5.5	
	60	-0.5	-1	-2	-3	-3.5	
	80	-0.1	-0.3	-0.5	-0.6	-0.7	
	300	<0.1	0.2	0.5	0.6	0.6	

## Typical accuracy\* (interchangeability): uncalibrated sensors

	0.05 K	0.5 K	1.4 K	2 K	4.2 K	10 K	20 K	25 K	40 K	70 K	100 K	305 K	400 K	500 K	670 K
<b>Silicon diode</b>															
DT-670-SD, Band A	—	—	—	±0.25 K	±0.25 K	±0.25 K	±0.25 K	±0.25 K	±0.25 K	±0.25 K	±0.25 K	±0.5 K	±0.5 K	±0.5 K	—
DT-670-SD, Band B	—	—	—	±0.5 K	±0.5 K	±0.5 K	±0.5 K	±0.5 K	±0.5 K	±0.5 K	±0.5 K	±0.5 K	±0.33% of temp	±0.33% of temp	—
DT-670-SD, Band C	—	—	—	±1.0 K	±1.0 K	±1.0 K	±1.0 K	±1.0 K	±1.0 K	±1.0 K	±1.0 K	±1.0 K	±0.5% of temp	±0.5% of temp	—
DT-670-SD, Band D	—	—	—	—	—	—	—	±0.25 K	±0.25 K	±0.25 K	±0.25 K	±0.50 K	±0.2% of temp	±0.2% of temp	—
DT-670-SD, Band E	—	—	—	—	—	—	—	±0.25 K	±0.25 K	±0.25 K	±0.25 K	±0.25% of temp	±0.25% of temp	±0.25% of temp	—
<b>Platinum</b>															
PT-102	—	—	—	—	—	—	—	—	—	±1.3 K	±1.2 K	±0.5 K	±0.9 K	±1.4 K	±2.3 K
PT-103	—	—	—	—	—	—	—	—	—	±1.3 K	±1.2 K	±0.5 K	±0.9 K	±1.4 K	±2.3 K
PT-111	—	—	—	—	—	—	—	—	—	±1.3 K	±1.2 K	±0.5 K	±0.9 K	±1.4 K	±2.3 K
<b>Rox™</b>															
RX-102A-AA	±10 mK	±25 mK	±50 mK	±75 mK	±125 mK	±300 mK	±1.25 K	±1.5 K	±4.0 K	—	—	—	—	—	—
RX-102A-AA-M	±5 mK	±20 mK	±25 mK	±40 mK	±75 mK	±200 mK	±500 mK	±750 mK	±1.5 K	—	—	—	—	—	—
RX-202A-AA	±15 mK	±30 mK	±100 mK	±125 mK	±250 mK	±1 K	±2.5 K	±3 K	±5.0 K	—	—	—	—	—	—
RX-202A-AA-M	±10 mK	±25 mK	±50 mK	±75 mK	±150 mK	±500 mK	±1.0 K	±1.5 K	±2.0 K	—	—	—	—	—	—
RX-103A-AA	—	—	±150 mK	±180 mK	±400 mK	±1 K	±2.0 K	±2.5 K	±4.0 K	—	—	—	—	—	—
RX-103A-AA-M	—	—	±50 mK	±75 mK	±100 mK	±300 mK	±700 mK	±1 K	±1.5 K	—	—	—	—	—	—

## Typical accuracy\*: SoftCal™ (2-point and 3-point soft calibration sensors)

	2 K	4.2 K	10 K	30 K	70 K	305 K	400 K	475 K	500 K	670 K
<b>Platinum</b>										
PT-102-2S <sup>9</sup>	—	—	—	—	±0.25 K	±0.25 K	±0.9 K	±1.3 K	±1.4 K	±2.3 K
PT-103-2S <sup>9</sup>	—	—	—	—	±0.25 K	±0.25 K	±0.9 K	±1.3 K	±1.4 K	±2.3 K
PT-111-2S <sup>9</sup>	—	—	—	—	±0.25 K	±0.25 K	±0.9 K	±1.3 K	±1.4 K	±2.3 K
PT-102-3S <sup>10</sup>	—	—	—	—	±0.25 K	±0.25 K	±0.25 K	±0.25 K	±1.4 K	±2.3 K
PT-103-3S <sup>10</sup>	—	—	—	—	±0.25 K	±0.25 K	±0.25 K	±0.25 K	±1.4 K	±2.3 K
PT-111-3S <sup>10</sup>	—	—	—	—	±0.25 K	±0.25 K	±0.25 K	±0.25 K	±1.4 K	±2.3 K

<sup>9</sup>2S (2-point at 77 K and 305 K)<sup>10</sup>3S (3-point at 77 K, 305 K, and 480 K)

\*The use of the terms accuracy and uncertainty throughout this catalog are used in the more general and conventional sense as opposed to following the strict metrological definitions. For more information, see Appendix B: Accuracy versus Uncertainty, page 158.

Typical accuracy\*: calibrated sensors (in mK)<sup>12</sup>

	Temperature												
	0.05 K	0.1 K	0.3 K	0.5 K	1 K	1.4 K	4.2 K	10 K	20 K	77 K	300 K	400 K	500 K
<b>Silicon diode</b>													
DT-670	—	—	—	—	—	±21 mK	±12 mK	±12 mK	±14 mK	±34 mK	±35 mK	±50 mK	±54 mK
<b>Cernox®</b>													
CX-1010	—	±4 mK	±4 mK	±4 mK	±5 mK	±5 mK	±5 mK	±6 mK	±11 mK	±25 mK	±79 mK	±125 mK	—
CX-1030	—	—	±4 mK	±4 mK	±5 mK	±5 mK	±5 mK	±6 mK	±9 mK	±25 mK	±75 mK	±96 mK	—
CX-1050	—	—	—	—	—	±5 mK	±5 mK	±6 mK	±9 mK	±16 mK	±49 mK	±77 mK	—
CX-1070	—	—	—	—	—	—	±5 mK	±6 mK	±9 mK	±16 mK	±48 mK	±75 mK	—
CX-1080	—	—	—	—	—	—	—	—	±9 mK	±16 mK	±40 mK	±65 mK	—
<b>Rox™</b>													
RX-102A/103A/202A	±4 mK	±4 mK	±4 mK	±4 mK	±5 mK	±5 mK	±17 mK	±22 mK	±38 mK	—	—	—	—
<b>Platinum</b>													
PT-103/111	—	—	—	—	—	—	—	—	±10 mK	±12 mK	±26 mK	±48 mK	±58 mK
<b>Germanium</b>													
GR-50/300/1400	±5 mK	±5 mK	±5 mK	±5 mK	±6 mK	±6 mK	±6 mK	±4 mK	±8 mK	±25 mK	—	—	—

<sup>12</sup>All accuracies are: 2 σ figures; [(calibration uncertainty)<sup>2</sup> + (reproducibility)<sup>2</sup>]<sup>0.5</sup>; for additional information, please see Appendix D.



## Sensor Packages and Mounting Adapters

Temperature sensors are available in a variety of packages to facilitate mounting. Included are adapters that allow the sensor to be soldered in place, screwed on, bolted down, inserted into a hole, or inserted through a pressure seal in the form of a thermowell. Gold-plated copper bobbins are available for both diodes and resistors in order to heat sink leads. The chart below summarizes the standard Lake Shore sensor and packaging configurations. Appendix C: Sensor Packaging and Installation discusses techniques for the correct installation of temperature sensors. More specific installation notes are included for the bare chip sensors, the SD package, and the CU, DI, CY, and CD adapters. Special packaging is also available—consult Lake Shore for custom orders.

Packaging (see individual sensor pages for additional details)							Installation instructions	
		Silicon diode	Cernox®	Germanium	Interchangeable Rox™	PT-103 PT-111		
<b>Common</b>								
Bare chip sensors								
BC	Bare chip with 2 copper leads (42 AWG)		■				Appendix C	
BG	Bare chip with 2 or 4 gold leads		■				Appendix C	
BR	Bare chip, no leads		■		■		Appendix C	
Hermetically sealed package								
SD		■	■				Appendix C	
Mounting adapters for SD								
CO	Clamp	■	■				Appendix C	
ET	Screw-in	■	■				Order from Lake Shore	
MT	Screw-in (metric)	■	■				Order from Lake Shore	
CU	Copper bobbin (small, 4-lead)	■	■				Appendix C	
DI	Copper bobbin (small, 2-lead)	■					Appendix C	
CY	Copper bobbin (large, 2-lead)	■					Appendix C	
LR	Half-rounded cylinder	■	■				Order from Lake Shore	
BO	Beryllium oxide heat sink block	■	■				Order from Lake Shore	
Platinum mounting adapter								
AM					■		Order from Lake Shore	
Copper canister package								
AA			■	■	■		Appendix C	
CD	Copper bobbin		■	■	■		Appendix C	
<b>Unique packages</b>								
See individual sensor specifications					■	■	■	Order from Lake Shore



Packages

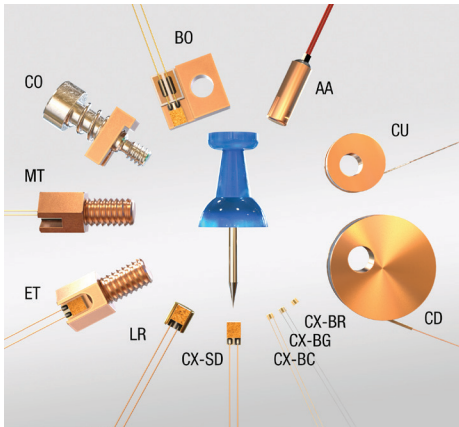

Cernox® packages

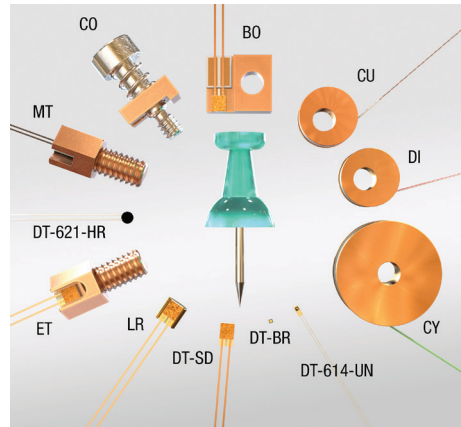

Silicon diode packages

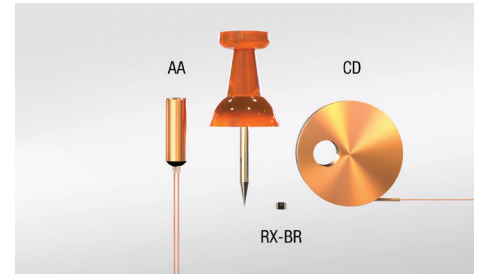

Interchangeable Rox™ packages

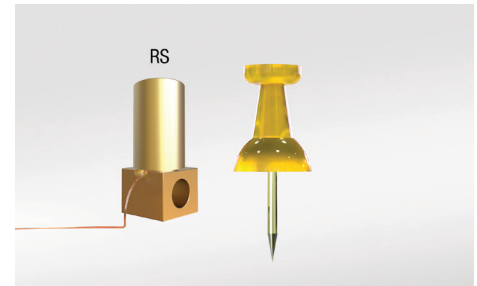

Ultra low temperature Rox™ package

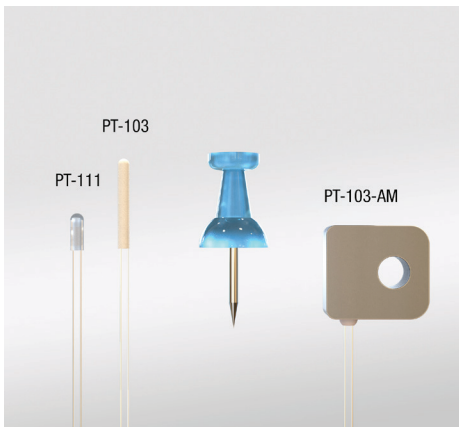

Platinum packages



Capacitance package

Unique packages

see individual sensor pages

- PT-103 CX-10XX-BC
- PT-111 CX-10XX-BG
- CX-10XX-BR
- RX-102B-RS

# The Lake Shore Hermetically Sealed SD Package

SD

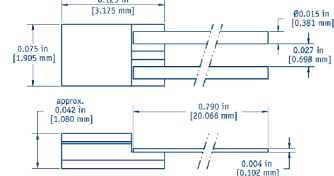

General tolerance of ±0.005 in [±0.127 mm] unless otherwise noted

- Small package designed primarily for bonding or clamping to a flat surface
- Indium, silver epoxy, 2850 Stycast® epoxy, or a CO clamp may be used for mounting

- Leads: 2
- Lead material: Silicon diode: brazed Kovar  
Cernox®: gold-plated copper soldered with 60/40 SnPb
- Mass: 0.03 g
- Limitation: The useful upper temperature limit of this configuration is 500 K

SD (Cernox®)

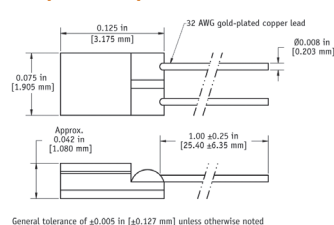

General tolerance of ±0.005 in [±0.127 mm] unless otherwise noted

The Lake Shore SD package—the most rugged, versatile package in the industry

The SD package, with its sapphire base, direct sensor-to-sapphire mounting, hermetic sealing, and brazed Kovar leads provides the industry's most rugged, versatile sensors with the best thermal connection between the sample and sensor chip. In addition, this package is designed so heat coming down the leads bypasses the sensor chip. It can survive several thousand hours at 500 K and is compatible with most ultra high vacuum applications, and can be indium soldered to samples. The Lake Shore SD package is now available with Cernox® resistors as well as silicon diodes. For Cernox resistors the Kovar leads are replaced with nonmagnetic leads.

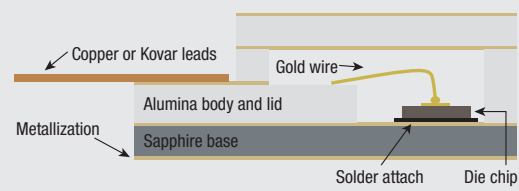

## Mounting adapters for SD package—CO, CU, DI, CY, LR, BO, ET, MT

### CO

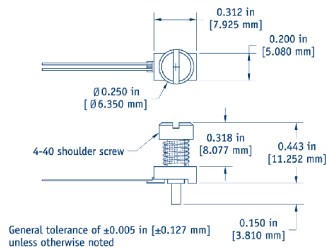

- Spring-loaded clamp holds standard SD sensor in contact with the surface of the sample and allows the sensor to be easily changed or replaced
- Extra clamps are available for frequent relocation of the sensor
- 4-40 stainless steel screw has a formed shoulder, thus applying correct pressure to the clamp

Adapter material: Gold-plated copper (nickel strike); spring is ASTM A313 302 Austenitic steel

Leads: See SD package

Lead material: See SD package

Mass: 1.8 g (including SD package and clamp)

Limitation: The useful upper temperature limit of this configuration is 500 K

### CU/CU-HT & DI

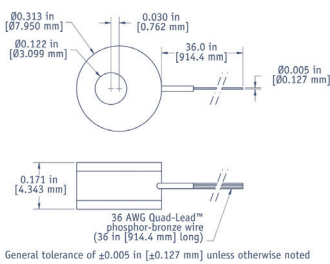

- SD packaged sensor indium-soldered into a flat copper bobbin with the leads thermally anchored to that same bobbin
- HT (high temperature) version is soldered using high temperature (90% Pb, 10% Sn) solder
- Can be mounted to any flat surface with a 4-40 screw

### DI

- 2-lead version of the CU

Adapter material: Gold-plated copper bobbin (SD indium-soldered to adapter and wrapped in Stycast® epoxy); high temperature CU uses high temperature (90% Pb, 10% Sn) solder

CU leads: Four 0.91 m (36 in), 36 AWG, color-coded Quad-Lead™

DI leads: 0.91 m (36 in), 36 AWG, color-coded, 2-lead ribbon cable

Lead material: Phosphor bronze alloy

Mass: 1.1 g (including SD package and bobbin, excluding leads)

Limitation: The epoxy limits the upper useful temperature of this configuration to 378 K (high temperature CU-HT upper temperature limit is 420 K with Cernox® and 500 K with silicon diodes)

### CY

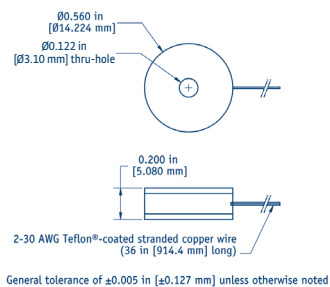

- Similar to the DI package, except the bobbin is larger in diameter with a centered mounting hole
- Relatively large-sized, robust

Adapter material: Gold-plated copper bobbin (SD indium-soldered to adapter and wrapped in Stycast® epoxy)

Leads: Two 0.91 m (36 in), 30 AWG Teflon®-coated leads

Lead material: Stranded copper

Mass: 4.3 g (Including SD package and bobbin, excluding leads)

Limitation: The epoxy limits the upper useful temperature of this configuration to 400 K



LR

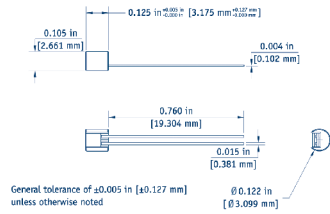

- With an SD packaged sensor mounted on a slightly-more-than half-rounded cylinder, this package is designed to be inserted into a 3.2 mm (1/8 in) diameter hole

Adapter material: Gold-plated flat cylindrical copper disk (SD indium-soldered to adapter)  
 Leads: See SD package  
 Lead material: See SD package  
 Mass: 0.2 g (Including SD package and disk)  
 Limitation: Indium solder limits the upper useful temperature of this configuration to 420 K

BO

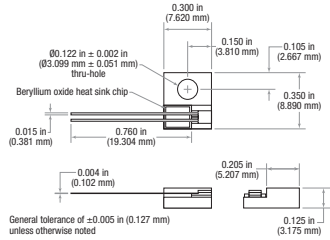

- SD package is soldered to a mounting block and the leads are thermally anchored (without epoxy) to the block via a beryllium oxide insert
- Since leads can be a significant heat path to the sensing element and can lead to measurement errors when incorrectly anchored, this configuration helps maintain the leads at the same temperature as the sensor

Adapter material: Gold-plated bolt-on copper block with leads thermally anchored to block (SD indium-soldered to adapter)  
 Leads: See SD package  
 Lead material: See SD package  
 Mass: 1.5 g (including SD package and mounting block)  
 Limitation: Indium solder limits the upper useful temperature of this configuration to 420 K

ET

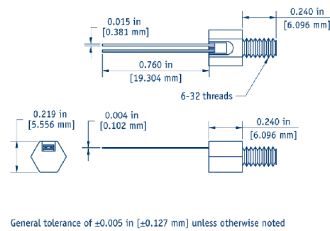

- Convenient screw-in package formed by indium-soldering a basic SD configuration into a recess in one flat of a hexagonal screw head
- The head terminates in a standard SAE 6-32 threaded stud allowing the sensor to be threaded into a mounting hole in the sample

Adapter material: ET: gold-plated copper SAE-threaded screw head #6-32  
 MT: gold-plated copper metric threaded screw head 3 mm x 0.5 metric  
 Leads: See SD package  
 Lead material: See SD package  
 Mass: 1.5 g (including SD package and screw head)  
 Limitation: Indium solder limits the upper useful temperature of this configuration to 420 K

MT

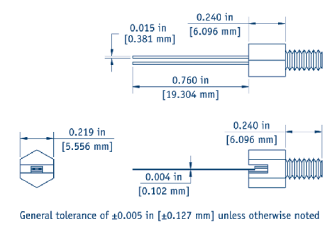

- The MT package is similar to the ET version except the SD package is mounted in a slot in the center of the hexagonal head and the stud is a 3 mm x 0.5 metric thread

*Note: A light coating of vacuum grease on the threads further enhances the thermal contact between the sensor package and the sample.*

## Copper canister packages

### AA

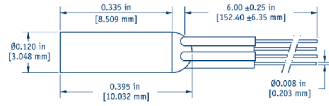

General tolerance of  $\pm 0.005$  in ( $\pm 0.127$  mm) unless otherwise noted

- Used with Cernox®, germanium, and Rox™ sensors

Adapter material:

Gold-plated cylindrical copper canister, BeO header, Stycast® epoxy

Leads:

Four 32 AWG  $\times$  152 mm (6 in) long  
(Rox™: Two 32 AWG  $\times$  152 mm [6 in] long)  
Phosphor bronze insulated with polyimide  
(Rox™: copper insulated with Formvar®)

Lead material:

Mass:

AA canister (empty): 0.091 g  
B canister (empty): 0.080 g  
Once sensors are installed, total mass increases to 0.197 g to 0.416 g. Refer to individual sensor specifications.

Limitation:

The epoxy limits the upper useful temperature of this configuration to 400 K

### B

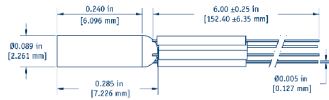

General tolerance of  $\pm 0.005$  in ( $\pm 0.127$  mm) unless otherwise noted

- Used only with germanium sensors

## Mounting adapter for AA canister package

### CD

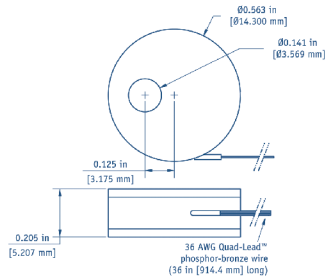

General tolerance of  $\pm 0.005$  in ( $\pm 0.127$  mm) unless otherwise noted

- AA canister sensor soldered into a flat, copper bobbin with the sensor leads thermally anchored to the bobbin
- Can be mounted to any flat surface with a 6-40 screw (not supplied)
- Used with Cernox®, Germanium, and Rox™ sensors

Adapter material:

Copper bobbin, gold-plated (AA canister epoxied to bobbin with Stycast® epoxy)

Leads:

0.91 m (36 in), 36 AWG, color-coded, Quad-Lead™  
Phosphor bronze Grade A alloy

Lead material:

Limitation:

The epoxy limits the upper useful temperature of this configuration to 378 K

## Mounting adapter for platinum RTDs

### PT-103-AM

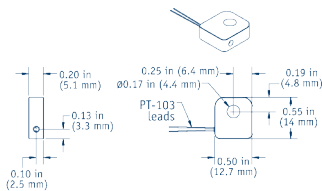

General tolerance of  $\pm 0.010$  in ( $\pm 0.254$  mm) unless otherwise noted

- PT-103 mounted into a flat aluminum block
- Can be mounted to any flat surface with a 6-32 or M3 screw (not included) and Inconel® Belleville washer (included)

Adapter material:

6061 Al block (PT mounted to adapter using Cotronics Durabond® 950 Al-based adhesive)  
Two 0.010-inch diameter; 15.240  $\pm$  1.270 mm  
(0.600  $\pm$  0.050 in) long

Lead material:

Platinum

Mass:

2.1 g

Limitation:

The aluminum alloy limits the upper useful temperature of these configurations to 800 K





# Lead Extensions

(formerly SMODs)

Adding extra wire to your sensor leads can be cumbersome and time consuming. Lake Shore offers this service for you at the time of order, allowing numerous options to best suit your application.

There are various options available when selecting a lead extension:

## Number of wires

**4-wire:** For accurate sensor measurements, 4-lead connections are by far the superior option when adding a lead extension to both diodes and resistive temperature sensors. See Appendix C and Appendix E for additional information.

**2-wire:** This option is useful if the number of electrical connections inside a system must be kept to a minimum. However, 2-lead connections add measureable resistance to sensor measurements as described in Appendix E. This additional resistance will cause a significant (but repeatable) shift on all sensors except diodes.

## Wire type

**Phosphor bronze:** This all-purpose cryogenic wire has a great balance of features.

- Low thermal conductivity minimizes heat leak (lower is generally better)
- Moderate electrical resistance (lower is generally better)
- Non-ferromagnetic and very low magnetoresistance, making this wire the best choice for applications where magnetic fields are present
- Available in several convenient configurations in addition to single strand, such as Quad-Lead™ and Quad-Twist™

**Manganin:** This wire has several interesting characteristics that make it useful in certain situations.

- Coefficient of thermal expansion very close to that of pure copper
- Very low thermal conductivity minimizes heat leak (lower is generally better)
- Somewhat high electrical resistance (lower is generally better)
- Heavy Formvar® insulation limits upper temperature of wire to 378 K
- Non-ferromagnetic
- Available as single strand wire only

## Wire gauge

Wire gauge (AWG)	Wire diameter (in)	Wire diameter (mm)
30	0.01	0.255
32	0.00795	0.202
36	0.0055	0.127
42	0.0025	0.0635

Various wire thicknesses are available, depending on the wire type selected. The wire gauge selection process usually involves a compromise between thermal conductivity and ease-of-use, with thinner wire being preferred to reduce thermal conductivity and thicker wire being easier to handle and work with. Lake Shore uses American wire gauge (AWG) for its wire. This conversion table is provided for your convenience.

32 AWG and 36 AWG are our preferred wire gauges to use with cryogenic sensors. By far they provide the best balance between reduced thermal conductivity and ease-of-use.

Manganin is the only wire type available in 30 AWG as the extremely low thermal conductivity of the wire helps compensate for the “large” cross-sectional area associated with 30 AWG.

Phosphor bronze is the only wire type available in 42 AWG. This wire thickness reduces thermal conductivity substantially to the levels possible with manganin, with the same low magnetoresistance of phosphor bronze. Unfortunately, this wire is extremely delicate and can break easily. Lake Shore suggests this wire be ordered only by users with extensive experience with system wiring.

## Wire length

Standard lengths of 2 m and 5 m are offered with all wire types and gauges. These lengths have been selected to suit a wide range of applications, most commonly wiring from a temperature sensor through the various stages of a cryostat, up to and terminating at an electrical feedthrough. Additional wire may be trimmed from both of these wire lengths if necessary. However, if a custom length is required, please contact Lake Shore to discuss custom wire lengths.

## Component temperature limits

The lead extension components have different maximum temperatures. Use this chart to ensure the lead extensions you order are appropriate for your given application.

Lead extension component	Maximum temperature
Formvar	378 K (105 °C)
Bond Coat 999	433 K (160 °C)
Polyimide	500 K (227 °C)
63/37 Solder	450 K (177 °C)
90/10 Solder	548 K (275 °C)



### Recommended standard lead extensions

Lake Shore recommends selecting from one of these two configurations — our most popular configurations due to the wide range of applications they cover.

#### -QL

Quad-Lead™ phosphor bronze, 32 AWG, 2 m

For situations where ease-of-use and ruggedness is important.

- 32 AWG wire is easier to prepare and solder to than thinner gauges
- Quad-lead™ wire is easy to heat-sink around copper bobbins due to its ribbon structure
- Polyimide insulation is strong and is resistant to solvents, and also has a high temperature rating that protects it from heating that might be applied to help soften the bonding agent used to join the wires to one another

#### -QT

Quad-Twist™ phosphor bronze, 36 AWG, 2 m

For noisy environments where signal integrity must be protected.

- Quad-twist™ wire helps reject electromagnetic interference that may be present inside the measurement space
- 32 AWG wire is easier to prepare and solder to than thinner gauges
- Quad-twist™ can be slightly more difficult to heat-sink, but the 36 AWG wire reduces thermal conductivity and therefore reduces heat-leak naturally
- Formvar® insulation has excellent mechanical properties such as abrasion resistance and flexibility, which is important when using 36 AWG wire. However, care should be taken as Formvar® can craze when exposed to solvents.

There are certain scenarios where these standard offerings are not adequate and alternative solutions should be selected. One such example is higher-temperature applications above 450 K where both Quad-Lead™ wire and Formvar® insulation become inappropriate. This application would require Quad-Twist, 32 AWG. In this scenario, please use the full part configurations to define the lead extension.

#### -XXYY-Z

**XX** = Wire type

**YY** = Wire gauge (AWG)

**Z** = Length in meters

#### Method of ordering

When ordering a lead extension on the website, add the sensor to the shopping cart first, and then come to this page to add a lead extension.

If placing a purchase order, please append the lead extension part number to the sensor that requires the extension. Examples:

CX-1050-SD-HD-4L-QL	Quad-Lead™, 32 AWG, 2 m
DT-670-CU-HT-1.4L-QT	Quad-Twist™, 36 AWG, 2 m attached to 0.91 m of Quad-Twist™, 36 AWG wire that comes standard with the diode CU-HT package.
PT-102-14L-QT32-5	Quad-Twist™, 32 AWG, 5 m
DT-670C-SD-DT32-2	Duo-Twist™, 32 AWG, 2 m

*Lead extensions are not available on devices with gold or no leads*

For more information please visit [www.lakeshore.com](http://www.lakeshore.com).



# Temperature Probes

## Temperature probe features

- Stainless steel-encased probes that provide highly reliable sensor performance in a thermowell or direct cryogen contact
- Highly customizable to suit your particular application
- May be configured with many sensor types, including Cernox® for superior temperature performance from room temperature down to 4 K (-269.15 °C) and below
- Thin-walled probe tubing reduces thermal lag and heat leak from outside the measurement space
- Ideal for temperature measurements in fluid containers and tanks
- Full 3-year standard warranty

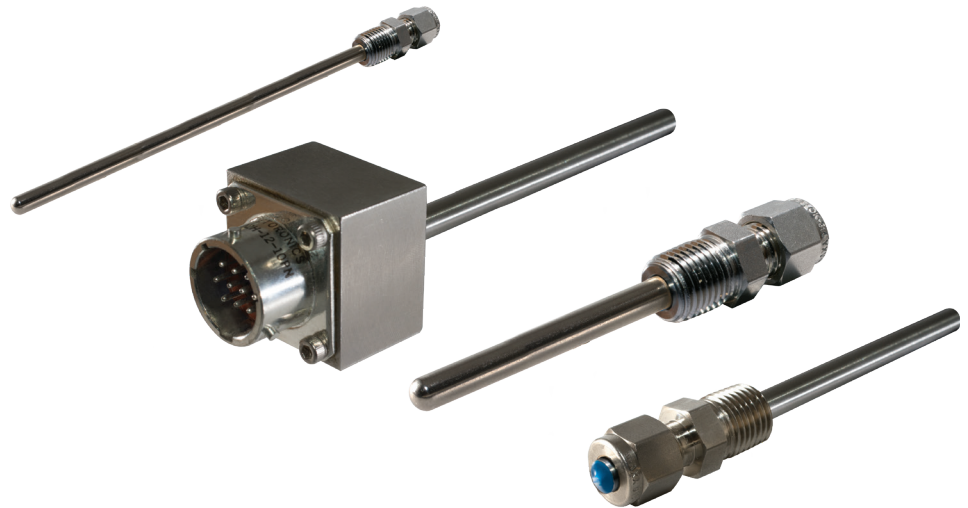

Lake Shore offers a variety of temperature sensors in packages that enable mounting in very tight areas. But for some applications (especially if the sensors have to be immersed in liquid) you need to do more to protect the sensor circuitry. For these applications, a cryogenic temperature probe is the optimum choice. Encased in one of these stainless steel thermowell fixtures, the sensor can perform as designed, unaffected by high pressure and sealed to keep electrical components and wiring protected from fluids and other elements.

## Typical applications

Lake Shore temperature probes are ideal for thermometry applications where you need to measure inside:

- fluid containers, tanks, and pipes
- cryostats and cryogenic liquid flow meters
- other liquid storage systems.

## Highly customizable

Lake Shore temperature probes are made-to-order with a wide range of configuration options available. These include:

- Multiple sensor types including our extremely popular Cernox® RTDs and DT-670 diodes
- Either 1/8 in or 1/4 in stem diameter in lengths up to 0.71 m (28 in) are standard
- Various mounting adapters suited for either positive or negative pressures, if required
- Numerous connectivity options including wire types and lengths as well as various terminating connectors for direct connection to Lake Shore temperature instruments or third party equipment

If you do not see an option available as part of our standard offerings, please contact Lake Shore to discuss further customization options.

## Specifications

**Note:** These probes are not designed to be intrinsically safe. It is the responsibility of the user to operate these probes safely in explosive environments.

### Probe construction

#### Stem

**Material:** 316 stainless steel (non-magnetic)<sup>1</sup>

	Wall thickness	Maximum length
<b>1/4 in stem</b>	0.028 in $\pm$ 0.003 in	28 in*
<b>1/8 in stem</b>	0.010 in $\pm$ 0.001 in	20 in

<sup>2</sup>Not suitable for direct immersion in liquid oxygen or hydrogen environments.

<sup>3</sup>Longer lengths may be possible depending on the overall configuration. Please contact Lake Shore to discuss.

#### Internal components

**Internal atmosphere:** Air

**Internal atmosphere pressure:** 98 kPa (14.2 psia)

**Internal sensor wire:** Quad-Twist™ 4-lead 36 AWG phosphor bronze wire with polyimide insulation

### Probe mount

#### Swagelok® fittings

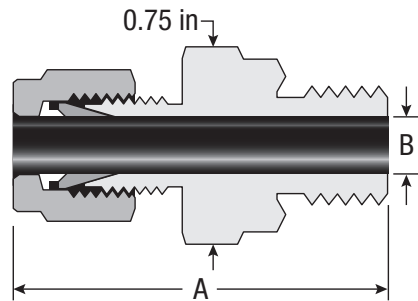

	1/4 in probe	1/8 in probe
<b>Swagelok® part number:</b>	SS-400-1-4BT	SS-200-1-2BT
<b>Material</b>	316 stainless steel	
<b>Thread</b>	0.25 in NPT male	0.125 in NPT male
<b>A</b>	1.59 in	1.5 in
<b>B</b>	0.25 in	0.125 in

#### CF flange

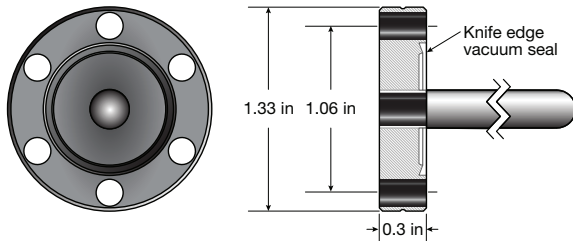

**Material:** 304L stainless steel

**Flange size:** 1 1/3 in (DN16)

**Vacuum rating:**  $1 \times 10^{-13}$  torr ( $<1.3 \times 10^{-13}$  mbar)\*

\*Requires the use of appropriate bolts, gasket and mating surface.

### Connectors

#### BNC connector

Standard male BNC connector. When ordering with 4-lead wire, two separate BNC connectors will be provided to maintain the 4-lead measurement.

#### Configuration:

	BNC 1		BNC 2	
	Center pin	Shield	Center pin	Shield
2-lead cable	I/V+ (anode)	I/V- (cathode)	—	—
4-lead cable	I+	I-	V+	V-

#### 10-pin Detronics® connector

The Detronics connector is o-ring sealed to the temperature probe.

**Note:** This connector is mounted directly to the probe, meaning that no external cable can be selected with this option. It also eliminates the CF flange probe mount option.

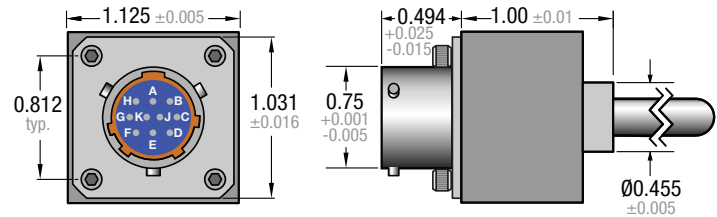

#### General specifications

**Air leakage:**  $1 \times 10^{-6}$  cm<sup>3</sup>/s at 15 psi

**Insulation resistance:** 5,000 MΩ at 500 VDC

**Operating temperature:** -55 °C to +125 °C (-67 °F to +257 °F)

Finish is tin-plated shell and pins.

#### Materials

**Shell, bayonet and flange:** Carbon steel

**Pins:** 52 nickel alloy

**Insulator:** Glass

#### 25-pin D-sub connector

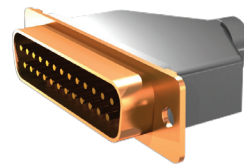

The 25-pin D-sub is required to connect directly to particular Lake Shore temperature monitors.

#### Supported instruments:

- Model 211
- Model 218

#### 6-pin DIN connector



The 6-pin DIN is required to connect directly to particular Lake Shore temperature controllers and monitors.

#### Supported current instruments:

- Model 350
- Model 336
- Model 335
- Model 224

#### Supported discontinued instruments:

- Model 340
- Model 331/332
- Model 330 (diodes only)
- Model 321 (silicon diodes only)



### Connector configurations

Connector type	I+	V+	I-	V-	Shield*
2-lead BNC (1 connector)	Center pin		Outer cup (shield)		Not connected
4-lead BNC (2 connectors)	Center pin of 'I' BNC	Center pin of 'V' BNC	Outer cup of 'I' BNC	Outer cup of 'V' BNC	Not connected
10-pin probe-mounted Detronics connector®	Pin A	Pin C	Pin B	Pin D	NA
6-pin DIN	Pin 5	Pin 4	Pin 1	Pin 2	Pin 6
25-pin D-sub	Pin 3	Pin 4	Pin 15	Pin 16	Pin 2

\*Shield connection is only used in conjunction with external cable choices that include a braided shield (Cryocable™ and instrument cable)

### Wire

#### Instrument cable

Robust 4-lead cable best for wiring to instrument where both the wire and instrument are at room temperature. The 30 AWG signal wires make these wires easier to work with than traditional cryogenic wire.

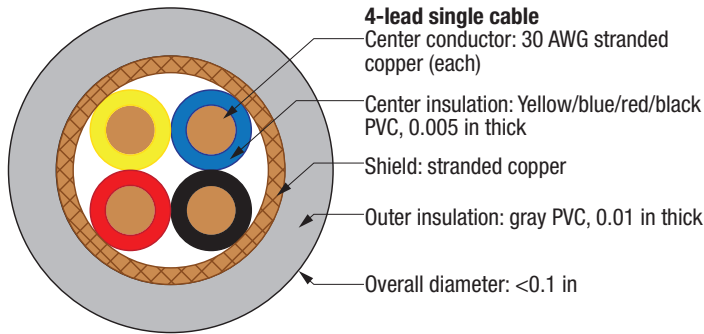

**Rated temperature:** -20 °C to 80 °C  
**Thermal conductivity (300 K):** 400 W/(m·K)  
**Resistance (300 K):** 0.32 Ω/m  
**Supported sensor types:** Cernox® RTD, silicon diode, GaAlAs diode, platinum RTD  
**Maximum rated temperature:** 378 K

### Cryogenic wire

Phosphor-bronze wire combinations that limit heat transfer into the temperature probe and are themselves rated for use in cryogenic environments.

	Quad-Twist™ 36 AWG*	Quad-Twist™ 32 AWG	Quad-Lead™ 32 AWG	Duo-Twist™ 32 AWG
Configuration	4-lead		2-lead	
Wire	Phosphor bronze			
Gauge	36 AWG	32 AWG		
Insulation	Formvar	Polyimide		
Structure	Two twisted pairs		Four wires formed into a ribbon using Bond Coat 999 bonding film	One twisted pair
Thermal conductivity (300 K)	48 W/(m·K)			
Resistance (300 K)	10.3 Ω/m	4.02 Ω/m		
Supported sensors	Cernox® RTD, silicon diode, GaAlAs diode, platinum RTD			Diodes only

\*Also used for internal probe wiring. Ordering this cable will result in a continuous length of wire from the sensor through to the outside environment.

#### SS (stainless steel) coaxial cable

2-lead cabling solution that is extremely robust and limits heat transfer into the probe. Due to the 2-lead configuration, this cable is only compatible with diode sensors and will cause a predictable (potentially insignificant) offset in any temperature readings.

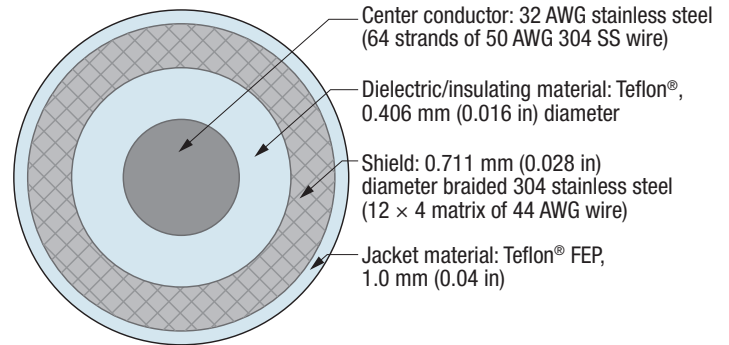

#### Electrical properties

**Resistance—center conductor at 295 K (22 °C):** 23.62 Ω/m (7.2 Ω/ft)  
**Resistance—shield at 295 K (22 °C):** 3.61 Ω/m (1.1 Ω/ft)  
**Insulation temperature range:** 10 mK to 473 K  
**Supported sensor types:** Silicon diode, GaAlAs diode, platinum RTD

## Cryocable™

A robust, 4-wire cable for use in cryogenic environments to room temperature for the ultimate in thermal isolation from external heat sources. This cable is designed around 32 AWG (203 µm) diameter superconductive wires consisting of a NbTi core (128 µm diameter) and a Cu-10% Ni jacket. The wire is LTS, requiring very low temperatures for it to become superconducting.

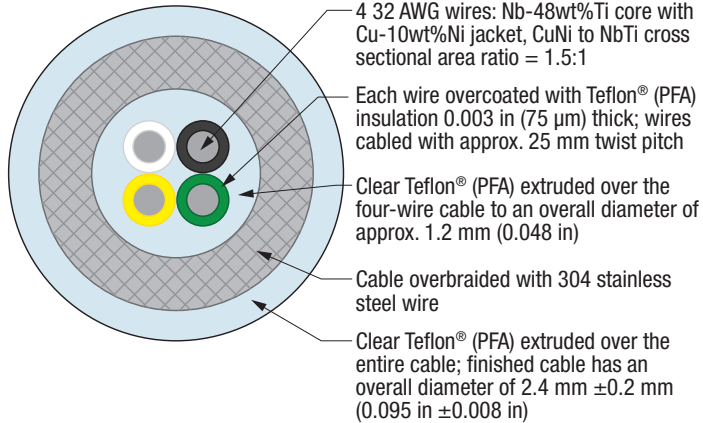

**Minimum bend radius:** 15 mm (0.6 in)

**Superconducting critical temperature:** 9.8 K

**Superconducting critical magnetic field:** 10 T

**Supported sensor types:** Cernox® RTD, silicon diode, GaAlAs diode, platinum RTD

Magnetic field	Critical current (per wire)
3 T	35 A
5 T	25 A
7 T	15 A
9 T	6 A

	Temperature (K)		
	295	77	4.2
Wire resistance (Ω/m)	9.2	8.4	0*
Overbraid resistance (Ω/m)	0.90	0.64	0.62
Thermal conductivity—entire cable assembly (W/(m-K))	7.6	2.8	0.17

\*Superconducting

## Wire configurations

Wire type	I+	V+	I-	V-	Shield
Instrument cable	Black	Yellow	Red	Blue	Copper braid
Quad-Twist™ 36 AWG	Green (from red/green pair)	Green (from clear/green pair)	Red	Clear	None
Quad-Twist™ 32 AWG	Red	Black	Green	Clear	None
Quad-Lead™ 32 AWG	Clear	Black	Red	Green	None
Duo-Twist™ 32 AWG	Clear		Green		None
Stainless steel coaxial	Center conductor		Shield		None
Cryocable™	Black	Yellow	White	Green	Stainless steel braid

### Instrument cable



### Quad-Twist™ 36 AWG



### Quad-Twist™ 32 AWG

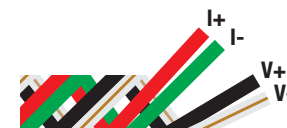

### Quad-Lead™ 32 AWG



### Duo-Twist™ 32 AWG



### Stainless steel coaxial

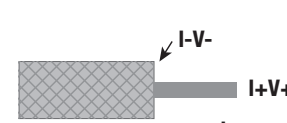

### Cryocable™



## Temperature sensors

See the individual Cernox, DT-670, and platinum sensor pages for specifications:

Sensor type	Installed sensor package
Cernox®	SD
DT-670	SD
Platinum	Standard PT-100 Series packages

All temperature sensor calibrations are performed before the device is installed into the probe. At this time, Lake Shore does not perform recalibrations on finished probes.



## Temperature probe ordering information

The easiest way to request a quote for a temperature probe is to use the online configurator at [www.lakeshore.com](http://www.lakeshore.com). Otherwise contact our Sales department at [sales@lakeshore.com](mailto:sales@lakeshore.com) and we can assist you.

## Specify TP-a-bcd-e-f-g, where:

**a = probe length in inches**—offered in whole inch increments from 1 to 28 inches

**b = tube diameter<sup>1</sup>**

<b>2</b>	1/8 in
<b>4</b>	1/4 in

<sup>1</sup> Probes over 20 inches long are only available in 1/4-inch diameter

**c = probe mount**

<b>N</b>	no probe mount adapter
<b>S</b>	Swagelok® fitting <sup>2</sup>
<b>F</b>	CF™ flange mount <sup>3</sup>

<sup>2</sup> For 1/8 in diameter probe, Swagelok® fitting uses a 1/8 in NPT male thread; for 1/4 in diameter probe, Swagelok® fitting uses a 1/4 in NPT male thread

<sup>3</sup> The CF™ flange is welded to the probe

**d = external cable/wire type<sup>4</sup>**

<b>N</b>	no external cable (usually used with Detronics connector)
<b>S</b>	S1 coaxial cable (2-lead)
<b>I</b>	30 AWG instrument cable (4-lead)
<b>T</b>	DT-32 (twisted pair of 32 AWG phosphor bronze wire)
<b>F</b>	QT-32 (two twisted pairs of 32 AWG phosphor bronze wire)
<b>Q</b>	QT-36 (two twisted pairs of 36 AWG phosphor bronze wire)
<b>L</b>	QL-32 (four 32 AWG wires in a ribbon configuration)
<b>C</b>	CryoCable™ (4-lead cryogenic coaxial cable)

<sup>4</sup> Lake Shore strongly recommends that all RTD temperature sensors use a 4-lead cable/wire type

**e = terminator**

<b>N</b>	no connector (leads stripped and tinned)
<b>B</b>	BNC connector
<b>D</b>	10-pin Detronics connector <sup>5</sup>
<b>Y</b>	25-pin D-shell connector for temperature monitors
<b>R</b>	connector wired for temperature instruments (6-pin round)

<sup>5</sup> Selecting a Detronics connector limits the following selections: **d** = N and **f** = 0; the Detronics connector is o-ring sealed to the probe

**f = external cable length**—offered in whole meter increments from 1 to 10 m (enter '0' for no external cable)

**g = temperature sensor type<sup>6</sup>**—specify sensor model number with calibration range, if applicable

<sup>6</sup> Due to indium solder use, all SD sensors have an upper temperature usage limit of 400 K

### Ordering example

**TP- 06 - 2FS - B - 03 - S27**

(6 in probe, 1/8 in diameter, flange, S1 coaxial cable, BNC connector, 3 m cable length, DT-670-SD calibrated 1.4 K to 325 K)

### Calibration range suffix codes

Numeric figure is the low end of the calibration Letters represent the high end: B = 40 K, D = 100 K, L = 325 K, H = 500 K

### Cernox® RTDs

<b>Uncalibrated</b>	<b>C01</b>	CX-1010-SD
	<b>C02</b>	CX-1030-SD
	<b>C03</b>	CX-1050-SD
	<b>C04</b>	CX-1070-SD
	<b>C05</b>	CX-1080-SD
<b>Calibrated</b>	<b>C07</b>	CX-1010-SD-0.1L
	<b>C16</b>	CX-1030-SD-0.3L
	<b>C25</b>	CX-1050-SD-1.4L
	<b>C31</b>	CX-1070-SD-4L
	<b>C32</b>	CX-1080-SD-20L
	<b>C13</b>	CX-1010-SD-1.4L

### Platinum RTDs

<b>Uncalibrated</b>	<b>P01</b>	PT-102
	<b>P02</b>	PT-103
	<b>P03</b>	PT-111
<b>Calibrated</b>	<b>P04</b>	PT-102-2S
	<b>P05</b>	PT-102-3S
	<b>P07</b>	PT-102-14L
	<b>P08</b>	PT-102-14H
	<b>P11</b>	PT-103-2S
	<b>P12</b>	PT-103-3S
	<b>P14</b>	PT-103-14L
	<b>P15</b>	PT-103-14H
	<b>P18</b>	PT-111-2S
	<b>P19</b>	PT-111-3S
	<b>P21</b>	PT-111-14L
	<b>P22</b>	PT-111-14H

### Silicon diodes

<b>Uncalibrated</b>	<b>S07</b>	DT-670A-SD
	<b>S08</b>	DT-670B-SD
	<b>S09</b>	DT-670C-SD
	<b>S10</b>	DT-670D-SD
	<b>S0A</b>	DT-670A1-SD
	<b>S0B</b>	DT-670B1-SD
	<b>Calibrated</b>	<b>S27</b>
<b>S28</b>		DT-670-SD-1.4H
<b>S32</b>		DT-670-SD-70L
<b>S33</b>		DT-670-SD-70H



## Cernox® RTDs

### Cernox® features

- Low magnetic field-induced errors
- Temperature range of 100 mK to 420 K (model dependent)
- High sensitivity at low temperatures and good sensitivity over a broad range
- Excellent resistance to ionizing radiation
- Bare die sensor with fast characteristic thermal response times: 1.5 ms at 4.2 K, 50 ms at 77 K
- Broad selection of models to meet your thermometry needs
- Excellent stability
- Variety of packaging options



**CAUTION:** These sensors are sensitive to electrostatic discharge (ESD). Use ESD precautionary procedures when handling, or making mechanical or electrical connections to these devices in order to avoid performance degradation or loss of functionality.

Cernox® thin film resistance temperature sensors offer significant advantages over comparable bulk or thick film resistance sensors. The smaller package size of these thin film sensors makes them useful in a broader range of experimental mounting schemes, and they are also available in a chip form. They are easily mounted in packages designed for excellent heat transfer, yielding a characteristic thermal response time much faster than possible with bulk devices requiring strain-free mounting. Additionally, they have been proven very stable over repeated thermal cycling and under extended exposure to ionizing radiation.

CX-SD

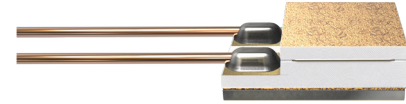

CX-BR

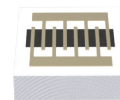

### Packaging options

AA, BC, BG, BO, BR, CD,  
CO, CU, ET, LR, MT, SD

### CX-1010—the ideal replacement for germanium RTDs

The CX-1010 is the first Cernox® designed to operate down to 100 mK, making it an ideal replacement for Germanium RTDs. Unlike Germanium, all Cernox models have the added advantage of being able to be used to room temperature. In addition, Cernox is offered in the incredibly robust Lake Shore SD package, giving researchers more flexibility in sensor mounting.

### The Lake Shore SD package — the most rugged, versatile package in the industry

The SD package, with direct sensor-to-sapphire base mounting, hermetic seal, and brazed Kovar leads, provides the industry's most rugged, versatile sensors with the best sample to chip connection. Designed so heat coming down the leads bypasses the chip, it can survive several thousand hours at 500 K (depending on model) and is compatible with most ultra high vacuum applications. It can be indium soldered to samples without shift in sensor calibration. If desired, the SD package is also available without Kovar leads.

### Typical Cernox® resistance

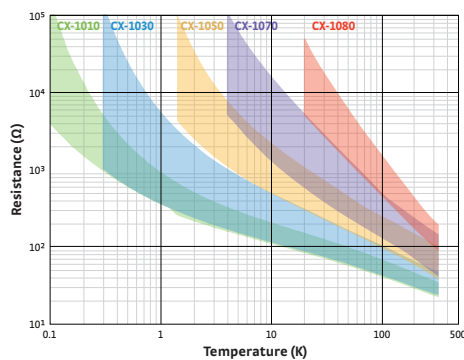

### Typical Cernox® sensitivity

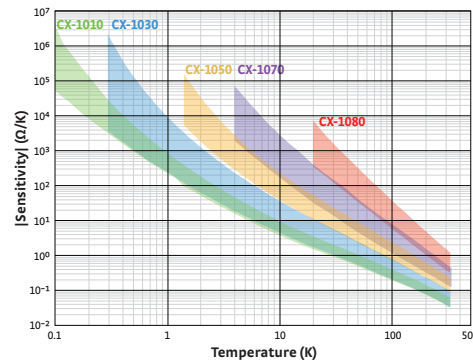

### Typical Cernox® dimensionless sensitivity

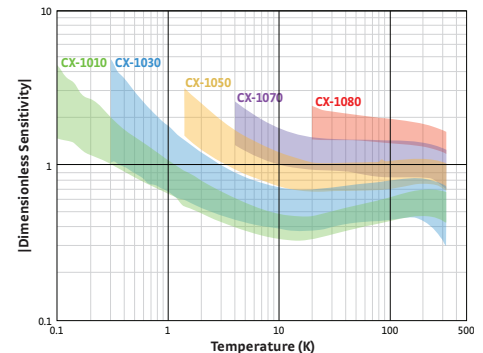





## Specifications

**Standard curve** Not applicable

**Recommended excitation**<sup>1</sup> 20  $\mu\text{V}$  (0.1 K to 0.5 K); 63  $\mu\text{V}$  (0.5 K to 1 K); 10 mV or less for  $T > 1.2$  K

**Dissipation at recommended excitation** Typical  $10^{-5}$  W at 300 K,  $10^{-7}$  W at 4.2 K,  $10^{-13}$  W at 0.3 K (model and temperature dependent)

**Thermal response time** BC, BR, BG: 1.5 ms at 4.2 K, 50 ms at 77 K, 135 ms at 273 K; SD: 15 ms at 4.2 K, 0.25 s at 77 K, 0.8 s at 273 K; AA: 0.4 s at 4.2 K, 2 s at 77 K, 1.0 s at 273 K

**Use in radiation** Recommended for use in radiation environments—see Appendix B

**Use in magnetic field** Recommended for use in magnetic fields at low temperatures. The magnetoresistance is typically negligibly small above 30 K and not significantly affected by orientation relative to the magnetic field—see Appendix B

**Reproducibility**<sup>2</sup>  $\pm 3$  mK at 4.2 K

**Soldering standard** J-STD-001 Class 2

<sup>1</sup> Recommended excitation for  $T < 1$  K based on Lake Shore calibration procedures using an AC resistance bridge—for more information refer to Appendix D and Appendix E

<sup>2</sup> Short-term reproducibility data is obtained by subjecting sensor to repeated thermal shocks from 305 K to 4.2 K

## Range of use

	Minimum limit	Maximum limit
Cernox®	0.10 K <sup>3</sup>	420 K

<sup>3</sup> Model dependent

## Calibrated accuracy<sup>4</sup>

	Typical sensor accuracy <sup>5</sup>	Long-term stability <sup>6</sup>
1.4 K	$\pm 5$ mK	$\pm 3$ mK
4.2 K	$\pm 5$ mK	$\pm 3$ mK
10 K	$\pm 6$ mK	$\pm 6$ mK
20 K	$\pm 9$ mK	$\pm 12$ mK
30 K	$\pm 10$ mK	$\pm 18$ mK
50 K	$\pm 13$ mK	$\pm 30$ mK
77 K	$\pm 16$ mK	$\pm 46$ mK
300 K	$\pm 60$ mK	$\pm 180$ mK
400 K	$\pm 65$ mK	—

<sup>4</sup> Bare chip sensors can only be calibrated after attaching gold wire leads—the user must remove the ball bonded leads if they are not desired (the bond pads are large enough for additional bonds)

<sup>5</sup>  $[(\text{Calibration uncertainty})^2 + (\text{reproducibility})^2]^{0.5}$  for more information see Appendices B, D, and E

<sup>6</sup> Long-term stability data is obtained by subjecting sensor to 200 thermal shocks from 305 K to 77 K

## Typical magnetic field-dependent temperature errors<sup>7</sup> $\Delta T/T$ (%) at B (magnetic induction)

	Cernox® 1050			
	2.5 T	8 T	14 T	19 T
2 K	1.3	3.1	3.9	5
4.2 K	0.1	-0.15	-0.85	-0.8
10 K	0.04	-0.4	-1.1	-1.5
20 K	0.04	0.02	-0.16	-0.2
30 K	0.01	0.04	0.06	0.11
77 K	0.002	0.022	0.062	0.11
300 K	0.003	0.004	0.004	0.006

<sup>7</sup> Excellent for use in magnetic fields, depending on temperature range ( $> 2$  K)

## Temperature response data table (typical)

	CX-1010			CX-1030			CX-1050			CX-1070			CX-1080		
	R <sup>8</sup> ( $\Omega$ )	dR/dT ( $\Omega/\text{K}$ )	(T/R)·(dR/dT)	R <sup>8</sup> ( $\Omega$ )	dR/dT ( $\Omega/\text{K}$ )	(T/R)·(dR/dT)	R <sup>8</sup> ( $\Omega$ )	dR/dT ( $\Omega/\text{K}$ )	(T/R)·(dR/dT)	R <sup>8</sup> ( $\Omega$ )	dR/dT ( $\Omega/\text{K}$ )	(T/R)·(dR/dT)	R <sup>8</sup> ( $\Omega$ )	dR/dT ( $\Omega/\text{K}$ )	(T/R)·(dR/dT)
4.2	277.32	-32.209	-0.49	574.20	-97.344	-0.71	3507.2	-1120.8	-1.34	5979.4	-2225.3	-1.56	—	—	—
10	187.11	-8.063	-0.43	331.67	-19.042	-0.57	1313.5	-128.58	-0.98	1927.2	-214.11	-1.11	—	—	—
20	138.79	-3.057	-0.44	225.19	-6.258	-0.56	692.81	-30.871	-0.89	938.93	-46.553	-0.99	6157.5	-480.08	-1.56
30	115.38	-1.819	-0.47	179.12	-3.453	-0.58	482.88	-14.373	-0.89	629.90	-20.613	-0.98	3319.7	-165.61	-1.50
77.35	70.837	-0.510	-0.56	101.16	-0.820	-0.63	205.67	-2.412	-0.91	248.66	-3.150	-0.98	836.52	-15.398	-1.42
300	30.392	-0.065	-0.65	41.420	-0.088	-0.64	59.467	-0.173	-0.87	66.441	-0.201	-0.91	129.39	-0.545	-1.26
400 (HT)	—	—	—	34.779	-0.050	-0.57	46.782	-0.093	-0.79	51.815	-0.106	-0.81	91.463	-0.261	-1.14
420 (HT)	—	—	—	33.839	-0.045	-0.55	45.030	-0.089	-0.77	49.819	-0.094	-0.80	86.550	-0.231	-1.12

<sup>7</sup> See Appendix G for expanded response table

<sup>8</sup> Cernox sensors do not follow a standard response curve — the listed resistance ranges are typical, but can vary widely; consult Lake Shore to choose a specific range

**Magnetic field dependence data for sample CX RTDs**

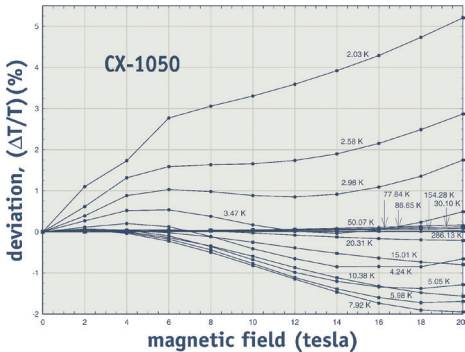

Typical temperature reading errors for operation of CX-1050 sensors in magnetic fields at temperatures from 2.03 K to 286 K. "Low temperature thermometry in high magnetic fields VII. Cernox® sensors to 32 T," B. L. Brandt, D. W. Liu and L. G. Rubin; Rev. Sci. Instrum., Vol. 70, No. 1, 1999, pp 104-110.

**Neutrons and gamma rays**

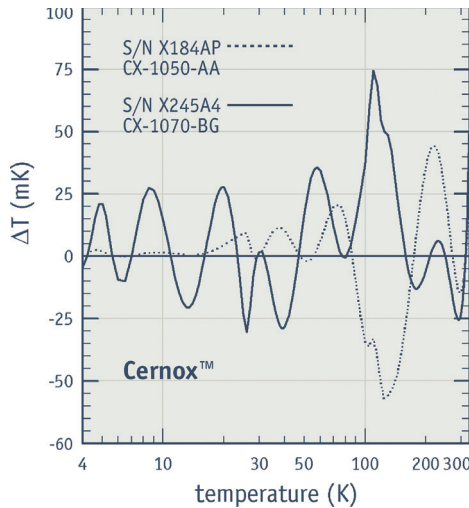

**Typical calibration shifts**

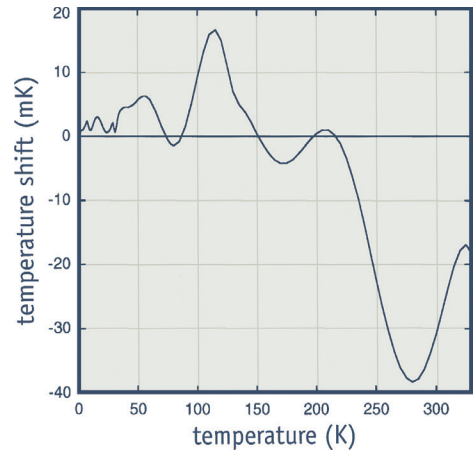

Typical calibration shift after 200 thermal shocks from 305 K to 77 K for a Model CX-1030 temperature sensor ( $\Delta T = 1$  mK at 4.2 K and 10 mK at 100 K).

**CX-BR**

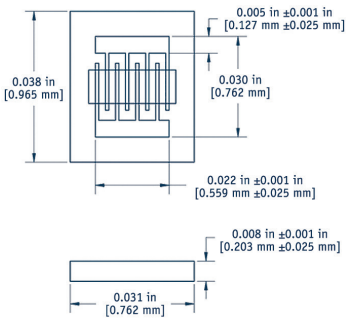

General tolerance of  $\pm 0.002$  in [ $\pm 0.051$  mm] unless otherwise noted

**CX-SD**

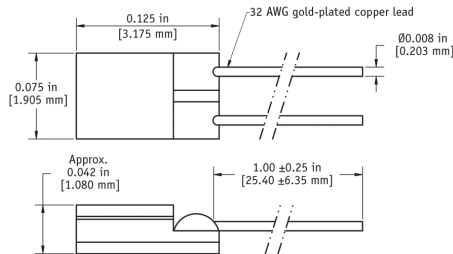

General tolerance of  $\pm 0.005$  in [ $\pm 0.127$  mm] unless otherwise noted

**CX-AA**

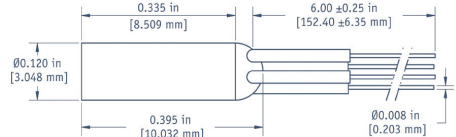

General tolerance of  $\pm 0.005$  in [ $\pm 0.127$  mm] unless otherwise noted

**Physical specifications**

	Mass	Lead type	Internal atmosphere
Bare chip (BC), (BG), (BR)	$\leq 3.0$ mg	BR: none BG: two 2 mil (44 AWG) bare gold 25 mm long wires BC: two 2.5 mil (42 AWG) bare copper 25 mm long wires	NA
Hermetic ceramic package (SD)	$\approx 40$ mg	2 gold-plated copper	Vacuum
Copper canister package (AA)	$\approx 390$ mg	4 phosphor bronze with HML heavy build insulation attached with epoxy strain relief at sensor	Helium 4 ("He) is standard

**AA package**

Wires with the same color code are connected to the same side of the sensor (looking at epoxy seal with leads toward user)

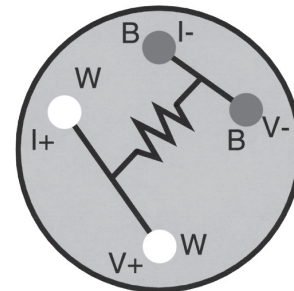

## Ordering information

**Uncalibrated sensor**—Specify the model number in the left column only, for example CX-1050-CD.

**Calibrated sensor**—Add the calibration range suffix code to the end of the model number, for example CX-1050-CD-1.4L.



Cernox® RTD	Calibration range suffix codes										
	Numeric figure is the low end of the calibration Letters represent the high end: L=325 K, M=420 K										
	Uncal	0.1L	0.1M	0.3L	0.3M	1.4L	1.4M	4L	4M	20L	20M
CX-1010-AA, -BC, -BO, -CD, -ET, -LR, -MT	■	■				■					
CX-1010-BG-HT, -BR-HT	■					■	■				
CX-1010-CO-HT, -CU-HT, -SD-HT	■	■	■			■	■				
CX-1030-AA, -BC, -BO, -CD, -ET, -LR, -MT	■			■		■					
CX-1030-BG-HT, -BR-HT	■					■					
CX-1030-CO-HT, -CU-HT, -SD-HT	■			■	■	■	■				
CX-1050-AA, -BC, -BO, -CD, -ET, -LR, -MT	■					■					
CX-1050-BG-HT, -BR-HT	■					■					
CX-1050-CO-HT, -CU-HT, -SD-HT	■					■	■				
CX-1070-AA, -BC, -BO, -CD, -ET, -LR, -MT	■							■			
CX-1070-BG-HT, -BR-HT	■										
CX-1070-CO-HT, -CU-HT, -SD-HT	■							■	■		
CX-1080-AA, -BC, -BO, -CD, -ET, -LR, -MT	■									■	
CX-1080-BG-HT, -BR-HT	■										
CX-1080-CO-HT, -CU-HT, -SD-HT	■									■	■

**ADD -P** Add spot-welded platinum leads to the SD package for Cernox® sensors only

### Accessories available for sensors

- SN-CO-C1 SD package sensor clamp, qty 1
- SN-CO-C10 SD package sensor clamp, qty 10
- 8000-CD Calibration report on CD-ROM
- 8000-USB Calibration report on USB
- COC-SEN Certificate of conformance

### Accessories suggested for installation—

- see **Accessories section for full descriptions**
- Stycast® epoxy
  - Apiezon® grease
  - 90% Pb, 10% Sn solder
  - Indium solder
  - VGE-7031 varnish
  - Phosphor bronze wire
  - Manganin wire
  - CryoCable™

## Packaging options

For more information on sensor packages and mounting adapters, see page 20.

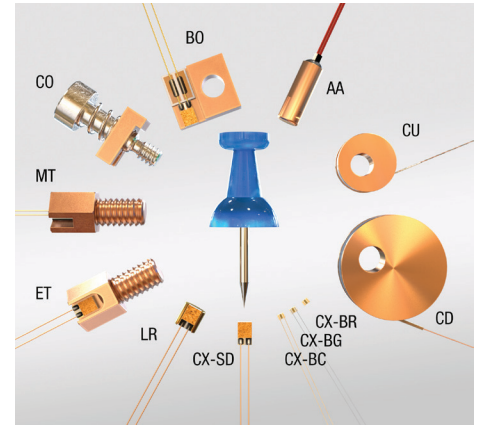

**CO adapter** — spring loaded clamp for easy sensor interchangeability



See the appendices for a detailed description of:

- Installation
- Uncalibrated sensors
- SoftCal™
- Calibrated sensors
- CalCurve™
- Sensor packages

To add length to sensor leads, see page 25.



## DT-670 Silicon Diodes

### DT-670-SD features

- Best accuracy across the widest useful temperature range—1.4 K to 500 K—of any silicon diode in the industry
- Tightest tolerances for 30 K to 500 K applications of any silicon diode to date
- Rugged, reliable Lake Shore SD package designed to withstand repeated thermal cycling and minimize sensor self-heating
- Conformance to standard DT-670 temperature response curve
- Variety of packaging options

### DT-670E-BR features

- Temperature range: 1.4 K to 500 K
- Bare die sensors with the smallest size and fastest thermal response time of any silicon diode on the market today
- Non-magnetic sensor

### DT-621-HR features

- Temperature range: 1.4 K to 325 K (uncalibrated down to 20 K)
- Non-magnetic package
- Exposed flat substrate for surface mounting

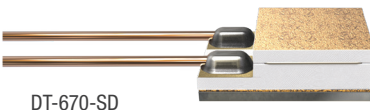

DT-670 Series silicon diodes offer better accuracy over a wider temperature range than any previously marketed silicon diodes. Conforming to the Curve DT-670 standard voltage versus temperature response curve, sensors within the DT-670 series are interchangeable, and for many applications do not require individual calibration. DT-670 sensors in the SD package are available in four tolerance bands—three for general cryogenic use across the 1.4 K to 500 K temperature range, and one that offers superior accuracy for applications from 30 K to room temperature.

DT-670-SD diodes are available with calibration across the full 1.4 K to 500 K temperature range.

The bare die sensor, the DT-670E-BR, provides the smallest physical size and fastest thermal response time of any silicon diode on the market today. This is an important advantage for applications where size and thermal response time are critical, including focal plane arrays and high temperature superconducting filters for cellular communication.

### Packaging options

**BO, BR, CO, CU, CY, DI, ET, LR, MT**



**CAUTION:** These sensors are sensitive to electrostatic discharge (ESD). Use ESD precautionary procedures when handling, or making mechanical or electrical connections to these devices in order to avoid performance degradation or loss of functionality.

### The Lake Shore SD package — the most rugged, versatile package in the industry

The SD package, with direct sensor-to-sapphire base mounting, hermetic seal, and brazed Kovar leads, provides the industry's most rugged, versatile sensors with the best sample to chip connection. Designed so heat coming down the leads bypasses the chip, it can survive several thousand hours at 500 K (depending on model) and is compatible with most ultra high vacuum applications. It can be indium soldered to samples without shift in sensor calibration. If desired, the SD package is also available without Kovar leads.

### Typical DT-670 diode voltage

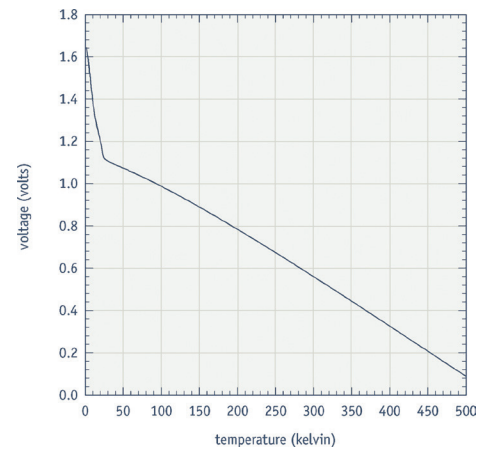

### Typical DT-670 diode sensitivity

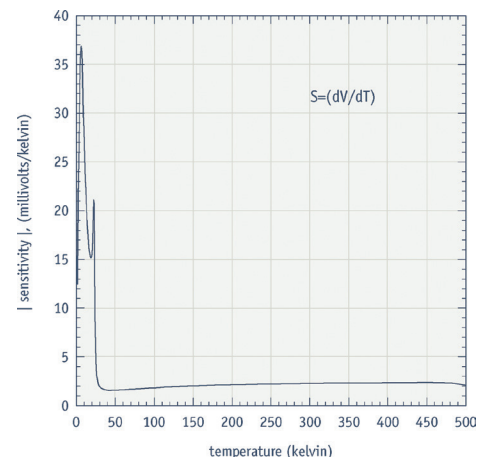



## Specifications

**Standard curve** Curve DT-670—see next page

**Recommended excitation** 10  $\mu$ A  $\pm$ 0.1%

**Max reverse voltage** 40 V

**Max current before damage** 1 mA continuous or 100 mA pulsed

**Dissipation at recommended excitation**

16  $\mu$ W at 4.2 K; 10  $\mu$ W at 77 K; 5  $\mu$ W at 300 K

**Thermal response time** SD: typical <10 ms at 4.2 K, 100 ms at 77 K, 200 ms at 305 K; BR: 1 ms at 4.2 K, 13 ms at 77 K, 20 ms at 305 K

**Use in radiation** Recommended for use only in low level radiation—see Appendix B

**Use in magnetic field** Not recommended for use in magnetic field applications below 60 K. Low magnetic field dependence when used in fields up to 5 tesla above 60 K—see Appendix B

**Reproducibility**<sup>1</sup>  $\pm$ 10 mK at 4.2 K

**Soldering standard** J-STD-001 Class 2

<sup>1</sup> Short-term reproducibility data is obtained by subjecting sensor to repeated thermal shocks from 305 K to 4.2 K

## Range of use

Package	Minimum limit	Maximum limit
SD, CU-HT, BR	1.4 K	500 K
CU, LR, CY, ET, MT, BO, HR	1.4 K	420 K

## DT-621-HR miniature silicon diode

The DT-621 miniature silicon diode temperature sensor is configured for installation on flat surfaces. Due to the absence of magnetic materials in its construction, this package is suited for applications where minimal interaction between the diode and sample space magnetic field is desired. The DT-621 sensor package exhibits precise, monotonic temperature response over its useful range. The sensor chip is in direct contact with the epoxy dome, which causes increased voltage below 20 K and prevents full range Curve DT-670 conformity. For use below 20 K, calibration is required.

DT-621-HR



## Calibrated accuracy

Typical sensor accuracy <sup>2</sup>	
1.4 K	$\pm$ 12 mK
4.2 K	$\pm$ 12 mK
10 K	$\pm$ 12 mK
77 K	$\pm$ 22 mK
300 K	$\pm$ 32 mK
500 K	$\pm$ 50 mK

<sup>2</sup> [(Calibration uncertainty)<sup>2</sup> +(reproducibility)<sup>2</sup>]<sup>0.5</sup> for more information see Appendices B, D, and E

## Temperature response data table (typical)

	DT-670		DT-621-HR	
	V (volts)	dV/dT (mV/K)	V (volts)	dV/dT (mV/K)
1.4 K	1.64	-12.5	—	—
4.2 K	1.58	-31.6	1.678	-35
10 K	1.38	-26.8	—	—
77 K	1.03	-1.73	1.03	1.73
305 K	0.560	-2.30	0.560	-2.3

See Appendix G for expanded response table

## Long-term stability

	Use to 305 K <sup>3</sup>	Use to 500 K <sup>4</sup>
4.2 K	$\pm$ 10 mK	$\pm$ 40 mK
77 K	$\pm$ 40 mK	$\pm$ 100 mK
305 K	$\pm$ 25 mK	$\pm$ 50 mK
500 K	—	$\pm$ 150 mK

<sup>3</sup> Long-term stability data is obtained by subjecting sensor to 200 thermal shocks from 305 K to 77 K

<sup>4</sup> Based on 670 h of baking at 500 K

## Standard curve DT-670 tolerance bands

	2 K to 100 K	100 K to 305 K	305 K to 500 K
Band A	$\pm$ 0.25 K	$\pm$ 0.5 K	$\pm$ 0.5 K
Band A1	$\pm$ 0.25 K	$\pm$ 1.5% of temp	$\pm$ 1.5% of temp
Band B	$\pm$ 0.5 K	$\pm$ 0.5 K	$\pm$ 0.33% of temp
Band B1	$\pm$ 0.5 K	$\pm$ 1.5% of temp	$\pm$ 1.5% of temp
Band C	$\pm$ 1 K	$\pm$ 1 K	$\pm$ 0.50% of temp

	30 K to 100 K	100 K to 305 K	305 K to 500 K
Band D <sup>5</sup>	$\pm$ 0.25 K	$\pm$ 0.50 K	$\pm$ 0.20% of temp

<sup>5</sup> For T < 30 K  $\pm$ 1.5 K

	2 K to 100 K	100 K to 500 K
DT-670E-BR	$\pm$ 1.5 K typical	$\pm$ 1.5% of temp typical

20 K to 325 K	
DT-621-HR	$\pm$ 2.5 K or $\pm$ 1.5% of temperature, whichever is greater

## Physical specifications

	Mass	Lead type	Lead polarity
DT-670-SD	37 mg	2—nickel and gold-plated Kovar	Positive lead on right with package lid up and leads towards user
DT-670E-BR (bare die)	72.7 $\mu$ g	None	Positive connection made through bottom of chip; negative connection made on base pad on top of chip
DT-621-HR	23 mg	2—platinum ribbon with tinned 60/40 SnPb solder	Positive lead is right-hand ribbon with platinum disk down and leads towards user

**Typical magnetic field-dependent temperature errors<sup>6</sup>  $\Delta T/T$  (%) at B (magnetic induction)**

Package base parallel to field B					
	1 T	2 T	3 T	4 T	5 T
4.2 K	-200	-300	-350	-400	-500
20 K	-10	-20	-25	-30	-40
40 K	-4	-6	-8	-10	-12
60 K	-0.5	-1	-2	-3	-3.5
80 K	< 0.1	-0.5	-0.8	-1.1	-1.5
300 K	<-0.1	<-0.1	<-0.1	<-0.1	<-0.1

Package base perpendicular to field B					
	1 T	2 T	3 T	4 T	5 T
4.2 K	-8	-9	-11	-15	-20
20 K	-4	-5	-5	-5	-10
40 K	-1.5	-3	-4	-5	-5.5
60 K	-0.5	-0.7	-0.8	-1	-1.1
80 K	-0.1	-0.3	-0.5	-0.6	-0.7
300 K	<0.1	0.2	0.5	0.6	0.6

<sup>6</sup> To minimize magnetic field-induced temperature errors, the sensor should be oriented so that the package base is perpendicular to the magnetic field flux lines—this results in the diode current being parallel to the magnetic field

**DT-670-SD**

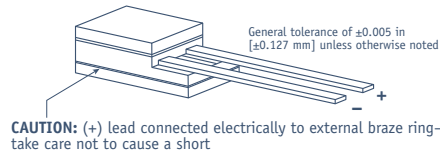
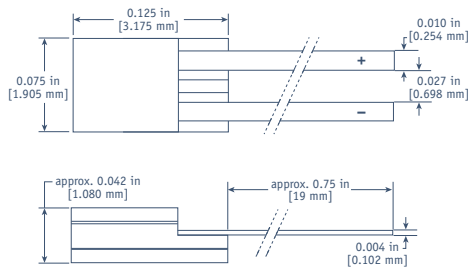

**DT-670E-BR**

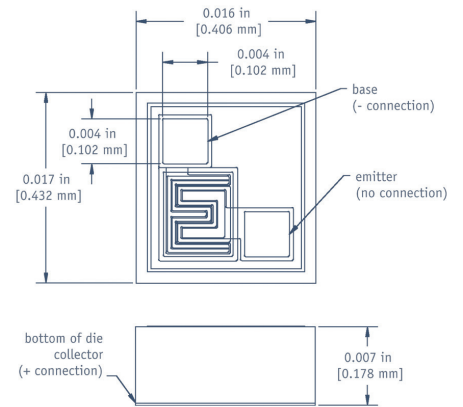

**DT-621-HR**

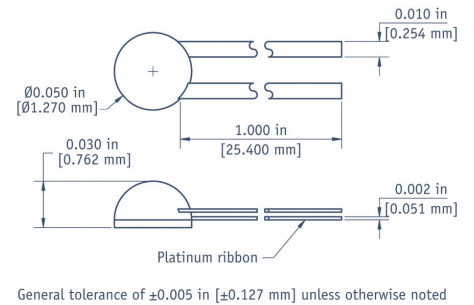

**DT-670 temperature response curve**

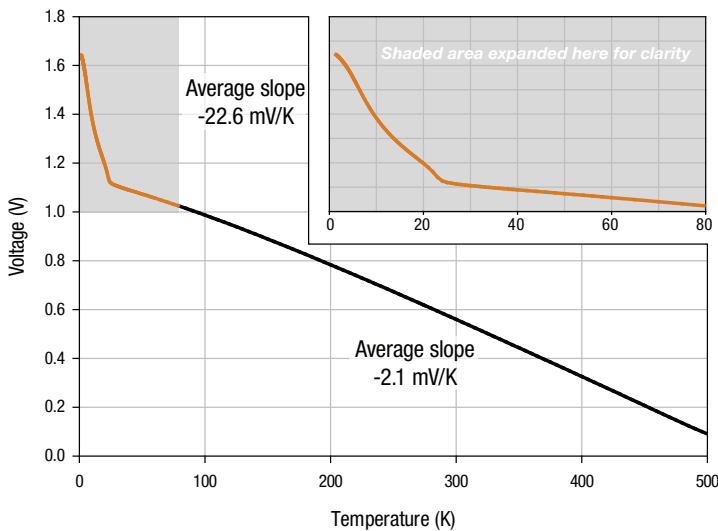

**Curve DT-670 tolerance bands**

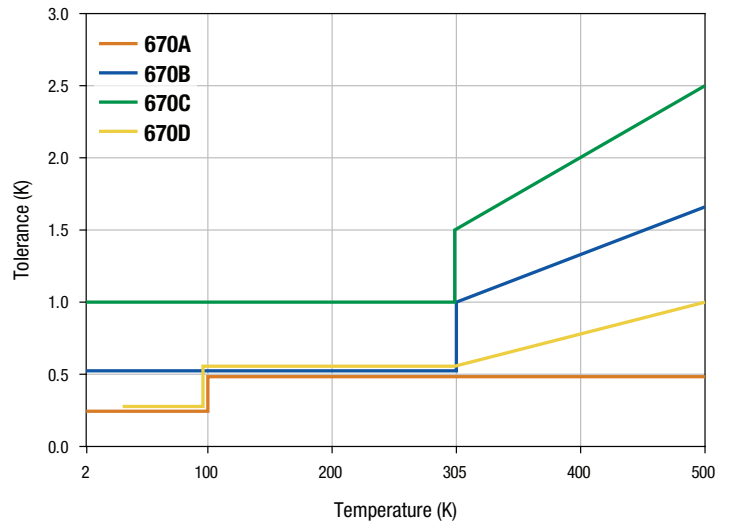



## DT-670 Series expanded temperature response data table

T (K)	Voltage (V)	dV/dT (mV/K)	T (K)	Voltage (V)	dV/dT (mV/K)	T (K)	Voltage (V)	dV/dT (mV/K)	T (K)	Voltage (V)	dV/dT (mV/K)
1.4	1.644290	-12.5	6.0	1.51541	-36.7	28.0	1.110421	-2.25	160.0	0.868518	-2.07
1.5	1.642990	-13.6	6.5	1.49698	-36.9	29.0	1.108261	-2.08	170.0	0.847659	-2.10
1.6	1.641570	-14.8	7.0	1.47868	-36.2	30.0	1.106244	-1.96	180.0	0.826560	-2.12
1.7	1.640030	-16.0	7.5	1.46086	-35.0	31.0	1.104324	-1.88	190.0	0.805242	-2.14
1.8	1.638370	-17.1	8.0	1.44374	-33.4	32.0	1.102476	-1.82	200.0	0.783720	-2.16
1.9	1.636600	-18.3	8.5	1.42747	-31.7	33.0	1.100681	-1.77	210.0	0.762007	-2.18
2.0	1.634720	-19.3	9.0	1.41207	-29.9	34.0	1.098930	-1.73	220.0	0.740115	-2.20
2.1	1.632740	-20.3	9.5	1.39751	-28.3	35.0	1.097216	-1.70	230.0	0.718054	-2.21
2.2	1.630670	-21.1	10.0	1.38373	-26.8	36.0	1.095534	-1.69	240.0	0.695834	-2.23
2.3	1.628520	-21.9	10.5	1.37065	-25.5	37.0	1.093878	-1.64	250.0	0.673462	-2.24
2.4	1.626290	-22.6	11.0	1.35820	-24.3	38.0	1.092244	-1.62	260.0	0.650949	-2.26
2.5	1.624000	-23.2	11.5	1.34632	-23.2	39.0	1.090627	-1.61	270.0	0.628302	-2.27
2.6	1.621660	-23.6	12.0	1.33499	-22.1	40.0	1.089024	-1.60	273.0	0.621141	-2.28
2.7	1.619280	-24.0	12.5	1.32416	-21.2	42.0	1.085842	-1.59	280.0	0.605528	-2.28
2.8	1.616870	-24.2	13.0	1.31381	-20.3	44.0	1.082669	-1.59	290.0	0.582637	-2.29
2.9	1.614450	-24.4	13.5	1.30390	-19.4	46.0	1.079492	-1.59	300.0	0.559639	-2.30
3.0	1.612000	-24.7	14.0	1.29439	-18.6	48.0	1.076303	-1.60	310.0	0.536542	-2.31
3.1	1.609510	-25.1	14.5	1.28526	-17.9	50.0	1.073099	-1.61	320.0	0.513361	-2.32
3.2	1.606970	-25.6	15.0	1.27645	-17.3	52.0	1.069881	-1.61	330.0	0.490106	-2.33
3.3	1.604380	-26.2	15.5	1.26794	-16.8	54.0	1.066650	-1.62	340.0	0.466760	-2.34
3.4	1.601730	-26.8	16.0	1.25967	-16.3	56.0	1.063403	-1.63	350.0	0.443371	-2.34
3.5	1.599020	-27.4	16.5	1.25161	-15.9	58.0	1.060141	-1.64	360.0	0.419960	-2.34
3.6	1.596260	-27.9	17.0	1.24372	-15.6	60.0	1.056862	-1.64	370.0	0.396503	-2.35
3.7	1.59344	-28.4	17.5	1.23596	-15.4	65.0	1.048584	-1.67	380.0	0.373002	-2.35
3.8	1.59057	-29.0	18.0	1.22830	-15.3	70.0	1.040183	-1.69	390.0	0.349453	-2.36
3.9	1.58764	-29.6	18.5	1.22070	-15.2	75.0	1.031651	-1.72	400.0	0.325839	-2.36
4.0	1.58465	-30.2	19.0	1.21311	-15.2	77.35	1.027594	-1.73	410.0	0.302161	-2.37
4.2	1.57848	-31.6	19.5	1.20548	-15.3	80.0	1.022984	-1.75	420.0	0.278416	-2.38
4.4	1.57202	-32.9	20.0	1.197748	-15.6	85.0	1.014181	-1.77	430.0	0.254592	-2.39
4.6	1.56533	-34.0	21.0	1.181548	-17.0	90.0	1.005244	-1.80	440.0	0.230697	-2.39
4.8	1.55845	-34.7	22.0	1.162797	-21.1	100.0	0.986974	-1.85	450.0	0.206758	-2.39
5.0	1.55145	-35.2	23.0	1.140817	-20.8	110.0	0.968209	-1.90	460.0	0.182832	-2.39
5.2	1.54436	-35.6	24.0	1.125923	-9.42	120.0	0.949000	-1.94	470.0	0.159010	-2.37
5.4	1.53721	-35.9	25.0	1.119448	-4.60	130.0	0.929390	-1.98	480.0	0.135480	-2.33
5.6	1.53000	-36.2	26.0	1.115658	-3.19	140.0	0.909416	-2.01	490.0	0.112553	-2.25
5.8	1.52273	-36.5	27.0	1.112810	-2.58	150.0	0.889114	-2.05	500.0	0.090681	-2.12

## Ordering information

### Uncalibrated sensor

**Step 1:** Choose diode series, for example DT-670.

**Step 2:** Choose tolerance band (if applicable), for example DT-670A.

**Step 3:** Choose package or mounting adapter—if ordering adapter, substitute the adapter suffix for the SD suffix, for example DT-670A-CU.

### Calibrated sensor

**Step 1:** Choose diode series, for example DT-670.

**Step 2:** Choose package or mounting adapter—if ordering adapter, substitute the adapter suffix for the SD suffix, for example DT-670-CU.

**Step 3:** Specify the calibration range suffix code after the model number and package suffix, for example DT-670-CU-1.4L.

DT-670	Calibration range suffix codes				
	Numeric figure is the low end of the calibration Letters represent the high end: L=325 K, H=500 K				
Model number	Uncal	1.4L	1.4H	70L	70H
DT-621-HR	■	■		■	
DT-670A-SD	■				
DT-670A1-SD	■				
DT-670B-SD	■				
DT-670B1-SD	■				
DT-670C-SD	■				
DT-670D-SD	■				
DT-670-SD		■	■	■	■
Mounting adapters are available for use with the SD package— replace SD suffix with mounting adapter suffix					
CO	■	■	■	■	■
CU, LR, CY, ET, BO, MT	■	■		■	
CU-HT	■	■	■	■	■
DI	■				
DT-670E-BR-10	■	bare chip silicon diode sensor, quantity 10			

Note: upper temperature limit package dependent—see Sensor Packages section  
Other packaging available by special order—please consult Lake Shore

#### Accessories available for sensors

SN-CO-C1 SD package sensor clamp, qty 1  
SN-CO-C10 SD package sensor clamp, qty 10  
8000-CD Calibration report on CD-ROM  
8000-USB Calibration report on USB  
COC-SEN Certificate of conformance



#### Accessories suggested for installation—

see **Accessories** section for full descriptions  
Stycast® epoxy  
Apiezon® grease  
90% Pb, 10% Sn solder  
Indium solder  
VGE-7031 varnish  
Phosphor bronze wire  
Manganin wire

## Packaging options

For more information on sensor packages and mounting adapters, see page 20.

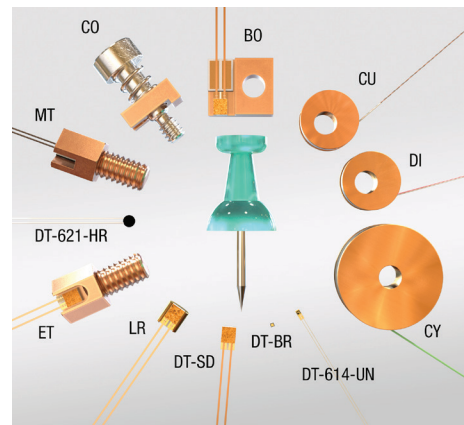

CO adapter —  
spring loaded  
clamp for  
easy sensor  
interchangeability

## Upgrade conversion chart

	From:	To:
Sensor	DT-470	DT-670
Band	11	A
	11A	A1
	12	B
	12A	B1
	13	C



See the appendices for a detailed description of:  
Installation  
Uncalibrated sensors  
SoftCal™  
Calibrated sensors  
CalCurve™  
Sensor packages

To add length to  
sensor leads,  
see page 25.



# Germanium RTDs

## Germanium features

- Recognized as a “Secondary Standard Thermometer”
- High sensitivity provides submillikelvin control at 4.2 K and below
- Excellent reproducibility better than  $\pm 0.5$  mK at 4.2 K
- Various models for use from 0.05 K to 100 K
- Excellent resistance to ionizing radiation

Lake Shore germanium resistance temperature sensors are recognized as “Secondary Standard Thermometers” and have been employed in the measurement of temperature from 0.05 K to 30 K for more than 40 years.

Germanium sensors have a useful temperature range of about two orders of magnitude. The exact range depends upon the doping of the germanium element. Sensors with ranges from below 0.05 K to 100 K are available. Between 100 K and 300 K,  $dR/dT$  changes sign and  $dR/dT$  above 100 K is very small for all models. Sensor resistance varies from several ohms at its upper useful temperature to several tens of kilohms at its lower temperature. Because device sensitivity increases rapidly with decreasing temperature, a high degree of resolution is achieved at lower temperatures, making these resistors very useful for submillikelvin control at 4.2 K and below.

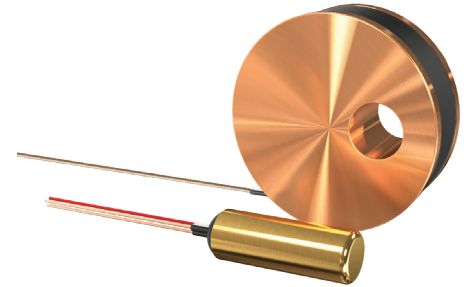

The sensors offer excellent stability, and  $\pm 0.5$  mK reproducibility at 4.2 K. The germanium resistor is usually the best choice for high-accuracy work below 30 K. Use in a magnetic field is not recommended.

## Packaging options

AA,CD

## Typical germanium resistance

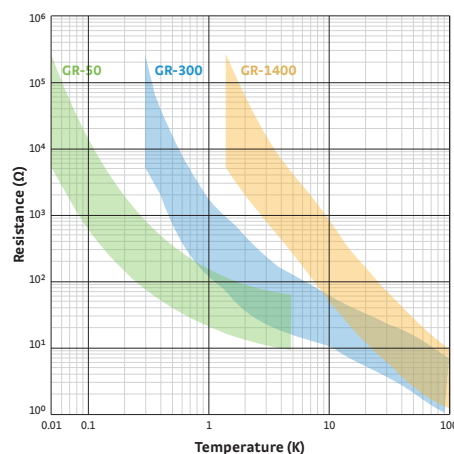

## Typical germanium sensitivity

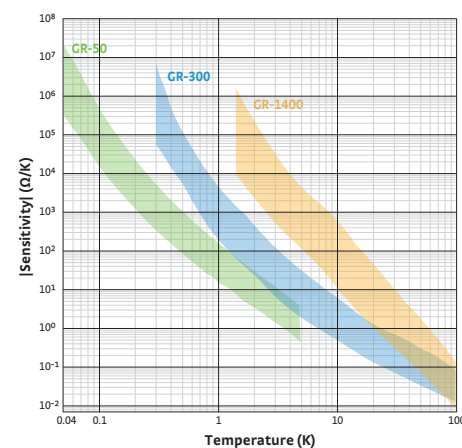

## Typical germanium dimensionless sensitivity

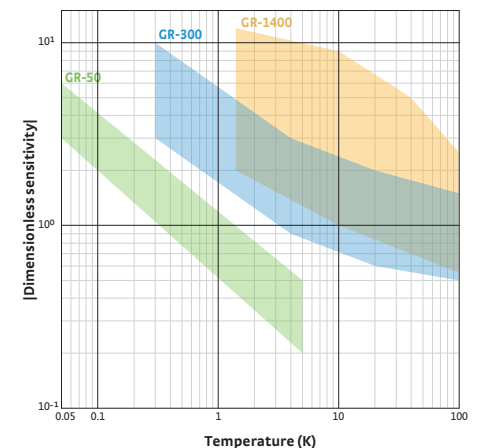

## Specifications

**Standard curve** Not applicable

**Recommended excitation**<sup>1</sup> 20  $\mu$ V (0.05 K to 0.1 K); 63  $\mu$ V (0.1 K to 1 K); 10 mV or less for  $T > 1$  K

**Dissipation at recommended excitation**  $10^{-13}$  W at 0.05 K,  $10^{-7}$  W at 4.2 K (temperature and model dependent)

**Thermal response time** 200 ms at 4.2 K, 3 s at 77 K

**Use in radiation** Recommended for use in ionizing radiation environments—see Appendix B

**Use in magnetic field** Because of their strong magnetoresistance and associated orientation effect, germanium sensors are of very limited use in magnetic fields—see Appendix B

**Soldering standard** J-STD-001 Class 2

## Reproducibility

	Short term <sup>2</sup>	Long term <sup>3</sup>
4.2 K	$\pm 0.5$ mK	$\pm 1$ mK/yr
77 K	—	$\pm 10$ mK/yr

<sup>1</sup> Recommended excitation for  $T < 1$  K based on Lake Shore calibration procedures using an AC resistance bridge—for more information refer to Appendix D and Appendix E

<sup>2</sup> Short-term reproducibility data is obtained by subjecting sensor to repeated thermal shocks from 305 K to 4.2 K

<sup>3</sup> Long-term stability data is obtained by subjecting sensor to 200 thermal shocks from 305 K to 77 K

## Range of use

	Minimum limit	Maximum limit
GR-50-AA	$< 0.05$ K	5 K
GR-300-AA	0.3 K	100 K
GR-1400-AA	1.4 K	100 K

## Calibrated accuracy<sup>4</sup>

	Typical sensor accuracy <sup>4</sup>		
	GR-50	GR-300	GR-1400
0.05 K	$\pm 5$ mK	—	—
0.3 K	$\pm 5$ mK	$\pm 4$ mK	—
0.5 K	$\pm 5$ mK	$\pm 4$ mK	—
1.4 K	$\pm 6$ mK	$\pm 4$ mK	$\pm 4$ mK
4.2 K	$\pm 6$ mK	$\pm 4$ mK	$\pm 4$ mK
77 K	—	$\pm 25$ mK	$\pm 15$ mK
100 K	—	$\pm 32$ mK	$\pm 18$ mK

<sup>4</sup>  $[(\text{Calibration uncertainty})^2 + (\text{reproducibility})^2]^{0.5}$  for more information see Appendices B, D, and E

## AA package

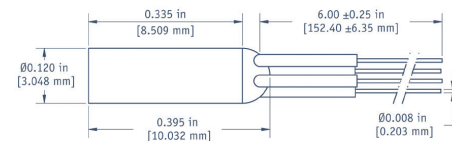

General tolerance of  $\pm 0.005$  in [ $\pm 0.127$  mm] unless otherwise noted

## Typical magnetic field-dependent temperature errors<sup>5</sup> $\Delta T/T$ (%) at B (magnetic induction)

	Germanium		
	2.5 T	8 T	14 T
2.0 K	-8	-60	—
4.2 K	-5 to -20	-30 to -55	-60 to -75
10 K	-4 to -15	-25 to -60	-60 to -75
20 K	-3 to -20	-15 to -35	-50 to -80

<sup>5</sup> Long axis of thermometer parallel to applied field

## Typical resistance values

GR-AA	Typical resistance at 4.2 K	Typical resistance range at 4.2 K
50	30 $\Omega$	9 $\Omega$ to 65 $\Omega$
300	95 $\Omega$	15 $\Omega$ to 155 $\Omega$
1400	1750 $\Omega$	350 $\Omega$ to 6500 $\Omega$

## Temperature response data table (typical)—see Appendix G for expanded response table

	GR-50-AA			GR-300-AA			GR-1400-AA		
	$R^{\circ}$ ( $\Omega$ )	$dR/dT$ ( $\Omega/K$ )	$(T/R) \cdot (dR/dT)$	$R^{\circ}$ ( $\Omega$ )	$dR/dT$ ( $\Omega/K$ )	$(T/R) \cdot (dR/dT)$	$R^{\circ}$ ( $\Omega$ )	$dR/dT$ ( $\Omega/K$ )	$(T/R) \cdot (dR/dT)$
0.05 K	35000	-3642000	-5.2	—	—	—	—	—	—
0.1 K	2320	-71860	-3.1	—	—	—	—	—	—
0.2 K	364.6	-4043	-2.2	—	—	—	—	—	—
0.3 K	164.0	-964.0	-1.8	35180	-512200	-4.4	—	—	—
0.5 K	73.75	-202.9	-1.4	5443	-34800	-3.2	—	—	—
1.0 K	33.55	-31.33	-0.93	875.7	-1901	-2.2	—	—	—
1.4 K	24.73	-13.15	-0.74	448.6	-581.3	-1.8	35890	-94790	-3.7
2.0 K	19.32	-6.167	-0.64	248.8	-187.4	-1.5	11040	-16670	-3.0
4.2 K	13.66	-1.036	-0.32	94.46	-26.56	-1.2	1689	-861.9	-2.1
10 K	—	—	—	33.20	-3.97	-1.2	252.8	-61.95	-2.5
40 K	—	—	—	7.79	-0.235	-1.2	9.57	-0.449	-1.9
77.4 K	—	—	—	3.50	-0.050	-1.1	3.55	-0.050	-1.1
100 K	—	—	—	2.72	-0.024	-0.88	2.80	-0.021	-0.74

### Proper selection of germanium sensors for use below 1 K

Germanium resistance thermometers are often classified according to their 4.2 K resistance value. However, for devices to be used below 1 K, there is no close correlation between the 4.2 K resistance and the suitability of the device as a thermometer. As a result, the Lake Shore low resistance germanium sensors (GR-50-AA and GR-300-AA) are classified according to their lowest useful temperatures, not their 4.2 K resistance values.

The resistance vs. temperature behavior for these devices is typical of all the germanium sensors. As the temperature is lowered, both the resistance and sensitivity ( $dR/dT$ ) increase logarithmically. The lowest useful temperature is generally limited by the rapidly increasing resistance and the difficulties encountered in measuring high resistance values.

The following recommendations are made concerning the optimum temperature range for using these devices:

GR-50-AA	0.05 K to 1.0 K
GR-300-AA	0.3 K to 100 K

Increasingly better temperature resolution is achievable at lower temperatures.

In general, it is recommended you do not purchase a device which has a lower temperature limit than required, since some sensitivity ( $dR/dT$ ) will be sacrificed at the higher temperatures. For example, a GR-300-AA will have more sensitivity at 1 K than a GR-50-AA.

### CD package

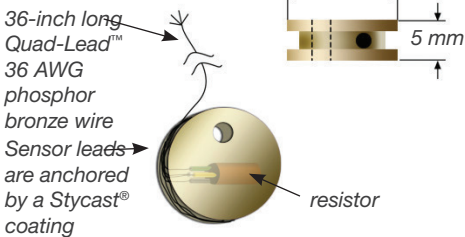

### Physical specifications

	Mass	Lead type	Internal atmosphere
GR-50-AA GR-300-AA GR-1400-AA	395 mg	4 color coded phosphor bronze with heavy build polyimide, attached with epoxy strain relief at sensor	Helium 4 (4He) at $\geq 500 \Omega$ , air at $< 500 \Omega$

### Germanium series construction detail

The epoxy holding the chip to the header is omitted for germanium devices designed for use below 1 K.

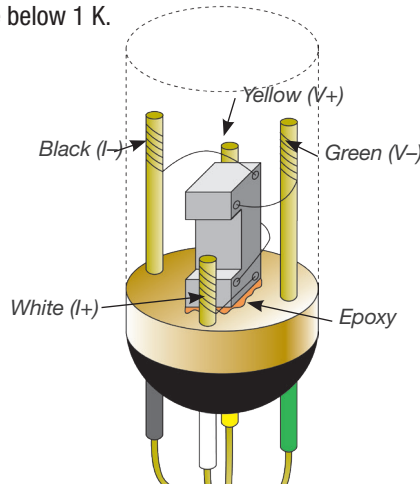

Looking at the wiring end with leads toward user

Key	Lead Color
W	I+ White
G	V- Green
Y	V+ Yellow
B	I- Black

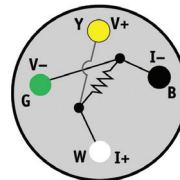

### Packaging options

For more information on sensor packages and mounting adapters, see page 20.

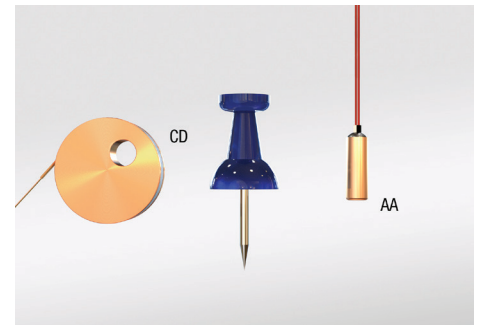

See the appendices for a detailed description of:  
 Installation  
 Uncalibrated sensors  
 SoftCal™  
 Calibrated sensors  
 CalCurve™  
 Sensor packages

To add length to sensor leads, see page 25.

### Ordering information

**Uncalibrated sensor**—Specify the model number in the left column only, for example GR-50-AA.

**Calibrated sensor**—Add the calibration range suffix code to the end of the model number, for example GR-50-AA-0.05A.

Germanium RTD	Calibration range suffix codes			
	Numeric figure is the low end of the calibration Letters represent the high end: A=5 K, D=100 K			
Part number	Uncal	0.05A	0.3D	1.4D
GR-50-AA	■	■		
GR-300-AA	■		■	■
GR-1400-AA	■			■
GR-50-CD	■	■		
GR-300-CD	■		■	■
GR-1400-CD	■			■

\*NOTE: The GR-50-AA calibration is not useful above 5 K  
 Other packaging available through special order—consult Lake Shore

**Accessories available for sensors**  
 COC-SEN Certificate of conformance





## Ultra-low temperature Rox™

### RX-102B-RS features

- Calibrated down to 5 mK
- Optical shielding reduces unwanted sensor heating

### Temperature measurement for the world's greatest dilution refrigerators

ULT Rox™ sensors are designed to achieve ultra-low temperatures down to 5 mK. These sensors are calibrated down to 5 mK and up to 40 K with guaranteed calibration accuracies. The package is optimized for thermalization and minimizes optical radiation absorption, thereby reducing heat load and temperature rise from line-of-sight radiation emitted by higher-temperature objects such as a cold plate or surrounding shields. The package is also designed to minimize environmental noise, which is critical for 5 mK measurements. This sensor pairs with the 372 temperature controller to monitor and control temperature below 50 mK.

### Packaging options

RS

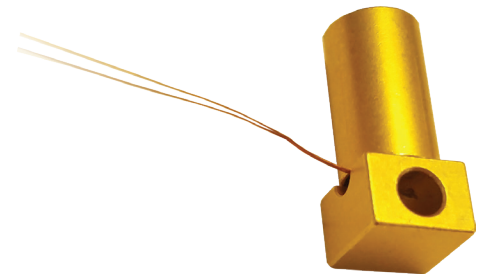

Typical resistance  $\Omega$

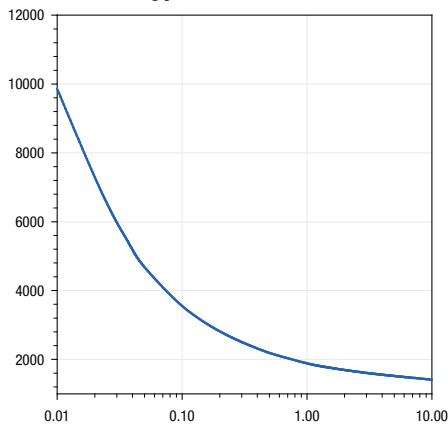

Typical sensitivity  $|\Omega/\text{mK}|$

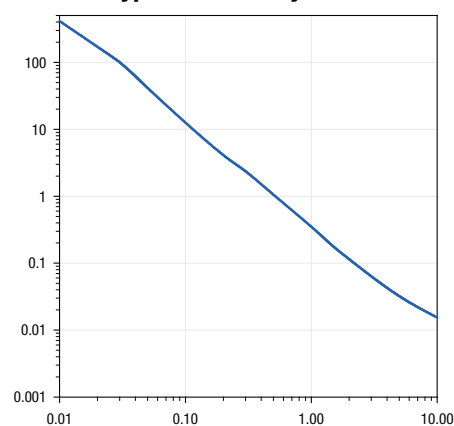

Typical dimensionless sensitivity  $|S_d|$

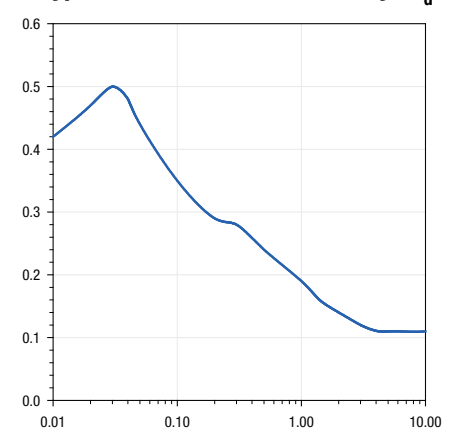



## Specifications

**Recommended excitation**<sup>1</sup> 20  $\mu$ V (0.05 K to 0.1 K); 63  $\mu$ V (0.1 K to 1.2 K); 10 mV or less for  $T > 1$  K

**Dissipation at recommended excitation**  $7.5 \times 10^{-8}$  W at 4.2 K

**Thermal response time** 0.5 s at 4.2 K, 2.5 s at 77 K

**Radiation effects** Recommended—see Appendix B

**Magnetic field** Not recommended

**Reproducibility**<sup>2</sup>  $\pm 15$  mK at 4.2 K

**Soldering standard** J-STD-001 Class 2

<sup>1</sup> Recommended excitation for  $T < 1$  K based on Lake Shore calibration procedures using an AC resistance bridge—for more information refer to Appendix D and Appendix E

<sup>2</sup> Short-term reproducibility data is obtained by subjecting sensor to repeated thermal shocks from 305 K to 4.2 K

## Range of use

	Minimum limit	Maximum limit
RX-102B-RS calibrated	0.005 K	40 K

## Calibrated accuracy<sup>3</sup>

	RX-102B-RS	RX-102B-CB (discontinued)
5 mK	$\pm 1.2$ mK <sup>4</sup>	—
7 mK	$\pm 0.8$ mK <sup>4</sup>	—
10 mK	$\pm 1$ mK	$\pm 1$ mK <sup>4</sup>
20 mK	$\pm 2$ mK	$\pm 2$ mK
50 mK	$\pm 4$ mK	$\pm 4$ mK
1.4 K	$\pm 16$ mK	$\pm 16$ mK
4.2 K	$\pm 16$ mK	$\pm 16$ mK
10 K	$\pm 30$ mK	$\pm 30$ mK

<sup>3</sup> [(Calibration uncertainty)<sup>2</sup> + (reproducibility)<sup>2</sup>]<sup>0.5</sup> for more information see Appendices B, D, and E

<sup>4</sup> Extrapolated accuracy values are anticipated

## Long-term stability

	RX-102B-RS	RX-102B-CB (discontinued)
4.2 K	$\pm 30$ mK	$\pm 30$ mK

## Typical magnetic field-dependent temperature errors $\Delta T/T$ (%) at B (magnetic induction)

	Rox™ 102B			
	2.5 T	8 T	14 T	19 T
2 K	3.29	13.82	22.53	27.95
3 K	3.96	14.68	23.12	29.12
4 K	3.53	13.92	22.57	28.20
8 K	1.53	7.53	13.50	17.86
16 K	0.27	2.14	4.66	6.58
23 K	0.06	0.79	2.01	3.11

## Magnetic field dependence data for sample Rox™ RTDs

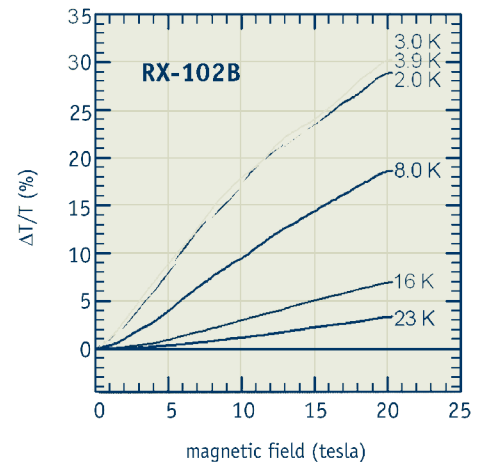

## Physical specifications

	Mass	Lead type	Mounting hole diameter
RX-102B-RS	5.36 g	Two 36 AWG copper leads with heavy build polyimide insulation, 15 cm length, lead ends tinned with 63/37 SnPb solder	Accommodates a #6-32 or M3 screw

## RX-102B-RS

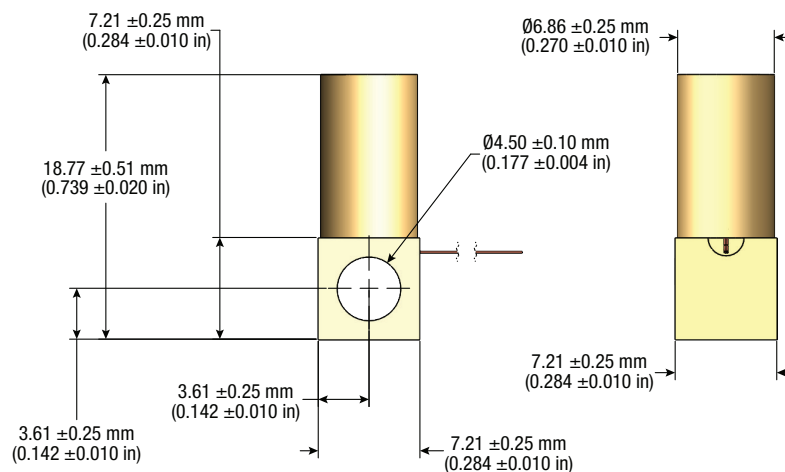



### Packaging options

For more information on sensor packages and mounting adapters, see page 20.

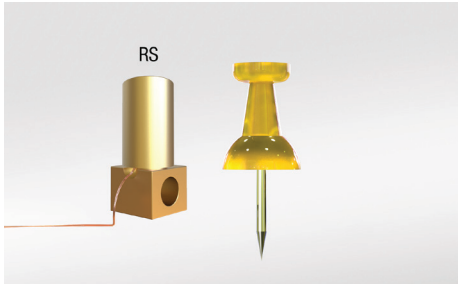

See the appendices for a detailed description of:

- Installation
- Uncalibrated sensors
- SoftCal™
- Calibrated sensors
- CalCurve™
- Sensor packages

To add length to sensor leads see page 25.

### Ordering information

ULT Rox™ RTD	Calibration range suffix codes Numeric figure is the low end of the calibration Letters represent the high end: C=1 K, B=40 K			
Part number	0.01B	0.01C	0.02B	0.02C
RX-102B-RS	■	■	■	■

*Note: the RX-102B-RS is not interchangeable to a standard curve and is not available as matched. Other packaging available through special order—consult Lake Shore*

#### Accessories available for sensors

8000-CD Calibration report on CD-ROM  
8000-USB Calibration report on USB  
COC-SEN Certificate of conformance



#### Accessories suggested for installation—

see **Accessories** section for full descriptions

- Stycast® epoxy
- Apiezon® grease
- 90% Pb, 10% Sn solder
- Indium solder
- VGE-7031 varnish
- Phosphor bronze wire
- Manganin wire



# Interchangeable Rox™

## RX-102A features

- Standard curve interchangeable
- Good radiation resistance
- Useful down to 50 mK
- Low magnetic field-induced errors

## RX-202A features

- Standard curve interchangeable
- Good radiation resistance
- Monotonic from 50 mK to 300 K
- 4× improvement in magnetic field-induced errors over other ruthenium oxides

## RX-103A features

- Standard curve interchangeable
- Good radiation resistance
- Best choice for interchangeability from 1.4 K to 40 K
- Low magnetic field-induced errors

Ruthenium oxide temperature sensors are thick-film resistors used in applications involving magnetic fields. These composite sensors consist of bismuth ruthenate, ruthenium oxides, binders, and other compounds that allow them to obtain the necessary temperature and resistance characteristics. Each interchangeable Lake Shore Rox™ model adheres to a single resistance versus temperature curve.

## RX-102A

The RX-102A (1000  $\Omega$  at room temperature) is useful down to 50 mK and has better interchangeability than the RX-202A as well as low magnetic field-induced errors below 1 K.

## RX-202A

The RX-202A (2000  $\Omega$  at room temperature) has a 4× improvement in magnetic field-induced errors over other commercially available ruthenium oxide temperature sensors with similar resistances and sensitivities. Most ruthenium oxide sensors have a maximum useful temperature limit well below room temperature, where the sensitivity changes from negative to positive. The RX-202A however, is designed to have a monotonic response from 0.05 K up to 300 K.

## RX-103A

The RX-103A (10,000  $\Omega$  at room temperature) has a unique resistance and temperature response curve combined with low magnetic field-induced errors, and is the best choice for interchangeability from 1.4 K to 40 K.

## Packaging options

### AA, BR



RX-AA

## Typical interchangeable Rox™ resistance

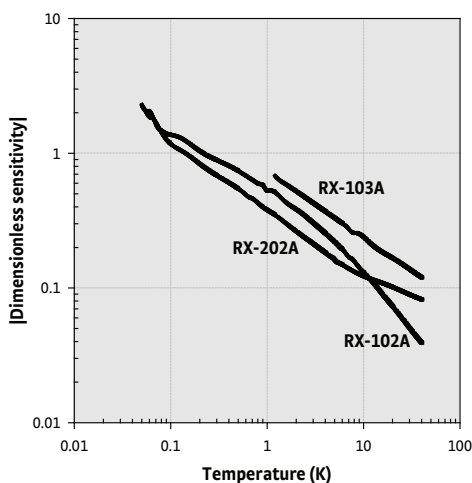

## Typical interchangeable Rox™ sensitivity

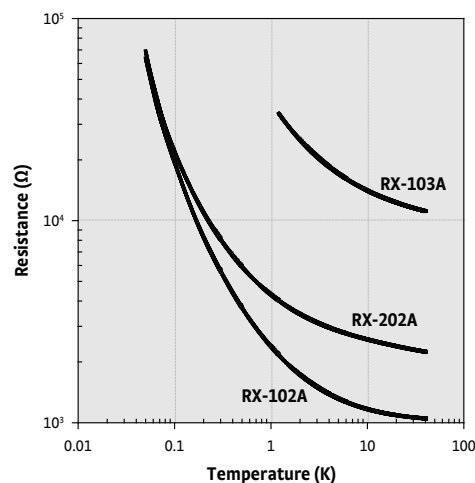

## Typical interchangeable Rox™ dimensionless sensitivity

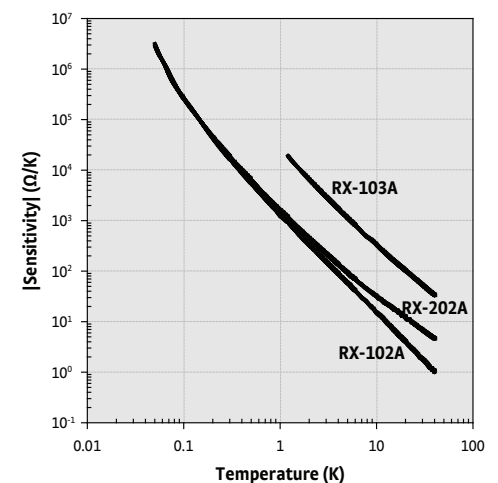



## Specifications

**Standard curve**<sup>1</sup> 102 and 202: 0.05 K to 40 K; 103: 1.4 K to 40 K

**Recommended excitation**<sup>2</sup> RX-102 and RX-202: 20  $\mu$ V (0.05 K to 0.1 K); 63  $\mu$ V (0.1 K to 1.2 K); 10 mV or less for  $T > 1$  K. RX-103: 10 mV or less for  $T > 1$  K

**Dissipation at recommended excitation** 102 and 202:  $7.5 \times 10^{-9}$  W at 4.2 K; 103:  $3.2 \times 10^{-9}$  W at 1.4 K,  $5.5 \times 10^{-9}$  W at 4.2 K,  $9.6 \times 10^{-9}$  W at 77 K

**Thermal response time** 0.5 s at 4.2 K, 2.5 s at 77 K

**Use in radiation** Recommended—see Appendix B

**Use in magnetic field**<sup>3</sup> Recommended—see Appendix B

**Reproducibility**<sup>4</sup>  $\pm 15$  mK

**Soldering standard** J-STD-001 Class 2

<sup>1</sup> 102B does not follow a standard curve

<sup>2</sup> Recommended excitation for  $T < 1$  K based on Lake Shore calibration procedures using an AC resistance bridge—for more information refer to Appendix D and Appendix E

<sup>3</sup> 102B not recommended for use in magnetic fields

<sup>4</sup> Short-term reproducibility data is obtained by subjecting sensor to repeated thermal shocks from 305 K to 4.2 K

## Accuracy: interchangeability

	RX-102A-AA-M matched	RX-102A-AA unmatched	RX-202A-AA-M matched	RX-202A-AA unmatched	RX-103A-AA-M matched	RX-103A-AA unmatched
0.05 K	$\pm 5$ mK	$\pm 10$ mK	$\pm 10$ mK	$\pm 15$ mK	—	—
0.3 K	$\pm 15$ mK	$\pm 20$ mK	$\pm 20$ mK	$\pm 25$ mK	—	—
0.5 K	$\pm 20$ mK	$\pm 25$ mK	$\pm 25$ mK	$\pm 30$ mK	—	—
1.4 K	$\pm 25$ mK	$\pm 50$ mK	$\pm 50$ mK	$\pm 100$ mK	$\pm 50$ mK	$\pm 150$ mK
4.2 K	$\pm 75$ mK	$\pm 125$ mK	$\pm 150$ mK	$\pm 250$ mK	$\pm 100$ mK	$\pm 400$ mK
20 K	$\pm 500$ mK	$\pm 1.25$ K	$\pm 1$ K	$\pm 2.5$ K	$\pm 700$ mK	$\pm 2$ K
40 K	$\pm 1.5$ K	$\pm 4$ K	$\pm 2$ K	$\pm 5$ K	$\pm 1.5$ K	$\pm 4$ K

## Temperature response data table (typical)—See Appendix G for expanded response table

	102A			202A			103A		
	R ( $\Omega$ )	dR/dT ( $\Omega$ /K)	(T/R)-(dR/dT)	R ( $\Omega$ )	dR/dT ( $\Omega$ /K)	(T/R)-(dR/dT)	R ( $\Omega$ )	dR/dT ( $\Omega$ /K)	(T/R)-(dR/dT)
0.05 K	63765	-2888654	-2.27	69191	-3186379	-2.3	—	—	—
0.1 K	19400	-266199	-1.37	21927	-256913	-1.17	—	—	—
0.3 K	5615	-16647	-0.89	8079	-18420	-0.68	—	—	—
1.4 K	2005	-667	-0.47	3820	-879	-0.32	30745	-13571	-0.62
4.2 K	1370	-80.4	-0.25	2929	-124	-0.18	18149	-1559	-0.36
10 K	1167	-15.2	-0.13	2582	-31.6	-0.12	14083	-337	-0.24
20 K	1089	-3.96	-0.07	2389	-12.1	-0.1	12289	-102	-0.17
40 K	1049	-1.03	-0.04	2243	-4.6	-0.08	11137	-33	-0.12
40 K	1049	-1.06	-0.04	2244	-4.58	-0.08	11150	-21.7	-0.08

## Range of use

	Minimum limit	Maximum limit
RX-102A-AA	0.05 K	40 K
RX-202A-AA	0.05 K	40 K
RX-103A-AA	1.4 K	40 K

## Long-term stability

	RX-102A-AA	RX-202A-AA	RX-103A-AA
4.2 K	$\pm 30$ mK	$\pm 50$ mK	$\pm 15$ mK

## Calibrated accuracy<sup>5</sup>

	RX-102A-AA	RX-202A-AA	RX-103A-AA
20 mK	—	—	—
50 mK	—	—	—
1.4 K	$\pm 16$ mK	$\pm 16$ mK	$\pm 16$ mK
4.2 K	$\pm 16$ mK	$\pm 16$ mK	$\pm 17$ mK
10 K	$\pm 18$ mK	$\pm 18$ mK	$\pm 22$ mK

<sup>5</sup>  $[(\text{Calibration uncertainty})^2 + (\text{reproducibility})^2]^{0.5}$  for more information see Appendices B, D, and E





**Typical magnetic field-dependent temperature errors  $\Delta T/T$  (%) at B (magnetic induction)**

Rox™ 102A				
	2.5 T	8 T	14 T	19 T
2 K	-1.4	-7.9	-13	-17
3 K	-1.5	-7	-14	-18
4 K	-0.56	-6.7	-14	-18
8 K	-1.3	-6.1	-13	-21
16 K	-0.40	-3.4	-9.6	-16
23 K	-0.31	-2.2	-6.2	-11

Rox™ 202A				
	2.5 T	8 T	14 T	19 T
2 K	-0.13	-2.2	-3.9	-5.2
3 K	0.18	-0.68	-2.7	-3.7
4 K	0.77	0.046	-1.8	-3.2
8 K	-0.023	0.16	-0.65	-3.0
16 K	0.03	0.16	-0.48	-1.5
23 K	-0.05	-0.08	-0.39	-0.92

Rox™ 103A				
	2.5 T	8 T	14 T	19 T
2 K	0.58	1.5	2.2	2.6
3 K	0.44	1.1	1.7	2.0
4 K	0.27	0.95	1.4	1.7
8 K	0.11	0.49	0.71	0.80
16 K	0.018	0.076	0.089	0.040
23 K	0.0051	0.0058	-0.0060	-0.095

**Magnetic field dependance data for sample interchangeable Rox™**

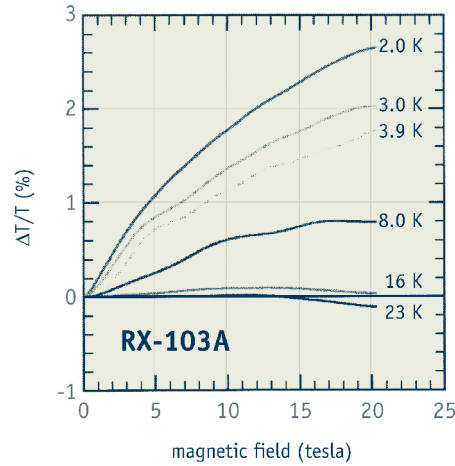
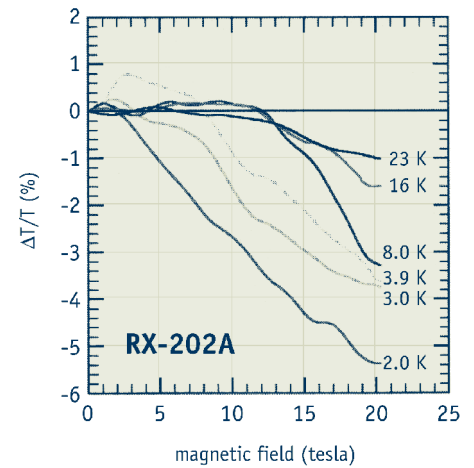
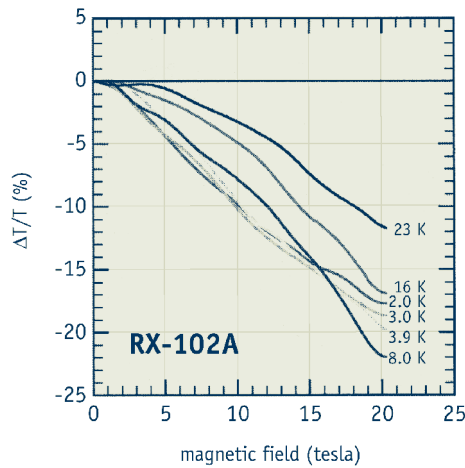

**RX-AA**

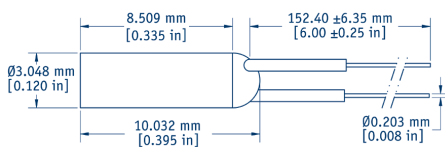

General tolerance of  $\pm 0.127$  mm [ $\pm 0.005$  in] unless otherwise noted

**Bare chip (see table on 50)**

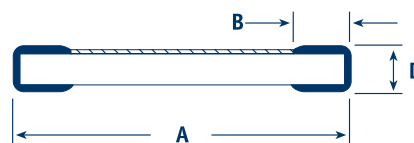
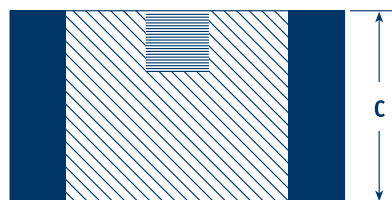

### Packaging options

For more information on sensor packages and mounting adapters, see page 20.

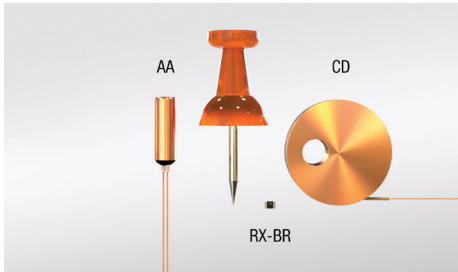

See the appendices for a detailed description of:

Installation  
Uncalibrated sensors  
SoftCal™  
Calibrated sensors  
CalCurve™  
Sensor packages

To add length to sensor leads see page 25.

### Packaging

The Rox™ 202A, 102A, and 103A sensors are available in the Lake Shore standard copper AA canister. Two are available as bare chips for applications requiring a smaller sensor or a faster thermal response time. The RX-102A-BR is a bare chip version of RX-102A. This bare chip features wrap-around noble metal contacts that can be soldered to using standard lead/tin solder. The RX-103A-BR is a bare chip version of the RX-103A. This bare chip has wrap-around pretinned contacts that can be soldered to using standard lead/tin solder. The pretinned contacts increase the sensor thickness from 0.25 mm to 0.41 mm. Leads are not attached to these models, so they are not available as matched or calibrated.

See the Physical Specifications for details and individual dimensions.

### Physical specifications

	Mass	Lead type	Internal atmosphere
RX-102A-AA	3.3 g	Two 6 in 32 AWG copper leads with heavy build Formvar® attached with epoxy strain relief at sensor—user should branch to 4 (no polarity)	Air
RX-202A-AA	3.28 g		
RX-103A-AA	3.36 g		

Bare chip	A (chip length)	B (pad width)	C (chip width)	D (thickness)
RX-102A-BR	1.45 mm (0.057 in)	0.30 mm (0.012 in)	1.27 mm (0.050 in)	0.65 mm (0.022 in)
RX-103A-BR	1.40 mm (0.070 in)	0.21 mm (0.010 in)	1.23 mm (0.060 in)	0.41 mm (0.016 in)

### Ordering information

Rox™ RTD	Calibration range suffix codes Numeric figure is the low end of the calibration Letters represent the high end: B=40 K, M = matched (calibration of matched sensors is available—consult Lake Shore)			
Part number	Uncal	0.05B	0.3B	1.4B
RX-202A-AA, CD	■	■	■	■
RX-202A-AA-M	■			
RX-102A-AA, CD	■	■	■	■
RX-102A-AA-M	■			
RX-102A-BR	■			
RX-103A-AA, CD	■			■
RX-103A-AA-M	■			
RX-103A-BR	■			

#### Accessories available for sensors

8000-CD Calibration report on CD-ROM  
8000-USB Calibration report on USB  
COC-SEN Certificate of conformance



#### Accessories suggested for installation— see Accessories section for full descriptions

Stycast® epoxy  
Apiezon® grease  
90% Pb, 10% Sn solder

Indium solder  
VGE-7031 varnish  
Phosphor bronze wire  
Manganin wire



## PT-100 Series Platinum RTDs

### PT-100 Series features

- Temperature range: 14 K to 873 K (model dependant)
- Conforms to IEC 751 standards down to 70 K
- High reproducibility:  $\pm 5$  mK at 77 K
- Low magnetic field dependence above 40 K
- Excellent for use in ionizing radiation
- SoftCal™ calibration available
- Non-magnetic packages available (PT-103 variants)

### Matching

*If your application requires more than one platinum resistor, up to five platinum resistors can be matched to one another to within  $\pm 0.1$  K at liquid nitrogen temperature with the purchase of only one calibration.*

PT-100 platinum resistance thermometers (PRTs) are an excellent choice for use as cryogenic temperature sensing and control elements in the range from 30 K to 873 K ( $-243$  °C to  $600$  °C). Over this temperature span, PRTs offer high repeatability and nearly constant sensitivity ( $dR/dT$ ). Platinum resistors are also useful as control elements in magnetic field environments where errors approaching one degree can be tolerated. PRTs are interchangeable above 70 K. The use of controlled-purity platinum assures uniformity from one device to another.

PRTs experience rapidly decreasing sensitivity below approximately 30 K. They should be calibrated in order to achieve maximum accuracy for use below 100 K. The plot illustrates platinum sensor conformance to the IEC 751 curve.

### Packaging options

AL, AM

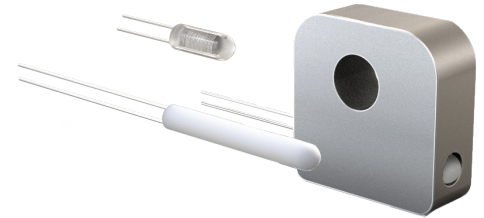

### Typical platinum resistance

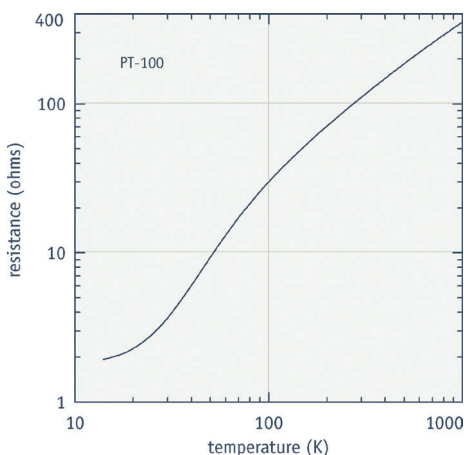

### Typical platinum sensitivity

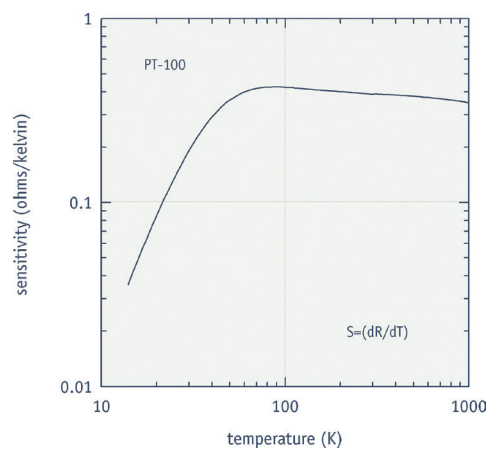

### Typical platinum dimensionless sensitivity

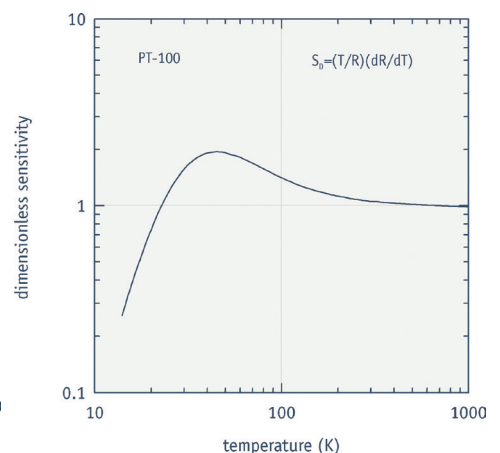

## Specifications

**Standard curve** IEC 751

**Recommended excitation** 1 mA

**Dissipation at recommended excitation** 100  $\mu$ W at 273 K

**Thermal response time** PT-103: 1.75 s at 77 K, 12.5 s at 273 K; PT-111: 2.5 s at 77 K, 20 s at 273 K

**Use in radiation** Recommended for use in ionizing radiation environments—see Appendix B

**Use in magnetic field** Because of their relatively low magnetic field dependence above 30 K, platinum sensors are useful as control elements in magnetic field applications when some error can be tolerated—see Appendix B

**Reproducibility**<sup>1</sup>  $\pm 5$  mK at 77 K

**Soldering standard** J-STD-001 Class 2

<sup>1</sup> Short-term reproducibility data is obtained by subjecting sensor to repeated thermal shocks from 305 K to 77 K

## PT-100 Series interchangeability

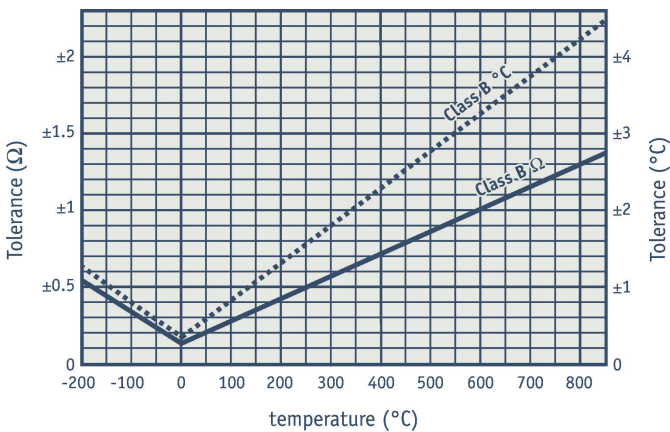

## Physical specifications

	Mass	Lead type	Internal atmosphere	Maximum vacuum	Non-magnetic package
PT-103	120 mg	2, platinum	Fully filled powder	$1 \times 10^{-4}$ Pa	Yes
PT-111	52 mg	2, platinum-coated nickel	Solid glass	$1 \times 10^{-7}$ Pa	No

## Range of use

	Minimum limit	Maximum limit
PT-103	14 K	873 K
PT-111	14 K	673 K

## SoftCal™ accuracy

	30 K to 305 K	305 K to 400 K	400 K to 475 K	475 K to 500 K	500 K to 670 K
2S	$\pm 0.25$ K	$\pm 0.9$ K	$\pm 1.3$ K	$\pm 1.4$ K	$\pm 2.3$ K
3S	$\pm 0.25$ K	$\pm 0.25$ K	$\pm 0.25$ K	$\pm 1.4$ K	$\pm 2.3$ K

2S: 77 K and 305 K

3S: 77 K, 305 K and 480 K

## Calibrated accuracy

	Typical sensor accuracy <sup>2</sup>		Long-term stability <sup>3</sup>
	Calibrations to 800 K	All other calibrations	
30 K	$\pm 10$ mK	$\pm 10$ mK	—
77 K	$\pm 12$ mK	$\pm 12$ mK	$\pm 10$ mK
305 K	$\pm 23$ mK	$\pm 23$ mK	—
400 K	$\pm 210$ mK	$\pm 41$ mK	—
500 K	$\pm 210$ mK	$\pm 46$ mK	—
800 K	$\pm 310$ mK	—	—

<sup>2</sup>  $[(\text{Calibration uncertainty})^2 + (\text{reproducibility})^2]^{0.5}$  for more information see Appendices B, D, and E

<sup>3</sup> If not heated above 475 K—long-term stability data is obtained by subjecting sensor to 200 thermal shocks from 305 K to 77 K

## Typical magnetic field-dependent temperature errors<sup>4</sup> $\Delta T/T$ (%) at B (magnetic field)

	Package parallel to field B				
	2.5 T	5 T	8 T	14 T	19 T
20 K	20	—	100	250	—
40 K	0.5	1.5	3	6	8.8
87 K	0.04	0.14	0.4	1	1.7
300 K	0.01	0.001	0.02	0.07	0.13

<sup>4</sup> Recommended for use when  $T \geq 30$  K

## Temperature response data table (typical)

See Appendix G for expanded response table

	PT-100		
	R ( $\Omega$ )	S ( $\Omega/K$ )	(T/R)(dR/dT)
20 K	2.2913	0.085	0.74
50 K	9.3865	0.360	1.90
77 K	20.380	0.423	1.60
150 K	50.788	0.409	1.20
300 K	110.354	0.387	1.10
600 K	221.535	0.372	1.00
800 K	289.789	0.360	1.00

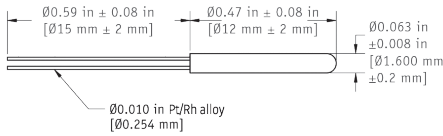
**PT-103**

General tolerance of  $\pm 0.010$  in [ $\pm 0.254$  mm] unless otherwise noted

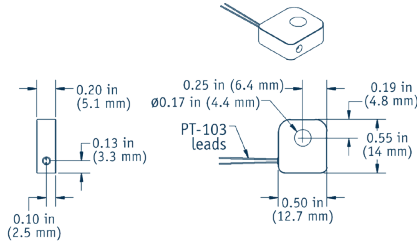
**PT-103-AM**

General tolerance of  $\pm 0.010$  in [ $\pm 0.254$  mm] unless otherwise noted

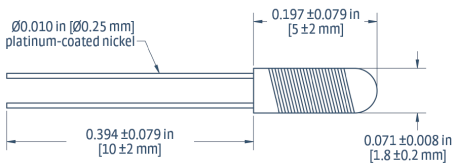
**PT-111****Ordering information**

**Uncalibrated sensor**—Specify the model number in the left column only, for example PT-103.

**Calibrated sensor**—Add the calibration range suffix code to the end of the model number, for example PT-103-14L.

Platinum RTD	Calibration range suffix codes Numeric figure is the low end of the calibration Letters represent the high end: S=SoftCal™, L=325 K, H = 500 K, J = 800 K					
Part number	Uncal	2S	3S	14L	14H	14J
PT-103	■	■	■	■	■	■
PT-103-AM	■	■	■	■	■	■
PT-111	■	■	■	■	■	■

ADD -LN\* Matching PT sensors to  $\pm 0.1$  K at 77 K

\*MUST be purchased with all matching sensors, as well as with the sensor to be matched

**Notes:**

- Upper temperature of AL and AM packages is limited to 800 K.
- If your application requires more than one platinum resistor, up to five platinum resistors can be matched with one another to within  $\pm 0.1$  K at liquid nitrogen temperature with the purchase of only one calibration. If absolute accuracy is required, one of these matched RTDs can be calibrated. For larger quantities, or for different requirements, consult Lake Shore. At the time of order, add -LN to the model number.  
Example: PT-103-14L-LN is a PT-103-LN RTD with a calibration range of 14 K to 325 K that is matched with at least one other uncalibrated PT-103 to within  $\pm 0.1$  K at liquid nitrogen temperature.
- For metrological applications below 30 K, use a germanium RTD. PT-100 sensors are not useful below 14 K for metrology and are of limited use below 30 K for temperature control, due to rapid decline in sensitivity.
- For use above 500 K, anneal at  $T_{max} + 10$  °C for 4 h.

**Accessories available for sensors**

8000-CD Calibration report on CD-ROM  
8000-USB Calibration report on USB  
COC-SEN Certificate of conformance

**Accessories suggested for installation—**

see **Accessories section for full descriptions**  
Stycast® epoxy VGE-7031 varnish  
Apiezon® grease Phosphor bronze wire  
90% Pb, 10% Sn solder Manganin wire  
Indium solder CryoCable™

**Packaging options**

For more information on sensor packages and mounting adapters, see page 20.



See the appendices for a detailed description of:  
Installation  
Uncalibrated sensors  
SoftCal™  
Calibrated sensors  
CalCurve™  
Sensor packages

To add length to sensor leads see page 25.



# Capacitance Temperature Sensors\*

## Capacitance features

- Virtually no magnetic field-induced errors
- Capable of mK control stability in the presence of strong magnetic fields
- Monotonic in C versus T to nearly room temperature

\* Patent #3,649,891, exclusively assigned to Lake Shore Cryotronics, Inc.

## Temperature reproducibility

Over a period of days, thermal cycling of capacitance sensors can provide variations in their capacitance/temperature values equivalent to several tenths of a degree at 4.2 K, 77 K, and room temperature. Over longer periods of time, variations can reach one degree or more. However, any reduced capacitance,  $C(T)/C(4.2\text{ K})$ , is generally stable to within  $\pm 0.5\text{ K}$ . These variations, or shifts, in the temperature response curve have no effect on the sensor's stability when operating at a given temperature and, therefore, do not impair the sensor's primary function as a control element.

Capacitance sensors (CS) are ideally suited for use as temperature control sensors in strong magnetic fields because they exhibit virtually no magnetic field dependence. Displacement current is not affected by magnetic fields. Consequently, temperature control fluctuations are kept to a minimum when sweeping magnetic field or when changing field values under constant temperature operation.

Because small variations in the capacitance/temperature curves occur upon thermal cycling, calibrations must be transferred to the capacitor from another sensor after cooling for the best accuracy. It is recommended that temperature in zero field be measured with another temperature sensor and that the capacitance sensor be employed as a control element only.

## CS-501GR

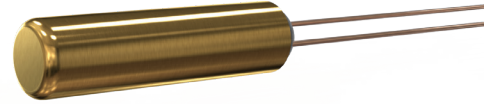
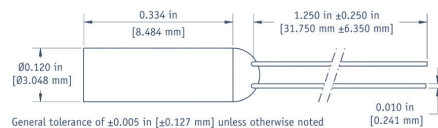

## Temperature stability/temperature transfer accuracy

Capacitance sensors will provide very stable control conditions for long periods of time at operating temperature, but because an operational "aging" phenomenon exists, care must be taken to account for this occurrence in their use.

The variation in capacitance/temperature characteristics is likely the result of the time dependence of the dielectric constant and the dielectric loss, or "aging", that all ferroelectric dielectrics exhibit. This time dependence, which occurs as a short term drift (minutes to hours) in capacitance/temperature value, is initiated by disturbing the sensor thermally or by changing the voltage or frequency of excitation. To compensate for this, the sensor should be stabilized for one hour after initial cool-down to desired operating temperature and whenever significant adjustments in control temperature are made.

After the one hour stabilization, this short-term drift is on the order of a few tenths of a millikelvin per minute at 4.2 K, and several millikelvin per minute at 305 K. The drift is always in the direction of decreasing capacitance; consequently, it corresponds to decreasing temperature below 290 K.

## Typical CS capacitance

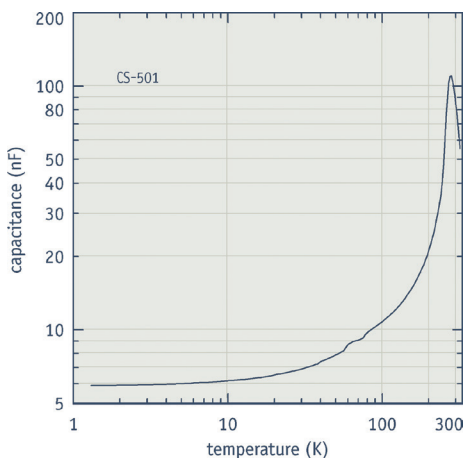

## Typical CS sensitivity

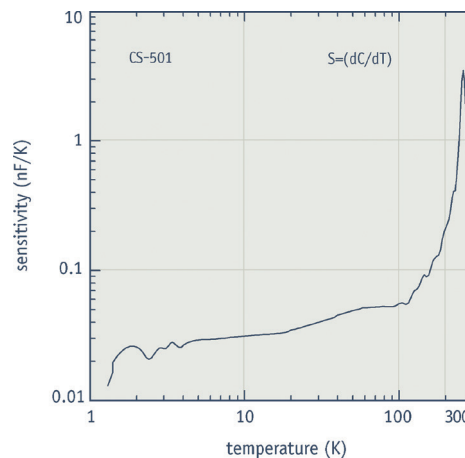

## Typical CS dimensionless sensitivity

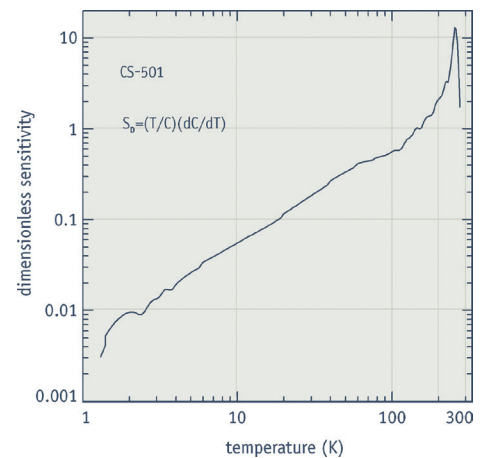



## Specifications

**Standard curve** Not applicable

**Nominal capacitance** 6.1 nF

**Nominal sensitivity** 26 pF/K

**Accuracy (interchangeability)** Not applicable

**Accuracy (calibrated)** Calibration should be performed in situ

**Recommended excitation** 1 to 5 kHz, 0 to 7 V peak to peak or any other acceptable capacitance measuring method

**Dissipation at recommended excitation** Not applicable

**Expected long-term stability**  $\pm 1.0$  K/yr

**Thermal response time** Minutes, dominated by electronic setting time

**Radiation effects** Not available

**Magnetic fields** See table on right

**Reproducibility** See shaded box on previous page for detailed discussion

**Soldering standard** J-STD-001 Class 2

## Range of use

	Minimum limit	Maximum limit
CS-501GR	1.4 K	290 K

## Typical magnetic field-dependent temperature errors<sup>1</sup> $\Delta T/T$ (%) at B (magnetic induction)

Package parallel to field B		18.7 T
4.2 K		-0.15
77 K		<0.05

<sup>1</sup> Recommended for control purposes; monotonic in C vs T to nearly room temperature; frequency dependent

## Packaging options

For more information on sensor packages and mounting adapters, see page 20.

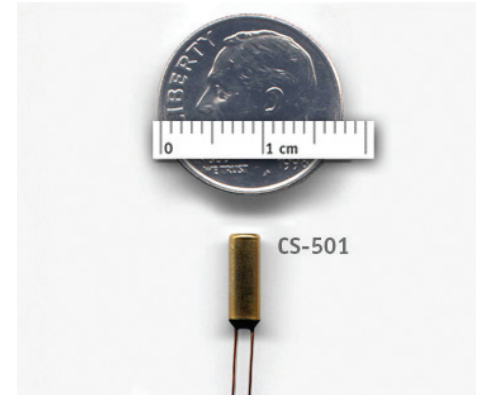

See the appendices for a detailed description of:

Installation  
Uncalibrated sensors  
SoftCal™  
Calibrated sensors  
CalCurve™  
Sensor packages

To add length to sensor leads see 25.

## Physical specifications

	Size	Mass	Lead Type	Internal atmosphere
CS-501	3.0 mm × 8.5 mm long	260 mg	2 phosphor bronze with heavy build polyimide attached with epoxy strain relief at sensor	Air

## Ordering Information

Capacitance sensor	Uncalibrated sensor Specify part number CS-501GR
Part number	Uncal
CS-501GR	■

Accessories suggested for installation—see Accessories section for full descriptions

Stycast® epoxy  
Apiezon® grease  
90% Pb, 10% Sn solder  
Indium solder  
VGE-7031 varnish  
Phosphor bronze wire  
Manganin wire  
CryoCable™





# Thermocouple Wire

## Thermocouple features

- Type E (chromel-constantan) has the highest sensitivity among the standard thermocouple types typically used at low temperatures. The best choice for temperatures down to 40 K.
- Type K (chromel-alumel) Recommended for continuous use in inert atmospheres. Has a sensitivity of 4.1 mV/K at 20 K (about ½ of Type E).

Thermocouple wire is used in a variety of cryogenic applications, but special techniques must be employed to approach temperature accuracies of 1% of temperature, even without consideration for the effects of high magnetic fields or high radiation fluxes. The problems are further complicated by exposure to variable gradient conditions at cryogenic temperatures.

Many Lake Shore temperature controllers offer inputs that accommodate most common types of cryogenic thermocouple wire in use.

### Note:

Heat conduction down the thermocouple wire is the same as with lead wire going to any other sensing device. Refer to Appendix C: Conduction (Lead Attachment) for more detailed information.

See Appendix G for thermocouple curve data.



## Typical magnetic field-dependent temperature errors<sup>1</sup> $\Delta T/T$ (%) at B (magnetic induction)

	Type E thermocouple <sup>2</sup>		
	2.5 T	8 T	14 T
10 K	1	3	7
20 K	<1	2	4
45 K	<1	<1	2

<sup>2</sup> Useful when  $T \geq 10$  K. Refer to comments for chromel-AuFe (0.07%)

## Range of use

	Minimum limit	Maximum limit <sup>3</sup>
Type E	3.15 K	953 K
Type K	3.15 K	1543 K

<sup>3</sup> Upper limit dependent on wire size; to achieve higher than 473 K, insulation must be removed

## Part number Explanation

**TC** = Thermocouple  
**Y** = Wire type, E or K  
**ZZ** = Wire diameter excluding insulation  
**XX** = Wire length in meters

	Wire gauge	
	30 AWG	36 AWG
Type E	TC-E-30-XX	TC-E-36-XX
Type K	TC-K-30-XX	TC-K-36-XX

## Ordering information

Thermocouple wire	36 AWG = 0.005 in (0.127 mm) diameter wire, excluding insulation 30 AWG = 0.010 in (0.254 mm) diameter wire, excluding insulation All thermocouple wire is Teflon® insulated—76.2 µm wall
Part number	Description
TC-Y-ZZ-03	Thermocouple wire — 3 m
TC-Y-ZZ-06	Thermocouple wire — 6 m
TC-Y-ZZ-10	Thermocouple wire — 10 m
TC-Y-ZZ-20	Thermocouple wire — 20 m
TC-Y-ZZ-50	Thermocouple wire — 50 m











# Instruments

- 60 Instrument Selection Guide
- 65 Model 372 AC Resistance Bridge
- 79 Model 350 Temperature Controller
- 87 Model 336 Temperature Controller
- 95 Model 335 Temperature Controller
- 102 Model 325 Temperature Controller
- 108 240 Series Temperature Sensor Modules
- 115 Model 224 Temperature Monitor
- 121 Model 218 Temperature Monitor
- 126 Model 211 Temperature Monitor
- 130 Model 121 DC Current Source





## Instrument Selection Guide

### How to select a temperature instrument for your application

Lake Shore offers the most comprehensive line of cryogenic temperature instruments in the world. The instruments described in this section are designed and manufactured for both general and specific temperature research applications in mind. For much of its history, Lake Shore has focused on instrumentation used for the precise measurement of temperatures from near absolute zero to well above room temperature.

Unfortunately, you can't have it all in one instrument. The most precise and accurate temperature instruments optimized for operation below 100 mK work with fewer sensors and provide lower heater power. The stable and high-resolution instruments designed for general cryogenic use work well for nearly any application, but can have limitations in rare circumstances. Choosing the appropriate instrument for a particular application necessitates prioritizing the requirements for that application.

**Any one or several of the following factors may be important to you in selecting an instrument, whether temperature control or temperature monitoring is required:**

- Operating temperature range
- Number of sensor inputs
- Sensor type compatibility
- Sensor input resistance and voltage ranges
- Current excitation ranges and methods
- High measurement resolution
- High electronic accuracy
- Control stability
- Number of reading displays
- Interfaces
  - Ethernet
  - USB
  - IEEE-488
  - RS-232C
  - Alarms
  - Relays
  - Analog outputs
  - Digital I/O
  - Data logging
- Number of control loops, control type, and operating parameters
- Heater power and ranges
- Cost

The tables on the following pages are designed to compare the instruments more easily with regard to sensor compatibility, operating temperature range, control capability, display features, and interface flexibility.

Our experienced sales staff is here to answer your questions. If you already know what your needs are, please inform us. Otherwise we ask a lot of questions to inform, educate, and to assist you in selecting the correct instrument.



# Temperature controller temperature ranges

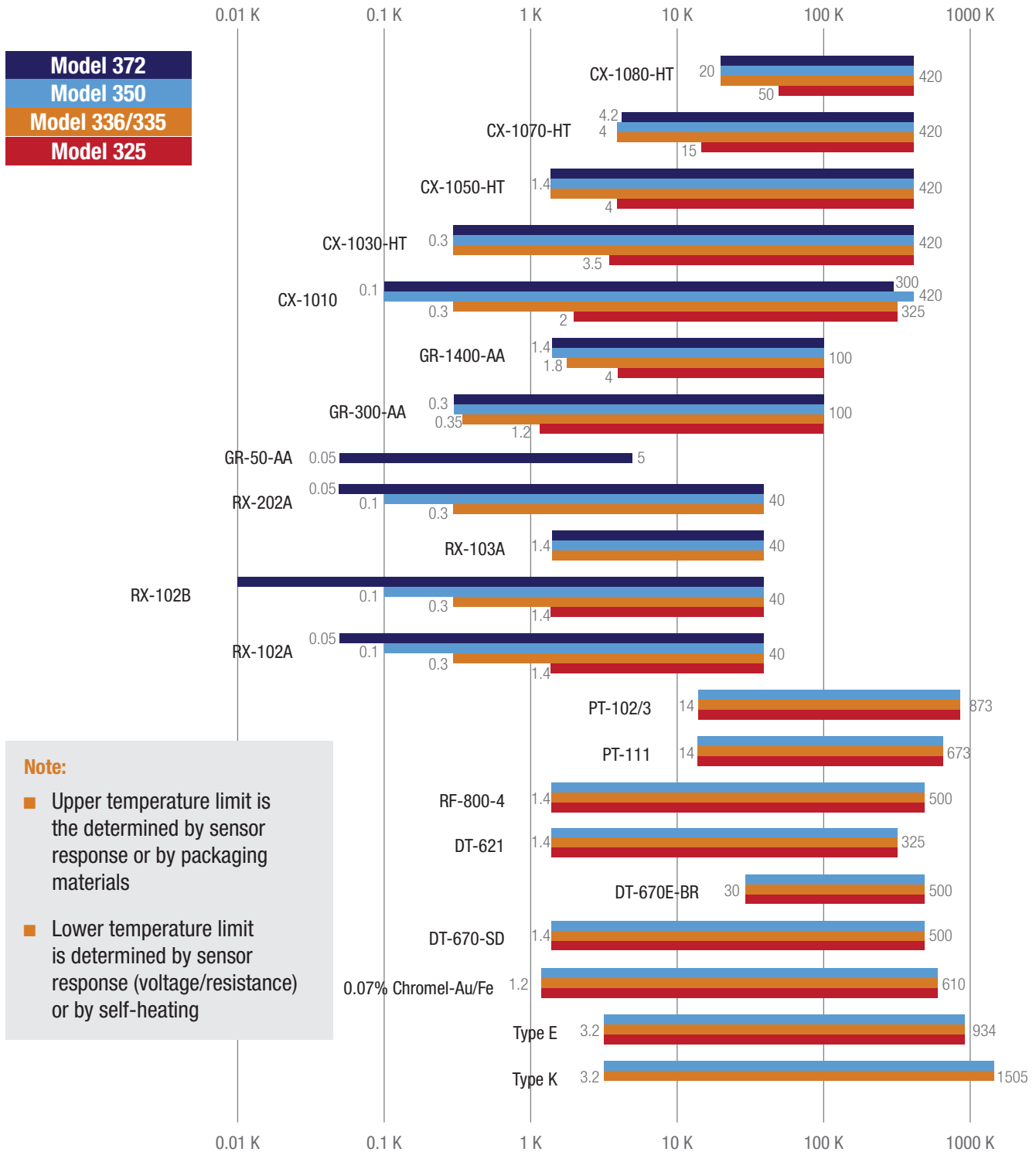



## Current excitation ranges

	3.16 pA	10 pA	31.6 pA	100 pA	316 pA	1.0 nA	3.16 nA	10 nA	31.6 nA	100 nA	316 nA	1 μA	3.16 μA	10 μA	31.6 μA	100 μA	316 μA	1 mA	3.16 mA	10 mA	31.6 mA	
372																						
350																						
336																						
335																						
325																						

	AC bridge	Controllers				
	372	350	336	335	325	
Number of sensor inputs	1 to 16 <sup>1</sup>	8 <sup>1</sup>	4	2	2	
Number of user curves	20	39	39	39	15	
Minimum operating temperature	<20 mK	100 mK	300 mK	300 mK	1.2 K	
Maximum operating temperature	420 K	1505 K	1505 K	1505 K	1505 K	
Current reversal	Yes	Yes	Yes	Yes	Yes	
Current excitation autoranging	Yes	Yes	Yes	Yes	—	
Number of reading displays	1 to 8	1 to 8	1 to 8	1 to 4	1 to 4	
Interfaces						
Ethernet	—	Yes	Yes	—	—	
USB	—	Yes	Yes	Yes	—	
IEEE-488.2	Yes	Yes	Yes	Yes	Yes	
RS-232C	Yes	—	—	—	Yes	
Number of alarms	32	8	4	2	—	
Number of relays	2	2	2	2	—	
Analog voltage output	2 at ±10 V	2 at ±10 V	2 at ±10 V	1 at ±10 V	0 to 10 V	
Number of autotuning control loops	1	1	2	2	2	
Maximum heater output power						
Control loop 1	1 W	75 W	100 W	75 W <sup>2</sup>	25 W	
Control loop 2	—	50 W	50 W	25 W	2 W	
Number of heater ranges	8	5	3	3	2	

<sup>1</sup> Optional input card or scanner

<sup>2</sup> 75 W only available when output 2 is in voltage mode; maximum in other modes 50 W



# Temperature monitor temperature ranges

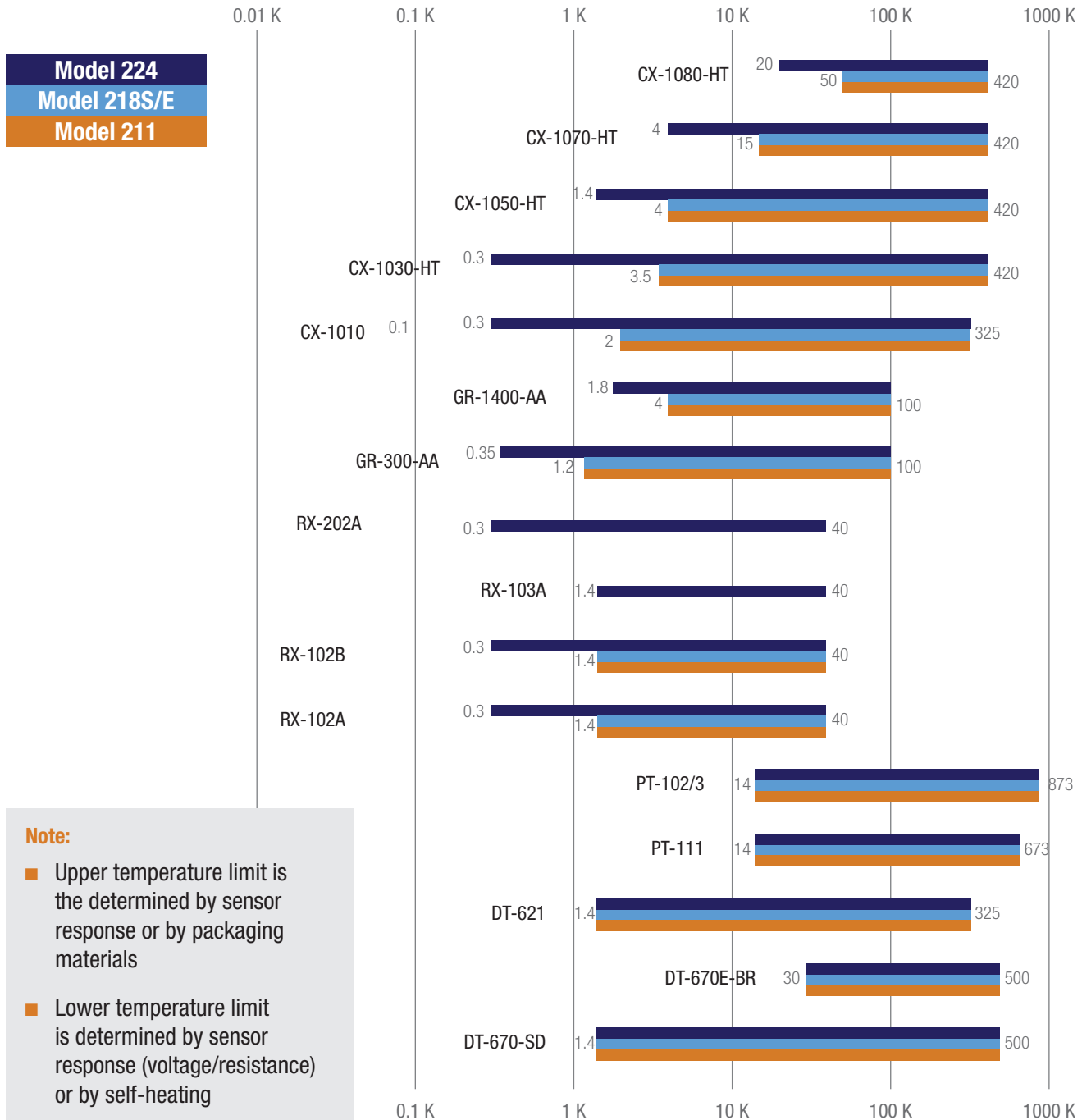



## Current excitation ranges

	31.6 nA	100 nA	316 nA	1 $\mu$ A	3.16 $\mu$ A	10 $\mu$ A	31.6 $\mu$ A	100 $\mu$ A	316 $\mu$ A	500 $\mu$ A	1 mA
224											
218S/E											
211											

	Monitors			
	224	218S	218E	211
Number of sensor inputs	12	8	8	1
Number of user curves	39	8	8	1
Minimum operating temperature	0.3 K	1.2 K	1.2 K	1.2 K
Maximum operating temperature	873 K	800 K	800 K	800 K
Current reversal	Yes	—	—	—
Current excitation autoranging	Yes	—	—	—
Number of reading displays	1 to 16	1 to 8	1 to 8	1
Interfaces				
IEEE-488.2	Yes	Yes	—	—
USB	Yes	—	—	—
Ethernet	Yes	—	—	—
RS-232C	—	Yes	Yes	Yes
Number of alarms	12	16	16	2
Number of relays	2	8	—	2
Analog voltage output	—	2 at $\pm 10$ V	—	0 – 10 V
4 – 20 mA output	—	—	—	Yes
Data logging	Yes	Yes	Yes	—

<sup>3</sup> Uses 5 mV or 10 mV constant voltage





# Model 372 AC Resistance Bridge

## and temperature controller



### Model 370 features

- Patented noise rejection technology
- Highly versatile and reliable measurement input
- Ability to increase the number of measurement channels to a maximum of 16 with optional 3726 scanner
- Dedicated input for ultra-low temperature control
- Powerful impedance measurement capabilities such as quadrature measurements
- Multiple PID controllable outputs with up to 10 W of heater power available
- Latest generation front panel for ease of use
- 3-year standard warranty





## Introduction

The Model 372 AC resistance bridge and temperature controller builds on the solid foundation provided by the original Lake Shore AC resistance bridge. The Model 372 provides the best possible temperature measurement and control capabilities for dilution refrigerators (DRs) that are intended to be operated below 100 mK. The Model 372 makes it easy to perform multiple tasks that were once very difficult to perform reliably at ultra-low temperatures:

- Temperature measurement
- Automatic or manual temperature control
- Device or sample impedance measurements

## Targeted applications

### Ultra-low temperature measurement

Making measurements below 100 mK is far from a trivial exercise, with even the smallest amounts of added energy leading to self-heating and unwanted temperature shifts. Every design decision made on the Model 372 aims to minimize the amount of energy needed to take measurements.

### Noise rejection

Externally generated electronic noise can be a major cause of self-heating if it is allowed to couple into the device under test. Thankfully, multiple noise-rejection strategies have been implemented to reduce this effect substantially:

- Our patented\* balanced noise-rejecting current source ensures that external signals have no path to ground through the measurement circuit, effectively making the Model 372 unaltered by these noise sources.
- The measurement signal cables use a driven guard that reduces parasitic capacitance in the cables that connect a scanner to the Model 372. This helps to further balance the measurement network and bolster the integrity of the noise rejection circuitry.
- All measurement circuitry is isolated from other instrument components, limiting the impact of any small electrical disturbances.
- The AC frequency options used for the measurement signal are selected to be naturally resilient to line voltage frequencies (50 and 60 Hz).

### AC measurement signals

By using alternating current (AC) measurement in tandem with a specially designed internal lock-in amplifier, the Model 372 is able to extract very small measurement signals from background noise. This allows for much lower excitation levels to be used when compared to traditional direct current (DC) systems, minimizing the amount of energy that is dissipated into the device under test.

These AC excitation levels can be set to as low as 10 pA, while still maintaining accuracy of better than 1% over quite a wide range of resistances. This enables impedance and temperature measurements to be made while adding power levels so small that they are measured in the attowatt range ( $10^{-18}$  W). These features are vital in allowing accurate measurement to be made while minimizing the negative effects of self-heating.

### Low noise signal recovery

Due to the very low excitation level used for measurement, the resulting voltage levels must first be boosted to allow those signals to be measured. The internal lock-in amplifier in the Model 372 has been specifically designed to minimize the amount of noise added to the signal. This results in an input noise figure that is less than  $10 \text{ nV}/\sqrt{\text{Hz}}$ , thereby increasing the resolution of measurements and limiting the amount of post-measurement filtering that needs to be applied.

### Temperature measurement

Extremely accurate and reliable ultra-low temperature measurements can be achieved by combining the Model 372 with a negative temperature coefficient (NTC) resistive temperature device (RTD), such as the Lake Shore Cernox®, Rox™ or germanium temperature sensors. Multiple calibration curves can easily be uploaded to the Model 372, allowing highly accurate conversion of sensor resistance to equivalent temperature using cubic spline interpolation (an improved interpolation technique compared to older instruments).

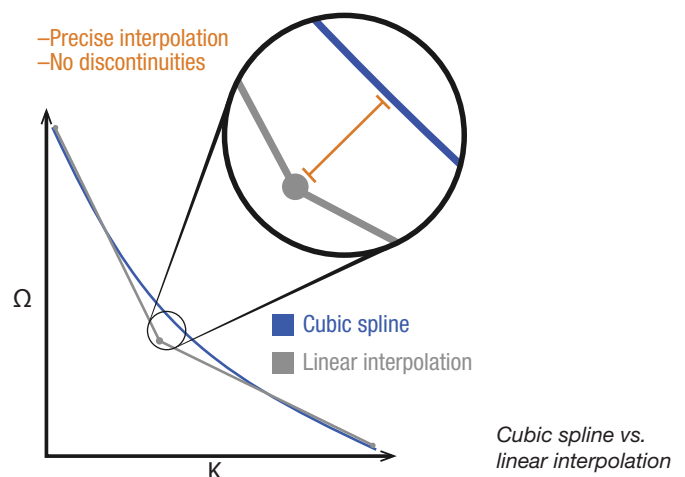



## Model 372 rear panel

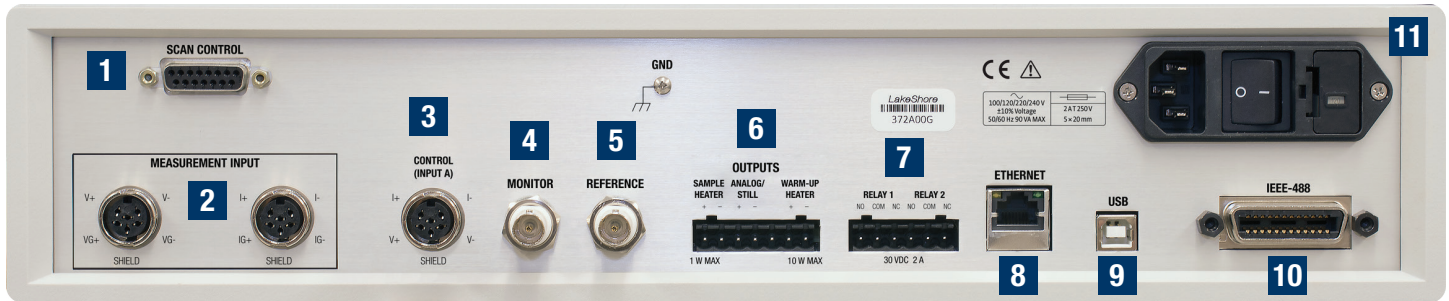

- |  |   |                              |
|--|---|------------------------------|
| 1 Scanner control input (DA-15)            | 5 Reference output (BNC)  | 8 Ethernet interface (RJ-45) |
| 2 Sensor voltage/current input (6-pin DIN) | 6 Sample heater output, warm-up heater output, and still heater output (terminal block) | 9 USB interface (USB Type A) |
| 3 Secondary control input (6-pin DIN)      | 7 Relay 1 and 2 (terminal block)  | 10 IEEE-488.2 interface      |
| 4 Monitor output (BNC)                     |   | 11 Line power/fuse assembly  |

User-generated calibration curves can also be created and loaded into the Model 372, allowing great flexibility in the type of resistive sensors that are used. A maximum of 39 calibration curves can be stored on the instrument, and when used with a 3726 scanner, up to 17 sensors can be connected simultaneously, each with their own curve.

### Measure a wide range of resistive devices

With up to 22 different current (I) excitation levels available, the Model 372 is able to perform accurate impedance measurements from several microohms ( $10^{-6} \Omega$ ) to many megohms ( $10^6 \Omega$ ), all while keeping power dissipation levels to an absolute minimum.

The addition of full quadrature measurements means that both the resistive and reactive components of an impedance can now be measured. This enables much better characterization of the device under test by allowing capacitive or inductive components to be measured.



The new 3726 scanner option

### Expandability

For situations where temperature measurements must be taken at multiple locations, the 3726 scanner and preamp can be paired with the Model 372 to provide up to 16 connections for 4-wire resistance measurements. The Model 372 can switch measurement to any one of these connections as required, removing the need to physically switch cables on the instrument to look at different sensors. The measurement signal is also boosted by a pre-amp circuit in the 3726, preserving the signal-to-noise ratio between the sensor and measurement circuitry of the Model 372. This allows connection cables of up to 10 m to be used between the Model 372 and the 3726.

In cases where measurements are required at multiple locations simultaneously within an experiment space, additional Model 372 units may be used together. Five different AC excitation frequencies are available for this purpose, ensuring that up to five simultaneous measurements can be performed without the risk of co-channel interference.

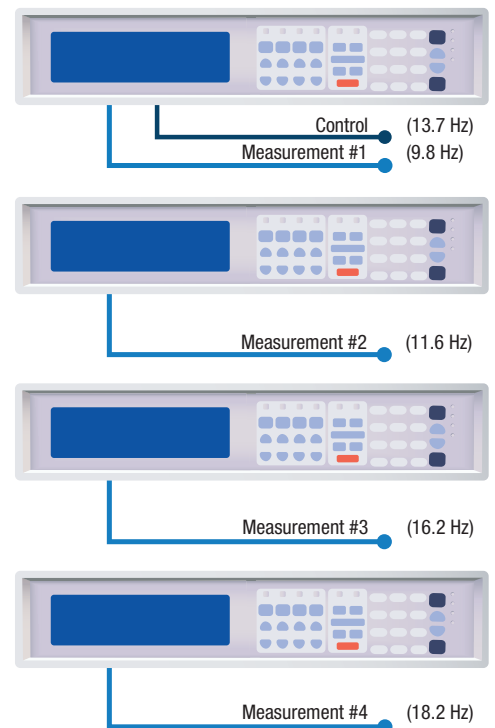



## Dilution refrigerator temperature control

Accurate measurement at ultra-low temperatures are no easy feat, especially when working in the ranges seen by modern dilution refrigerators. The Model 372 has many features specifically developed for dilution refrigerator applications.

### Dedicated temperature control input

Taking measurements at ultra-low temperatures deserves uninterrupted attention from measurement devices. The Model 372 uses a dedicated temperature control input that is designed specifically for connection to a negative temperature coefficient resistive sensor. This input is designed to continuously monitor the temperature of the dilution refrigerator sample holder, while the measurement input scans through the multiple other temperature sensors placed throughout the dilution refrigerator.

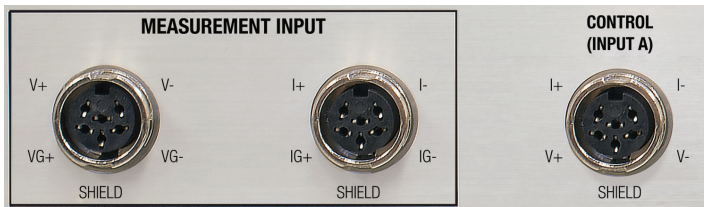

*The dedicated control input ensures uninterrupted dilution refrigerator temperature control*

### Multiple heater options

Three separate heater outputs are available on the Model 372:

- **Sample heater**—for fine control of the sample stage at ultra-low temperatures with up to 1 W of power available.
- **Warm-up heater**—supplying up to 10 W of power and featuring a warm-up mode specifically for the purpose of bringing the system temperature up to allow work to be performed on the sample stage.
- **Still heater**—an additional 1 W heater is available for the purpose of controlling the temperature of a dilution refrigerator's still. Alternatively, this output can provide an analog out signal to other devices if required.

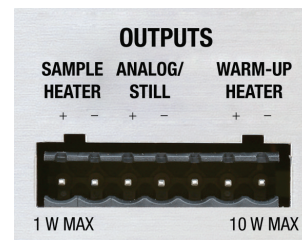

The sample and warm-up heaters have many powerful control options, including PID control that allows both the setting of fixed temperature setpoints as well as ramp rates.

*A Model 372 and 3726 used to control a dilution refrigerator*

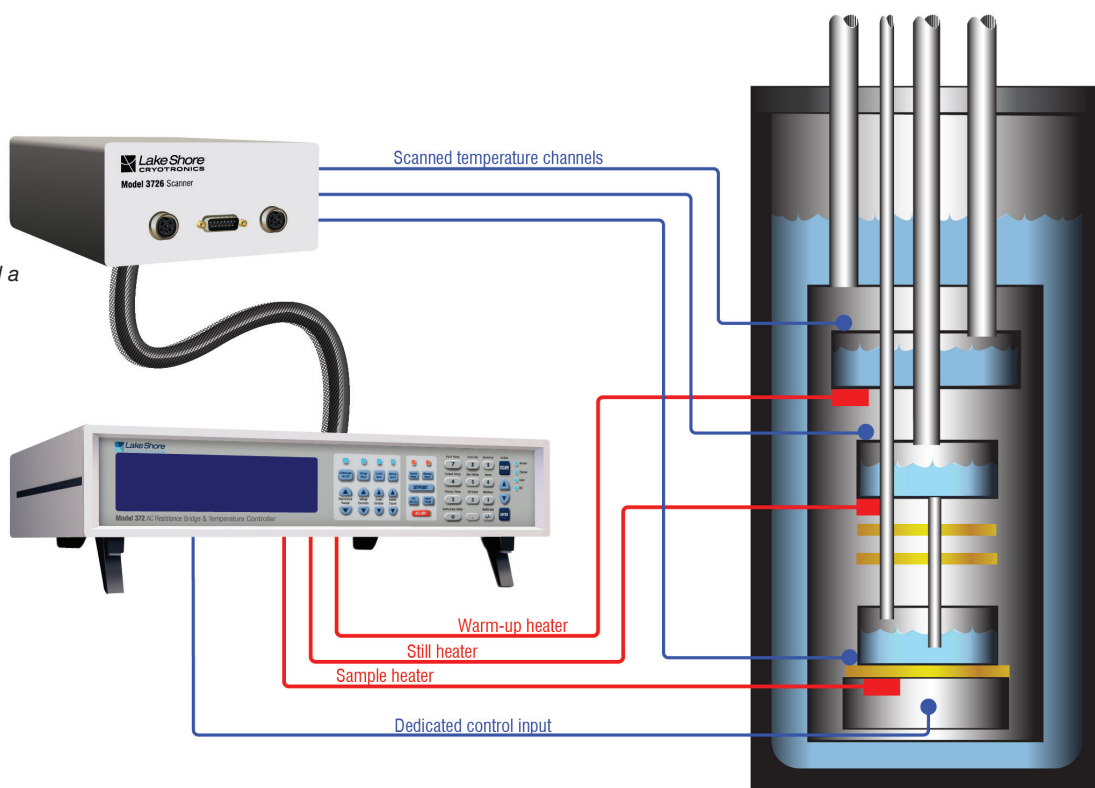



### Stable temperature control

When operating at ultra-low temperatures, even small amounts of added energy can cause unwanted spikes in system temperature. The Model 372 heater outputs implement several protection mechanisms to reduce or eliminate this potential:

- The circuitry for the sample and still heaters are electrically isolated from other instrument sections
- Multiple power range settings allow extremely fine or coarse power transitions, depending on the need
- Heater outputs are shunted during power up and power range changes, eliminating the potential for unwanted power surges
- Terminal connections allow twisted pair cabling to be easily used for heater wiring; additional shielding of these wires can also be added to further reduce the potential of injecting noise into a system via the heater cabling

### Temperature zone control

Thermal response characteristics of a dilution refrigerator system can change quite dramatically over the useful range of operation, particularly down towards the lower temperature limit of a system, where cooling power is reduced. To accommodate these system variations, different PID values can be set for different temperature ranges (zones). This allows for more aggressive transition settings to be used at higher temperatures where system response is faster, and less reactive settings at low temperatures when temperature overshoots result in long recovery times.

### Heater fail-safes

The Model 372 has several features that will protect your system and experiment from accidental deviations in planned temperature settings:

- Temperature thresholds can be set for all heater outputs, meaning the heaters will automatically shut down if it is detected that the system is being overheated.
- An easy-to-hit “ALL OFF” button is provided that shuts all heaters down instantly. This eliminates the terrible experience of having to hurriedly search through menu options while your experiment continues to heat.





## Sensor performance

Excitation ranges in sensor tables were selected to minimize sensor self-heating.

*Excitation power = actual current<sup>2</sup> × example resistance*

**Measurement resolution** comes from electronic instrumentation and sensor thermal noises. Measurement resolution is given by:

*Resolution (Ω) = ((instrument noise)<sup>2</sup> + (sensor thermal noise)<sup>2</sup>)<sup>0.5</sup>*

Electronic instrumentation noise is taken at ambient temperature, while sensor thermal noise is taken at the temperature specified in the following tables.

$$\text{Resolution (K)} = \frac{\text{Resolution}(\Omega)}{(dR/dT)}$$

**Electronic accuracy** is influenced by the measurement range used and sensor resistance value. Electronic accuracy is given by:

*Electronic accuracy (Ω) = Accuracy(%) × example resistance + 0.005% of resistance range*

Where: Accuracy (%) is given in the instrument performance table (pages 10–11)

at the selected current and voltage range

$$\text{Electronic accuracy (K)} = \frac{\text{Electronic accuracy}(\Omega)}{(dR/dT)}$$

**Self-heating errors** are measurement errors due to power dissipation in the sensor causing unwanted temperature rises.

Self-heating error is given by:

*Self heating error = thermal resistance × power*

Thermal resistances specified are typical values resulting from minimal heat sinking.

Improved values can be achieved with permanent installation.

**Calibration accuracies** are based on Lake Shore sensor calibration uncertainty and repeatability values—see Appendices B, D & E of the Temperature Measurement and Control Catalog for more information.

**Interpolation errors** are due to the linear interpolation method used by the Model 372 to convert resistance values to temperatures when using a temperature sensor. These errors are not present when resistance is measured directly.

**Overall accuracy** is a combination of all listed sources of potential error and is given by:

*Overall accuracy = (measurement resolution<sup>2</sup> + electronic accuracy<sup>2</sup> + self heating errors<sup>2</sup> + calibration accuracy<sup>2</sup> + interpolation error<sup>2</sup>)<sup>0.5</sup>*

### Lake Shore Rox™ RX-102B-CB with 0.02 to 40 K calibration

Values given are for measurement input. If the value is different for the control input, it is shown in blue.

Sensor properties				Excitation and instrumentation				Instrument performance		Overall performance			
Temperature	Nominal resistance	Typical sensor sensitivity	Thermal resistance	Resistance range	Excitation voltage limit	Excitation current	Power	Measurement resolution	Electronic accuracy	Calibration accuracy	Self-heating errors	Interpolation error	Overall accuracy
20 mK	7.3 kΩ	-171 kΩ/K	17.2 K/nW	20 kΩ 632 kΩ	6.32 μV 200 μV	316 pA	730 aW	7.3 Ω (42.7 μK) 33.9 Ω (198 μK)	8.3 Ω (48.5 μK) 35.3 Ω (206 μK)	±2 mK	12.6 μK	±0.2 mK	2 mK
30 mK	6.0 kΩ	-100 kΩ/K	8.2 K/nW	6.32 kΩ 200 kΩ	6.32 μV 200 μV	1 nA	6 fW	485 mΩ (4.9 μK) 7.3 Ω (73 μK)	6.3 Ω (63 μK) 13.0 Ω (130 μK)	±4 mK	49.2 μK	±0.2 mK	4 mK
40 mK	5.2 kΩ	-62 kΩ/K	635.8 mK/nW	6.32 kΩ 63.2 kΩ	20 μV 200 μV	3.16 nA	52 fW	502 mΩ (8.1 μK) 1.5 Ω (24.2 μK)	2.9 Ω (46.8 μK) 4.7 Ω (75.8 μK)	±4 mK	33.1 μK	±0.2 mK	4 mK
50 mK	4.7 kΩ	-41 kΩ/K	415.1 mK/nW	6.32 kΩ 63.2 kΩ	20 μV 200 μV	3.16 nA	47 fW	502 mΩ (12.2 μK) 1.5 Ω (36.6 μK)	2.7 Ω (65.9 μK) 4.6 Ω (112 μK)	±4 mK	19.5 μK	±0.2 mK	4 mK
100 mK	3.5 kΩ	-13 kΩ/K	33.2 mK/nW	6.32 kΩ 20 kΩ	63.2 μV 200 μV	10 nA	350 fW	48.6 mΩ (3.7 μK) 338 mΩ (26 μK)	2.1 Ω (162 μK)	±4 mK	11.6 μK	±0.2 mK	4 mK
300 mK	2.5 kΩ	-2.4 kΩ/K	2.8 mK/nW	6.32 kΩ	200 μV	31.6 nA	2.5 pW	50.2 mΩ (20.9 μK) 87 mΩ (36.3 μK)	1.1 Ω (458 μK)	±4 mK	7.0 μK	±0.2 mK	4 mK
1 K	1.9 kΩ	-351 Ω/K	609.6 μK/nW	6.32 kΩ	200 μV	31.6 nA	1.9 pW	50.2 mΩ (143 μK) 87 mΩ (248 μK)	0.9 Ω (2.6 mK)	±4 mK	1.2 μK	±0.2 mK	4.7 mK

**Lake Shore GR-50-AA with 0.05 to 6 K calibration**

Values given are for measurement input. If the value is different for the control input, it is shown in blue.

Sensor properties				Excitation and instrumentation				Instrument performance		Overall performance			
Temperature	Nominal resistance	Typical sensor sensitivity	Thermal resistance	Resistance range	Excitation voltage limit	Excitation current	Power	Measurement resolution	Electronic accuracy	Calibration accuracy	Self-heating errors	Interpolation error	Overall accuracy
50 mK	35 k $\Omega$	-3.6 M $\Omega$ /K	200 mK/nW	63.2 k $\Omega$ 200 k $\Omega$	63.2 $\mu$ V 200 $\mu$ V	1 nA	35 fW	3.4 $\Omega$ (944 nK) 7.3 $\Omega$ (2 $\mu$ K)	20.7 $\Omega$ (5.8 $\mu$ K) 27.5 $\Omega$ (7.6 $\mu$ K)	$\pm$ 4 mK	7.0 $\mu$ K	$\pm$ 0.2 mK	4 mK
100 mK	2317 $\Omega$	-72 k $\Omega$ /K	20 mK/nW	6.32 k $\Omega$ 20 k $\Omega$	63.2 $\mu$ V 200 $\mu$ V	10 nA	232 fW	48.5 m $\Omega$ (674 nK) 338 m $\Omega$ (4.7 $\mu$ K)	1.5 $\Omega$ (20.8 $\mu$ K) 1.7 $\Omega$ (23.6 $\mu$ K)	$\pm$ 4 mK	4.6 $\mu$ K	$\pm$ 0.2 mK	4 mK
300 mK	164 $\Omega$	-964 $\Omega$ /K	4 mK/nW	632 $\Omega$ 2 k $\Omega$	200 $\mu$ V	316 nA 100 nA	16 pW 1.6 pW	3.6 m $\Omega$ (3.7 $\mu$ K) 29 m $\Omega$ (30.1 $\mu$ K)	81 m $\Omega$ (84 $\mu$ K) 149 m $\Omega$ (155 $\mu$ K)	$\pm$ 4 mK	66 $\mu$ K 6.6 $\mu$ K	$\pm$ 0.2 mK	4 mK
500 mK	73.8 $\Omega$	-202.9 $\Omega$ /K	1.2 mK/nW	632 $\Omega$ 2 k $\Omega$	200 $\mu$ V	316 nA 100 nA	7.4 pW 738 fW	3.6 m $\Omega$ (17.7 $\mu$ K) 29 m $\Omega$ (143 $\mu$ K)	54 m $\Omega$ (266 $\mu$ K) 122 m $\Omega$ (601 $\mu$ K)	$\pm$ 4 mK	8.9 $\mu$ K 886 nK	$\pm$ 0.2 mK	4 mK 4.1 mK
1 K	34 $\Omega$	-31 $\Omega$ /K	100 $\mu$ K/nW	200 $\Omega$ 2 k $\Omega$	200 $\mu$ V	1 $\mu$ A 100 nA	34 pW 340 fW	1.2 m $\Omega$ (38.7 $\mu$ K) 29 m $\Omega$ (935 $\mu$ K)	20 m $\Omega$ (645 $\mu$ K) 110 m $\Omega$ (3.5 mK)	$\pm$ 4 mK	3.4 $\mu$ K 34 nK	$\pm$ 0.2 mK	4.1 mK 5.4 mK
1.4 K	24.7 $\Omega$	-13.15 $\Omega$ /K	75 $\mu$ K/nW	200 $\Omega$ 2 k $\Omega$	200 $\mu$ V	1 $\mu$ A 100 nA	25 pW 247 fW	1.2 m $\Omega$ (91.3 $\mu$ K) 29 m $\Omega$ (2.2 mK)	17 m $\Omega$ (1.3 mK) 107 m $\Omega$ (8.1 mK)	$\pm$ 5 mK	1.9 $\mu$ K 19 nK	$\pm$ 0.2 mK	5.2 mK 9.8 mK
4.2 K	13.7 $\Omega$	-1.036 $\Omega$ /K	25 $\mu$ K/nW	20 $\Omega$ 2 k $\Omega$	200 $\mu$ V	10 $\mu$ A 100 nA	1.4 nW 137 fW	120 $\mu$ $\Omega$ (116 $\mu$ K) 29 m $\Omega$ (28 mK)	5.1 m $\Omega$ (4.9 mK) 104 m $\Omega$ (100 mK)	$\pm$ 5 mK	3.5 $\mu$ K 3.4 nK	$\pm$ 0.2 mK	7 mK 104 mK

**Lake Shore CX-1010-SD with 0.1 to 325 K calibration**

Values given are for measurement input. If the value is different for the control input, it is shown in blue.

Sensor properties				Excitation and instrumentation				Instrument performance		Overall performance			
Temperature	Nominal resistance	Typical sensor sensitivity	Thermal resistance	Resistance range	Excitation voltage limit	Excitation current	Power	Measurement resolution	Electronic accuracy	Calibration accuracy	Self-heating errors	Interpolation error	Overall accuracy
100 mK	21.389 k $\Omega$	-558 k $\Omega$ /K	1.4 K/nW	63.2 k $\Omega$ 200 k $\Omega$	63.2 $\mu$ V 200 $\mu$ V	1 nA	21 fW	3.4 $\Omega$ (6.1 $\mu$ K) 7.4 $\Omega$ (13.3 $\mu$ K)	13.9 $\Omega$ (24.9 $\mu$ K) 20.7 $\Omega$ (37.1 $\mu$ K)	$\pm$ 4 mK	30 $\mu$ K	$\pm$ 0.2 mK	4 mK
300 mK	2.3224 k $\Omega$	-10.8 k $\Omega$ /K	26.8 mK/nW	6.32 k $\Omega$	200 $\mu$ V	31.6 nA	2.3 pW	50.2 m $\Omega$ (4.6 $\mu$ K) 87.0 m $\Omega$ (8.1 $\mu$ K)	1.0 $\Omega$ (92.6 $\mu$ K) 1.0 $\Omega$ (93.8 $\mu$ K)	$\pm$ 4 mK	62 $\mu$ K	$\pm$ 0.2 mK	4 mK
500 mK	1.2482 k $\Omega$	-2.7 k $\Omega$ /K	4.3 mK/nW	2 k $\Omega$	200 $\mu$ V	100 nA	12.5 pW	14.5 m $\Omega$ (5.4 $\mu$ K) 29.2 m $\Omega$ (10.8 $\mu$ K)	475 m $\Omega$ (176 $\mu$ K) 474 m $\Omega$ (176 $\mu$ K)	$\pm$ 4 mK	54 $\mu$ K	$\pm$ 0.2 mK	4 mK
4.2 K	277.32 $\Omega$	-32.2 $\Omega$ /K	2 $\mu$ K/nW	632 $\Omega$ 2 k $\Omega$	6.32 mV 200 $\mu$ V	10 $\mu$ A 100 nA	28 nW 2.8 pW	1.3 m $\Omega$ (40.4 $\mu$ K) 29.2 m $\Omega$ (907 $\mu$ K)	115 m $\Omega$ (3.6 mK) 183 m $\Omega$ (5.7 mK)	$\pm$ 4 mK	56 $\mu$ K 5.6 nK	$\pm$ 0.2 mK	5.4 mK 7 mK
300 K	30.392 $\Omega$	-65.4 m $\Omega$ /K	426 fK/nW	63.2 $\Omega$ 2 k $\Omega$	6.32 mV 200 $\mu$ V	100 $\mu$ A 100 nA	304 nW 304 fW	130 $\mu$ $\Omega$ (2.0 mK) 29.2 m $\Omega$ (446 mK)	12.3 m $\Omega$ (188 mK) 109 m $\Omega$ (1.7 K)	$\pm$ 78 mK	130 pK 129 aK	$\pm$ 0.2 mK	203 mK 1.7 K



372/3726 performance specification table

The values below apply to the measurement input. The control input operates over a reduced range indicated by the black-bordered cells. These cells contain bracketed numbers to indicate the resolution that applies to the control input.

		Voltage range																
		632 mV	200 mV	63.2 mV	20 mV	6.32 mV	2 mV	632 $\mu$ V	200 $\mu$ V	63.2 $\mu$ V	20 $\mu$ V	6.32 $\mu$ V	2 $\mu$ V					
Current excitation	31.6 mA	20 $\Omega$ 20 $\mu$ $\Omega$ 10 mW	6.32 $\Omega$ 6.3 $\mu$ $\Omega$ 3.2 mW	2 $\Omega$ 2 $\mu$ $\Omega$ 1 mW	632 m $\Omega$ 1.3 $\mu$ $\Omega$ 320 $\mu$ W	200 m $\Omega$ 400 n $\Omega$ 100 $\mu$ W	63.2 m $\Omega$ 95 n $\Omega$ 32 $\mu$ W	20 m $\Omega$ 36 n $\Omega$ 10 $\mu$ W	6.32 m $\Omega$ 35 n $\Omega$ 3.2 $\mu$ W	2 m $\Omega$ 40 n $\Omega$ 1 $\mu$ W	*	*	*	*				
	10 mA	63.2 $\Omega$ 63 $\mu$ $\Omega$ 3.2 mW	20 $\Omega$ 20 $\mu$ $\Omega$ 1 mW	6.32 $\Omega$ 6.3 $\mu$ $\Omega$ 320 $\mu$ W	2 $\Omega$ 4 $\mu$ $\Omega$ 100 $\mu$ W	632 m $\Omega$ 1.3 $\mu$ $\Omega$ 32 $\mu$ W	200 m $\Omega$ 300 n $\Omega$ 10 $\mu$ W	63.2 m $\Omega$ 120 n $\Omega$ 3.2 $\mu$ W	20 m $\Omega$ 120 n $\Omega$ 1 $\mu$ W	6.32 m $\Omega$ 130 n $\Omega$ 320 nW	2 m $\Omega$ 120 n $\Omega$ 100 nW	*	*	*				
	3.16 mA	200 $\Omega$ 200 $\mu$ $\Omega$ 1 mW	63.2 $\Omega$ 63 $\mu$ $\Omega$ 320 $\mu$ W	20 $\Omega$ 20 $\mu$ $\Omega$ 100 $\mu$ W	6.32 $\Omega$ 13 $\mu$ $\Omega$ 32 $\mu$ W	2 $\Omega$ 4 $\mu$ $\Omega$ 10 $\mu$ W	632 m $\Omega$ 950 n $\Omega$ 3.2 $\mu$ W	200 m $\Omega$ 390 n $\Omega$ 1 $\mu$ W	63.2 m $\Omega$ 370 n $\Omega$ 320 nW	20 m $\Omega$ 400 n $\Omega$ 100 nW	6.32 m $\Omega$ 380 n $\Omega$ 32 nW	2 m $\Omega$ 400 n $\Omega$ 10 nW	*	*	*			
	1 mA	632 $\Omega$ 630 $\mu$ $\Omega$ 3.2E-04	200 $\Omega$ 200 $\mu$ $\Omega$ 100 $\mu$ W	63.2 $\Omega$ 63 $\mu$ $\Omega$ 32 $\mu$ W	20 $\Omega$ 40 $\mu$ $\Omega$ 10 $\mu$ W	6.32 $\Omega$ 13 $\mu$ $\Omega$ 3.2 $\mu$ W	2 $\Omega$ 3 $\mu$ $\Omega$ 1 $\mu$ W	632 m $\Omega$ 1 $\mu$ $\Omega$ 320 nW	200 m $\Omega$ 1 $\mu$ $\Omega$ 100 nW	63.2 m $\Omega$ 1.3 $\mu$ $\Omega$ 32 nW	20 m $\Omega$ 1.2 $\mu$ $\Omega$ 10 nW	6.32 m $\Omega$ 1.3 $\mu$ $\Omega$ 3.2 nW	2 m $\Omega$ 1.3 $\mu$ $\Omega$ 1 nW	*	*			
	316 $\mu$ A	2 k $\Omega$ 2 m $\Omega$ 100 $\mu$ W	632 $\Omega$ 630 $\mu$ $\Omega$ 32 $\mu$ W	200 $\Omega$ 200 $\mu$ $\Omega$ 10 $\mu$ W	63.2 $\Omega$ 130 $\mu$ $\Omega$ 3.2 $\mu$ W	20 $\Omega$ 40 $\mu$ $\Omega$ 1 $\mu$ W	6.32 $\Omega$ 9.5 $\mu$ $\Omega$ 320 nW	2 $\Omega$ 3.7 $\mu$ $\Omega$ 100 nW	632 m $\Omega$ 3.8 $\mu$ $\Omega$ 32 nW	200 m $\Omega$ 4 $\mu$ $\Omega$ 10 nW	63.2 m $\Omega$ 3.8 $\mu$ $\Omega$ 3.2 nW	20 m $\Omega$ 4 $\mu$ $\Omega$ 1 nW	6.32 m $\Omega$ 3.7 $\mu$ $\Omega$ 320 pW	2 m $\Omega$ 3.7 $\mu$ $\Omega$ 320 pW	*			
	100 $\mu$ A	6.32 k $\Omega$ 6.3 m $\Omega$ 32 $\mu$ W	2 k $\Omega$ 2 m $\Omega$ 10 $\mu$ W	632 $\Omega$ 630 $\mu$ $\Omega$ 3.2 $\mu$ W	200 $\Omega$ 400 $\mu$ $\Omega$ 1 $\mu$ W	63.2 $\Omega$ 130 $\mu$ $\Omega$ 320 nW	20 $\Omega$ 30 $\mu$ $\Omega$ 30 nW	6.32 $\Omega$ 12 $\mu$ $\Omega$ 12 nW	2 $\Omega$ 12 $\mu$ $\Omega$ 10 nW	632 m $\Omega$ 13 $\mu$ $\Omega$ 3.2 nW	200 m $\Omega$ 12 $\mu$ $\Omega$ 1 nW	63.2 m $\Omega$ 13 $\mu$ $\Omega$ 320 pW	20 m $\Omega$ 13 $\mu$ $\Omega$ 100 pW	6.32 m $\Omega$ 12 $\mu$ $\Omega$ 100 pW	20 m $\Omega$ 12 $\mu$ $\Omega$ 100 pW	*		
	31.6 $\mu$ A	20 k $\Omega$ 20 m $\Omega$ 10 $\mu$ W	6.32 k $\Omega$ 6.3 m $\Omega$ 3.2 $\mu$ W	2 k $\Omega$ 2 m $\Omega$ 1 $\mu$ W	632 $\Omega$ 1.3 m $\Omega$ 320 nW	200 $\Omega$ 400 $\mu$ $\Omega$ 100 nW	63.2 $\Omega$ 95 $\mu$ $\Omega$ 32 nW	20 $\Omega$ 37 $\mu$ $\Omega$ 10 nW	6.32 $\Omega$ 37 $\mu$ $\Omega$ 3.2 nW	2 $\Omega$ 40 $\mu$ $\Omega$ 1 nW	632 m $\Omega$ 38 $\mu$ $\Omega$ 320 pW	200 m $\Omega$ 40 $\mu$ $\Omega$ 100 pW	6.32 m $\Omega$ 38 $\mu$ $\Omega$ 320 pW	2 m $\Omega$ 40 $\mu$ $\Omega$ 100 pW	6.32 m $\Omega$ 37 $\mu$ $\Omega$ 32 pW	*		
	10 $\mu$ A	63.2 k $\Omega$ 63 m $\Omega$ 3.2 $\mu$ W	20 k $\Omega$ 20 m $\Omega$ 1 $\mu$ W	6.32 k $\Omega$ 6.3 m $\Omega$ 320 nW	2 k $\Omega$ 4 m $\Omega$ 100 nW	632 $\Omega$ 1.3 m $\Omega$ 32 nW	200 $\Omega$ 300 $\mu$ $\Omega$ 10 nW	63.2 $\Omega$ 120 $\mu$ $\Omega$ 3.2 nW	20 $\Omega$ 120 $\mu$ $\Omega$ 1 nW	6.32 $\Omega$ 130 $\mu$ $\Omega$ 320 pW	2 $\Omega$ 130 $\mu$ $\Omega$ 100 pW	632 m $\Omega$ 120 $\mu$ $\Omega$ 32 pW	200 m $\Omega$ 130 $\mu$ $\Omega$ 32 pW	6.32 m $\Omega$ 130 $\mu$ $\Omega$ 32 pW	200 m $\Omega$ 120 $\mu$ $\Omega$ 10 pW	*		
	3.16 $\mu$ A	200 k $\Omega$ 200 m $\Omega$ 1 $\mu$ W	63.2 k $\Omega$ 63 m $\Omega$ 320 nW	20 k $\Omega$ 20 m $\Omega$ 100 nW	6.32 k $\Omega$ 13 m $\Omega$ 32 nW	2 k $\Omega$ 4 m $\Omega$ 10 nW	632 $\Omega$ 950 $\mu$ $\Omega$ 3.2 nW	200 $\Omega$ 370 $\mu$ $\Omega$ 1 nW	63.2 $\Omega$ 370 $\mu$ $\Omega$ 320 pW	20 $\Omega$ 400 $\mu$ $\Omega$ 100 pW	6.32 $\Omega$ 380 $\mu$ $\Omega$ 32 pW	2 $\Omega$ 400 $\mu$ $\Omega$ 10 pW	632 m $\Omega$ 370 $\mu$ $\Omega$ 3.2 pW	200 m $\Omega$ 370 $\mu$ $\Omega$ 3.2 pW	632 m $\Omega$ 370 $\mu$ $\Omega$ 3.2 pW	*		
	1 $\mu$ A	632 k $\Omega$ 630 m $\Omega$ 320 nW	200 k $\Omega$ 200 m $\Omega$ 100 nW	63.2 k $\Omega$ 63 m $\Omega$ 32 nW	20 k $\Omega$ 40 m $\Omega$ 10 nW	6.32 k $\Omega$ 13 m $\Omega$ 3.2 nW	2 k $\Omega$ 3 m $\Omega$ 1 nW	632 $\Omega$ 1.2 m $\Omega$ 320 pW	200 $\Omega$ 1.2 m $\Omega$ 100 pW	63.2 $\Omega$ 1.3 m $\Omega$ 32 pW	20 $\Omega$ 1.3 m $\Omega$ 10 pW	6.32 $\Omega$ 1.3 m $\Omega$ 3.2 pW	2 $\Omega$ 1.3 m $\Omega$ 3.2 pW	2 $\Omega$ 1.2 m $\Omega$ 1 pW	2 $\Omega$ 1.2 m $\Omega$ 1 pW	*		
	316 nA	2 M $\Omega$ 2 $\Omega$ 100 nW	632 k $\Omega$ 630 m $\Omega$ 32 nW	200 k $\Omega$ 200 m $\Omega$ 10 nW	63.2 k $\Omega$ 130 m $\Omega$ 3.2 nW	20 k $\Omega$ 40 m $\Omega$ 1 nW	6.32 k $\Omega$ 13 m $\Omega$ 320 pW	2 k $\Omega$ 4 m $\Omega$ 100 pW	632 $\Omega$ 3.8 m $\Omega$ 32 pW	200 $\Omega$ 4 m $\Omega$ 10 pW	63.2 $\Omega$ 3.8 m $\Omega$ 3.2 pW	20 $\Omega$ 4 m $\Omega$ 1 pW	6.32 $\Omega$ 3.8 m $\Omega$ 3.2 pW	2 $\Omega$ 4 m $\Omega$ 1 pW	6.32 $\Omega$ 3.8 m $\Omega$ 320 fW	*		
	100 nA	6.32 M $\Omega$ ** 32 nW	2 M $\Omega$ 2 $\Omega$ 10 nW	632 k $\Omega$ 630 m $\Omega$ 3.2 nW	200 k $\Omega$ 400 m $\Omega$ 1 nW	63.2 k $\Omega$ 130 m $\Omega$ 320 pW	20 k $\Omega$ 30 m $\Omega$ 100 pW	6.32 k $\Omega$ 13 m $\Omega$ 32 pW	2 k $\Omega$ 16 [30] m $\Omega$ 10 pW	632 $\Omega$ 13 m $\Omega$ 3.2 pW	200 $\Omega$ 12 m $\Omega$ 1 pW	63.2 $\Omega$ 13 m $\Omega$ 320 fW	20 $\Omega$ 13 m $\Omega$ 320 fW	6.32 $\Omega$ 13 m $\Omega$ 320 fW	20 $\Omega$ 12 m $\Omega$ 100 fW	20 $\Omega$ 12 m $\Omega$ 100 fW	*	
	31.6 nA	20 M $\Omega$ ** 10 nW	6.32 M $\Omega$ ** 3.2 nW	2 M $\Omega$ 2 $\Omega$ 1 nW	632 k $\Omega$ 1.3 $\Omega$ 320 pW	200 k $\Omega$ 300 m $\Omega$ 100 pW	63.2 k $\Omega$ 160 m $\Omega$ 32 pW	20 k $\Omega$ 100 m $\Omega$ 10 pW	6.32 k $\Omega$ 63 [95] m $\Omega$ 3.2 pW	2 k $\Omega$ 40 m $\Omega$ 1 pW	632 $\Omega$ 38 m $\Omega$ 320 fW	200 $\Omega$ 40 m $\Omega$ 100 fW	6.32 $\Omega$ 38 m $\Omega$ 320 fW	2 $\Omega$ 40 m $\Omega$ 100 fW	6.32 $\Omega$ 38 m $\Omega$ 32 fW	6.32 $\Omega$ 38 m $\Omega$ 32 fW	*	
	10 nA	63.2 M $\Omega$ ** 3.2 nW	20 M $\Omega$ ** 1 nW	6.32 M $\Omega$ ** 320 pW	2 M $\Omega$ 3 $\Omega$ 100 pW	632 k $\Omega$ 1.6 $\Omega$ 32 pW	200 k $\Omega$ 600 m $\Omega$ 10 pW	63.2 k $\Omega$ 470 m $\Omega$ 3.2 pW	20 k $\Omega$ 300 [400] m $\Omega$ 1 pW	632 $\Omega$ 130 m $\Omega$ 320 fW	6.32 k $\Omega$ 160 m $\Omega$ 100 fW	2 k $\Omega$ 130 m $\Omega$ 32 fW	6.32 $\Omega$ 130 m $\Omega$ 32 fW	200 $\Omega$ 130 m $\Omega$ 32 fW	6.32 $\Omega$ 130 m $\Omega$ 32 fW	200 $\Omega$ 120 m $\Omega$ 10 fW	*	
	3.16 nA	*	63.2 M $\Omega$ ** 320 pW	20 M $\Omega$ ** 100 pW	6.32 M $\Omega$ ** 32 pW	2 M $\Omega$ 9 $\Omega$ 10 pW	632 k $\Omega$ 4.7 $\Omega$ 3.2 pW	200 k $\Omega$ 3 $\Omega$ 1 pW	63.2 k $\Omega$ 1.6 [1.9] $\Omega$ 320 fW	20 k $\Omega$ 1 $\Omega$ 100 fW	6.32 k $\Omega$ 1 $\Omega$ 32 fW	6.32 k $\Omega$ 630 m $\Omega$ 32 fW	2 k $\Omega$ 500 m $\Omega$ 10 fW	6.32 $\Omega$ 500 m $\Omega$ 320 aW	6.32 $\Omega$ 380 m $\Omega$ 3.2 fW	6.32 $\Omega$ 380 m $\Omega$ 3.2 fW	*	
	1 nA	*	*	63.2 M $\Omega$ ** 32 pW	20 M $\Omega$ ** 10 pW	6.32 M $\Omega$ ** 3.2 pW	2 M $\Omega$ 30 $\Omega$ 1 pW	632 k $\Omega$ 16 $\Omega$ 320 fW	200 k $\Omega$ 6 [10] $\Omega$ 100 fW	63.2 k $\Omega$ 5.1 $\Omega$ 32 fW	20 k $\Omega$ 3 $\Omega$ 10 fW	6.32 k $\Omega$ 3 $\Omega$ 3.2 fW	2 k $\Omega$ 1.3 $\Omega$ 3.2 fW	6.32 k $\Omega$ 1.3 $\Omega$ 3.2 fW	2 k $\Omega$ 1.6 $\Omega$ 1 fW	2 k $\Omega$ 1.6 $\Omega$ 1 fW	*	
316 pA	*	*	*	63.2 M $\Omega$ ** 3.2 pW	20 M $\Omega$ ** 1 pW	6.32 M $\Omega$ ** 320 fW	2 M $\Omega$ 90 $\Omega$ 100 fW	632 k $\Omega$ 47 [51] $\Omega$ 32 fW	200 k $\Omega$ 30 $\Omega$ 10 fW	63.2 k $\Omega$ 16 $\Omega$ 3.2 fW	20 k $\Omega$ 16 $\Omega$ 3.2 fW	6.32 k $\Omega$ 16 $\Omega$ 3.2 fW	20 k $\Omega$ 10 $\Omega$ 1 fW	6.32 k $\Omega$ 10 $\Omega$ 1 fW	6.32 k $\Omega$ 6.3 $\Omega$ 320 aW	6.32 k $\Omega$ 6.3 $\Omega$ 320 aW	*	
100 pA	200 k $\Omega$ — resistance range 100 $\Omega$ [150 $\Omega$ ] — measurement resolution [control resolution] 1.0 fW — power			*	63.2 M $\Omega$ ** 320 fW	20 M $\Omega$ ** 100 fW	6.32 M $\Omega$ ** 32 fW	2 M $\Omega$ 300 $\Omega$ 10 fW	632 k $\Omega$ 160 $\Omega$ 3.2 fW	6.32 k $\Omega$ 160 $\Omega$ 3.2 fW	200 k $\Omega$ 100 $\Omega$ 1 fW	6.32 k $\Omega$ 51 $\Omega$ 320 aW	200 k $\Omega$ 51 $\Omega$ 320 aW	6.32 k $\Omega$ 30 $\Omega$ 100 aW	200 k $\Omega$ 30 $\Omega$ 100 aW	200 k $\Omega$ 30 $\Omega$ 100 aW	*	
3.16 pA	Resistance range: Full scale resistance range, nominal 20% over range. Resolution: RMS noise with 18 s filter settling time (approximates 3 s analog time constant). Noise specified at 1/2 full scale resistance at room temperature. Power: Excitation power at one-half full scale resistance. Precision: Dominated by measurement temperature coefficient ( $\pm 0.0015\%$ of reading $\pm 0.0002\%$ of range)/ $^{\circ}$ C			*	*	63.2 M $\Omega$ ** 32 fW	20 M $\Omega$ ** 10 fW	6.32 M $\Omega$ ** 3.2 fW	2 M $\Omega$ 900 $\Omega$ 1 fW	6.32 k $\Omega$ 470 $\Omega$ 320 aW	6.32 k $\Omega$ 470 $\Omega$ 320 aW	200 k $\Omega$ 300 $\Omega$ 100 aW	200 k $\Omega$ 300 $\Omega$ 100 aW	6.32 k $\Omega$ 300 $\Omega$ 100 aW	6.32 k $\Omega$ 300 $\Omega$ 100 aW	6.32 k $\Omega$ 300 $\Omega$ 100 aW	*	
10 pA				*	63.2 M $\Omega$ ** 32 fW	20 M $\Omega$ ** 10 fW	6.32 M $\Omega$ ** 3.2 fW	2 M $\Omega$ ** 1 fW	6.32 k $\Omega$ ** 320 aW	6.32 k $\Omega$ ** 320 aW	2 M $\Omega$ ** 100 aW	6.32 k $\Omega$ ** 32 aW	6.32 k $\Omega$ ** 32 aW	200 k $\Omega$ ** 10 aW	200 k $\Omega$ ** 10 aW	200 k $\Omega$ ** 10 aW	*	
3.16 pA				*	*	*	*	63.2 M $\Omega$ ** 320 aW	20 M $\Omega$ ** 100 aW	6.32 M $\Omega$ ** 32 aW	2 M $\Omega$ ** 32 aW	6.32 k $\Omega$ ** 10 aW	6.32 k $\Omega$ ** 10 aW	2 M $\Omega$ ** 10 aW	6.32 k $\Omega$ ** 10 aW	6.32 k $\Omega$ ** 10 aW	*	
1 pA				*	*	*	*	*	*	63.2 M $\Omega$ ** 32 aW	20 M $\Omega$ ** 10 aW	6.32 M $\Omega$ ** 3.2 aW	2 M $\Omega$ ** 3.2 aW	6.32 k $\Omega$ ** 30 k $\Omega$	2 M $\Omega$ ** 30 k $\Omega$	2 M $\Omega$ ** 1 aW	2 M $\Omega$ ** 1 aW	*

**Accuracy**

- $\pm 0.03\% + 0.005\%$  of range
- $\pm 0.05\% + 0.008\%$  of range
- $\pm 0.1\% + 0.015\%$  of range
- $\pm 0.3\% + 0.05\%$  of range
- $\pm 0.5\% + 0.08\%$  of range
- $\pm 1.0\% + 0.15\%$  of range

\* Range not available  
\*\* Range available, not specified





372/3708 performance specification table (3708 is no longer available)

Current excitation	Voltage range							
	6.32 mV	2.0 mV	632 μV	200 μV	63.2 μV	20 μV	6.32 μV	2.0 μV
31.6 mA	200 mΩ 200 nΩ 100 μW	63.2 mΩ 63 nΩ 32 μW	20 mΩ 40 nΩ 10 μW	6.32 mΩ 13 nΩ 3.2 μW	2.0 mΩ 10 nΩ 1.0 μW	*	*	*
10 mA	632 mΩ 630 nΩ 32 μW	200 mΩ 200 nΩ 10 μW	63.2 mΩ 130 nΩ 3.2 μW	20 mΩ 40 nΩ 1.0 μW	6.32 mΩ 32 nΩ 320 nW	2.0 mΩ 32 nΩ 100 nW	*	*
3.16 mA	2.0 Ω 2.0 μΩ 10 μW	632 mΩ 630 nΩ 3.2 μW	200 mΩ 400 nΩ 1.0 μW	63.2 mΩ 130 nΩ 320 nW	20 mΩ 100 nΩ 100 nW	6.32 mΩ 100 nΩ 32 nW	2.0 mΩ 100 nΩ 10 nW	*
1 mA	6.32 Ω 6.3 μΩ 3.2 μW	2.0 Ω 2.0 μΩ 1.0 μW	632 mΩ 1.3 μΩ 320 nW	200 mΩ 400 nΩ 100 nW	63.2 mΩ 320 nΩ 32 nW	20 mΩ 320 nΩ 10 nW	6.32 mΩ 320 nΩ 3.2 nW	2.0 mΩ 320 nΩ 1.0 nW
316 μA	20 Ω 20 μΩ 1.0 μW	6.32 Ω 6.3 μΩ 320 nW	2.0 Ω 4.0 μΩ 100 nW	632 mΩ 1.3 μΩ 32 nW	200 mΩ 1.0 μΩ 10 nW	63.2 mΩ 1.0 μΩ 3.2 nW	20 mΩ 1.0 μΩ 1.0 nW	6.32 mΩ 1.0 μΩ 320 pW
100 μA	63.2 Ω 63 μΩ 320 nW	20 Ω 20 μΩ 100 nW	6.32 Ω 13 μΩ 32 nW	2.0 Ω 4.0 μΩ 10 nW	632 mΩ 3.2 μΩ 3.2 nW	200 mΩ 3.2 μΩ 1.0 nW	63.2 mΩ 3.2 μΩ 320 pW	20 mΩ 3.2 μΩ 100 pW
31.6 μA	200 Ω 200 μΩ 100 nW	63.2 Ω 63 μΩ 32 nW	20 Ω 40 μΩ 10 nW	6.32 Ω 13 μΩ 3.2 nW	2.0 Ω 10 μΩ 1.0 nW	632 mΩ 10 μΩ 320 pW	200 mΩ 10 μΩ 100 pW	63.2 mΩ 10 μΩ 32 pW
10 μA	632 Ω 630 μΩ 32 nW	200 Ω 200 μΩ 10 nW	63.2 Ω 130 μΩ 3.2 nW	20 Ω 40 μΩ 1.0 nW	6.32 Ω 32 μΩ 320 pW	2.0 Ω 32 μΩ 100 pW	632 mΩ 32 μΩ 32 pW	200 mΩ 32 μΩ 10 pW
3.16 μA	2.0 kΩ 2.0 mΩ 10 nW	632 Ω 630 μΩ 3.2 nW	200 Ω 400 μΩ 1.0 nW	63.2 Ω 130 μΩ 320 pW	20 Ω 100 μΩ 100 pW	6.32 Ω 100 μΩ 32 pW	2.0 Ω 100 μΩ 10 pW	632 mΩ 100 μΩ 3.2 pW
1 μA	6.32 kΩ 6.3 mΩ 3.2 nW	2.0 kΩ 2.0 mΩ 1.0 nW	632 Ω 1.3 mΩ 320 pW	200 Ω 400 μΩ 100 pW	63.2 Ω 320 μΩ 32 pW	20 Ω 320 μΩ 10 pW	6.32 Ω 320 μΩ 3.2 pW	2.0 Ω 320 μΩ 1.0 pW
316 nA	20 kΩ 20 mΩ 1.0 nW	6.32 kΩ 6.3 mΩ 320 pW	2.0 kΩ 4.0 mΩ 100 pW	632 Ω 1.3 mΩ 32 pW	200 Ω 1.0 mΩ 10 pW	63.2 Ω 1.0 mΩ 3.2 pW	20 Ω 1.0 mΩ 1.0 pW	6.32 Ω 1.0 mΩ 320 fW
100 nA	63.2 kΩ 63 mΩ 320 pW	20 kΩ 40 mΩ 100 pW	6.32 kΩ 13 mΩ 32 pW	2.0 kΩ 6.0 mΩ 10 pW	632 Ω 3.2 mΩ 3.2 pW	200 Ω 3.2 mΩ 1.0 pW	63.2 Ω 3.2 mΩ 320 fW	20 Ω 3.2 mΩ 100 fW
31.6 nA	200 kΩ 400 mΩ 100 pW	63.2 kΩ 130 mΩ 32 pW	20 kΩ 60 mΩ 10 pW	6.32 kΩ 20 mΩ 3.2 pW	2.0 kΩ 20 mΩ 1.0 pW	632 Ω 10 mΩ 320 fW	200 Ω 10 mΩ 100 fW	63.2 Ω 10 mΩ 32 fW
10 nA	632 kΩ 1.9 Ω 32 pW	200 kΩ 600 mΩ 10 pW	63.2 kΩ 200 mΩ 3.2 pW	20 kΩ 200 mΩ 1.0 pW	6.32 kΩ 63 mΩ 320 fW	2.0 kΩ 63 mΩ 100 fW	632 Ω 32 Ω 32 fW	200 Ω 32 mΩ 10 fW
3.16 nA	2.0 MΩ 6.0 Ω 10 pW	632 kΩ 2.0 Ω 3.2 pW	200 kΩ 2.0 Ω 1.0 pW	63.2 kΩ 630 mΩ 320 fW	20 kΩ 600 mΩ 100 fW	6.32 kΩ 200 mΩ 32 fW	2.0 kΩ 200 mΩ 10 fW	632 Ω 100 mΩ 3.2 fW
1 nA	6.32 MΩ ** 3.2 pW	2.0 MΩ 20 Ω 1.0 pW	632 kΩ 6.3 Ω 320 fW	200 kΩ 6.0 Ω 100 fW	63.2 kΩ 3.2 Ω 32 fW	20 kΩ 2.0 Ω 10 fW	6.32 kΩ 630 mΩ 3.2 fW	2.0 kΩ 1.0 Ω 1.0 fW
316 pA	*	6.32 MΩ ** 320 fW	2.0 MΩ 60 Ω 100 fW	632 kΩ 19 Ω 32 fW	200 kΩ 20 Ω 10 fW	63.2 kΩ 6.3 Ω 3.2 fW	20 kΩ 3.0 Ω 1.0 fW	6.32 kΩ 3.2 Ω 320 aW
100 pA	*	*	6.32 MΩ ** 32 fW	2.0 MΩ 200 Ω 10 fW	632 kΩ 63 Ω 3.2 fW	200 kΩ 60 Ω 1.0 fW	63.2 kΩ 32 Ω 320 aW	20 kΩ 20 Ω 100 aW
31.6 pA	*	*	*	6.32 MΩ ** 3.2 fW	2.0 MΩ 600 Ω 1.0 fW	632 kΩ 190 Ω 320 aW	200 kΩ 200 Ω 100 aW	63.2 kΩ 63 Ω 32 aW
10 pA	*	*	*	*	6.32 MΩ ** 320 aW	2.0 MΩ 2.0 kΩ 100 aW	632 kΩ 630 Ω 32 aW	200 kΩ 600 Ω 10 aW
3.16 pA	*	*	*	*	*	6.32 MΩ ** 32 aW	2.0 MΩ 6.0 kΩ 10 aW	632 kΩ 1.9 kΩ 3.2 aW

200 kΩ — resistance range  
100 Ω — measurement resolution  
1.0 fW — power

**Resistance range:** Full scale resistance range, nominal 20% over range.

**Resolution:** RMS noise with 18 s filter settling time (approximates 3 s analog time constant). Noise specified at ½ full scale resistance at room temperature.

**Power:** Excitation power at one-half full scale resistance.

**Precision:** Dominated by measurement temperature coefficient (±0.0015% of reading ±0.0002% of range)/°C.

**Accuracy**

- ±0.03% + 0.005% of range
- ±0.05% + 0.008% of range
- ±0.1% + 0.015% of range
- ±0.3% + 0.05% of range
- ±0.5% + 0.08% of range
- ±1.0% + 0.15% of range

\* Range not available  
\*\* Range available, not specified



## Specifications

### Measurement input

Input type	AC, four-lead differential, resistance
Number of inputs	1
Maximum channels	16 (with optional scanner)
Measurement units	$\Omega$ , K (with temperature curve)
Resistance ranges	22 ranges from 2 m $\Omega$ to 63.2 M $\Omega$ (excitation dependent)
Maximum update rate	10 rdg/s (single range and input)
Range change settling	3 s + filter settling
Channel change (scan) settling	3 s + filter settling
Resolution	Sensor and range dependent, refer to Measurement Input Specifications table
Accuracy	Sensor and range dependent, refer to Measurement Input Specifications table
Temperature coefficient	$\pm 0.0015\%/^{\circ}\text{C}$ of rdg
Maximum lead resistance	100 $\Omega$ + 10% of resistance range per lead for current $\leq 3.16$ mA; 10 $\Omega$ + 10% of resistance range per lead for current $\geq 10$ mA
Isolation	Isolated from chassis and heater grounds
Lead connections	V+, V-, I+, I-, V shield, I shield, individual guards
Scanner lead connections	V+, V-, I+, I-, for each sensor, shield common to all
Common mode rejection	Matched impedance voltage input and current output, active CMR
Excitation	Sinusoidal AC current source
Excitation frequency	9.8 Hz, 11.6 Hz, 13.7 Hz (default), 16.2 Hz, or 18.2 Hz
Excitation currents	22 ranges from 1 pA to 31.6 mA RMS
Excitation accuracy	$\pm 2\%$ of nominal
Minimum excitation power	$10^{-18}$ W into a 100 k $\Omega$ (see Measurement Input Specifications table for other ranges)
Typical DC bias current	2 pA + 1% of excitation current ( $4.0 \times 10^{-19}$ W into 100 k $\Omega$ )
Maximum DC bias current	4 pA + 1% of excitation current ( $1.6 \times 10^{-18}$ W into 100 k $\Omega$ )
Power up current protection	Current output shunted on power up
Voltage input ranges	12 ranges from 2 $\mu\text{V}$ to 632 mV RMS
Voltage input over-range	20%
Voltage input impedance	$> 5 \times 10^{13}$ $\Omega$
Maximum input voltage noise	10 nV/ $\sqrt{\text{Hz}}$ at 10 Hz
Range selection modes	Manual, voltage excitation, current excitation, autorange
Scanner modes	Manual or autoscan
Filter	1 s to 200 s settling time, 1% to 80% filter window
Additional software features	Min/Max reading capture, pause (3 s to 60 s) on range and/or channel change, scanner dwell time (1 s to 200 s)
Supported temperature sensors	NTC resistive sensors including germanium, Cernox <sup>®</sup> , Rox <sup>™</sup> , PTC resistive sensors including rhodium-iron
Quadrature display	Real and Imaginary
Connectors	6-pin DIN (current out), 6-pin DIN (voltage in), and DA-15 (scanner control)
Supported scanners	Lake Shore 3726 and 3708 (3708 is no longer available)

### Control input

Input type	AC, four-lead differential, resistance
Number of inputs	1
Measurement units	$\Omega$ , K (with temperature curve)
Resistance ranges	6 ranges from 2 k $\Omega$ to 632 k $\Omega$ (excitation dependent)
Maximum update rate	10 rdg/s (single range)
Range change settling	3 s + filter settling
Resolution	Sensor and range dependent, refer to Control Input Specifications table
Accuracy	Sensor and range dependent, refer to Control Input Specifications table
Temperature coefficient	$\pm 0.0015\%/^{\circ}\text{C}$ of reading
Maximum lead resistance	100 $\Omega$ + 10% of resistance range per lead
Isolation	Isolated from chassis, common to measurement input

Lead connections	V+, V-, I+, I-, shield
Common mode rejection	Matched impedance voltage input and current output
Excitation	Sinusoidal AC current source
Excitation frequency	9.8 Hz, 11.6 Hz, 13.7 Hz, 16.2 Hz (default), or 18.2 Hz
Excitation currents	6 ranges from 316 pA to 100 nA RMS
Excitation accuracy	$\pm 8\%$ of nominal for 316 pA and 1 nA ranges; $\pm 2\%$ of nominal for the other ranges
Power up current protection	Current output shunted on power up
Voltage input range	200 $\mu\text{V}$
Voltage input over-range	20%
Maximum input voltage noise	20 nV/ $\sqrt{\text{Hz}}$ at 10 Hz
Range selection modes	Manual, standard autorange, and Rox <sup>™</sup> RX-102B-CB optimized autorange
Filter	1 s to 200 s settling time, 1% to 80% filter window
Additional software features	Min/Max reading capture
Supported sensors	NTC resistive sensors (optimized for Rox <sup>™</sup> RX-102B-CB sensor)
Minimum temperature	Down to 10 mK using a Rox <sup>™</sup> RX-102B-CB sensor in a well-designed system
Connector	6-pin DIN

### Temperature conversion

Sensor temperature coefficient	Negative or positive
User curves	Up to 39 CalCurves <sup>™</sup> or user curves (200-point)
Curve entry	Via front panel or computer interface
Curve format	$\Omega/\text{K}$ , Log $\Omega/\text{K}$
Curve interpolation	Cubic spline, linear

### Sample heater output

Type	Variable DC current source
Control modes	Closed loop PID, PID zones, open loop
Setpoint units	$\Omega$ , K (with temperature curve)
D/A resolution	16-bit
Ranges	100 mA, 31.6 mA, 10 mA, 3.16 mA, 1 mA, 316 $\mu\text{A}$ , 100 $\mu\text{A}$ , 31.6 $\mu\text{A}$
Output compliance voltage (min)	$\pm 10$ V
Maximum power of output ranges	1 W, 100 mW, 10 mW, 1 mW, 100 $\mu\text{W}$ , 10 $\mu\text{W}$ , 1 $\mu\text{W}$ , 0.1 $\mu\text{W}$
Resistance range	1 $\Omega$ to 2 k $\Omega$ , 100 $\Omega$ for maximum power
Heater offset (at 0%)	$\pm 0.02\%$ of range
Heater gain accuracy	$\pm 1\%$ of setting
Heater noise	$< 0.005\%$ of range
Isolation	Isolated from chassis ground, measurement and control inputs; shared ground with analog/still output
Heater connector	Detachable terminal block
Safety limits	Curve temperature, power up heater off, shunted with a relay on power up, short-circuit protection, compliance voltage limit detection, input temperature limit
Additional software features	Heater power display based on user entered resistance

### Warm-up heater output

Type	Variable DC current source	
Control modes	Closed loop PID, PID zones, open loop, warm-up mode	
Setpoint units	$\Omega$ , K (with temperature curve)	
D/A resolution	16-bit	
Maximum power	<b>25 <math>\Omega</math> setting</b> 10 W	<b>50 <math>\Omega</math> setting</b> 10 W
Maximum current	0.63 A	0.45 A
Voltage compliance (min)	+15.8 V	+22.4 V
Heater load for maximum power	25 $\Omega$	50 $\Omega$
Resistance range	10 $\Omega$ to 100 $\Omega$	
Isolation	Chassis ground reference	
Heater connector	Detachable terminal block	
Safety limits	Curve temperature, power up heater off, shunted with a relay on power up, short-circuit protection, compliance voltage limit, relay disconnects output when off, input temperature limit	



## Analog/still output

Type	Variable DC voltage source
Control modes	Open loop, still heater, monitor output
Isolation	Isolated from chassis ground, measurement and control inputs; shared ground with sample heater
Output voltage range	±10 V
Maximum current	100 mA
Maximum power	1 W into 100 Ω
Minimum load resistance	100 Ω (short-circuit protected)
Accuracy	±2.5 mV
Noise (resolution)	<0.003% of range
Monitor output settings	
Scale	User selected
Data source	Temperature or sensor units
Settings	Input, source, top of scale, and bottom of scale
Connector	Detachable terminal block

## Heater control

Number of control loops	2 (sample heater, warm-up heater)
Update rate	10/s
Tuning	Manual PID, zone
PID control settings	
Proportional (gain)	0.0 to 1,000
Integral (reset)	0 to 10,000 s
Derivative (rate)	0 to 2,500 s
Manual output	0 to 100% with 0.01% setting resolution
Zone control	10 temperature zones with P, I, D, manual heater out, heater range, setpoint, relays, and analog output (still)
Setpoint ramping	0.001 K/min to 100 K/min
Scanner support	Control with scanned channel (reduced stability)
Control stability	Below 10 µK peak-to-peak at 50 mK (system dependent)
Warm-up heater mode settings	
Warm-up percentage	0 to 100% with 1% resolution
Warm-up mode	Continuous control or auto-off

## Front panel

Display	8-line by 40-character (256 × 64 pixel) graphic VF display module
Number of reading displays	1 to 8
Display units	mK, K, mΩ, Ω, kΩ, MΩ
Reading source	Resistance, temperature, max, min
Display update rate	2 rdg/s
Other displays	Input name, channel number, resistance range, excitation voltage, excitation current, excitation power, control setpoint, PID, heater range, heater output, and quadrature reading
Setpoint setting resolution	Same as display resolution (sensor-dependent)
Heater output display	Numeric display in percent of full scale for power or current
Display annunciators	Control input and alarm
LED annunciators	Autorange, excitation mode, autoscan, control outputs, remote, Ethernet status, alarm, still output
Keypad	34-key silicone elastomer keypad
Front panel features	Front panel curve entry, and keypad lock-out

## Interface

IEEE-488.2	
Capabilities	SH1, AH1, T5, L4, SR1, RL1, PP0, DC1, DT0, C0, E1
Update rate	To 10 rdg/s on each input
Software support	LabVIEW™ driver (see www.lakeshore.com)
USB	
Function	Emulates a standard RS-232 serial port
Baud rate	57,600
Connector	B-type USB connector
Update rate	To 10 rdg/s on each input
Software support	LabVIEW™ driver (see www.lakeshore.com)
Ethernet	
Function	TCP/IP, web interface, curve handler, configuration backup, chart recorder
Connector	RJ-45
Update rate	To 10 rdg/s on each input
Software support	LabVIEW™ driver (see www.lakeshore.com)
Special interface feature	Model 370 command emulation mode
Available baud rates	300, 1,200, 9,600, 57,600
Alarms	
Number	34, high and low for each measurement channel and the control input
Data source	Temperature or sensor units
Settings	Source, high setpoint, low setpoint, deadband, latching or non-latching, audible on/off, visible on/off
Actuators	Display annunciator, beeper, and relays
Relays	
Number	2
Contacts	Normally open (NO), normally closed (NC), and common (C)
Contact rating	30 VDC at 2 A
Operation	Activate relays on high, low, or both alarms for any measurement channel or control input, manual mode, or zone control mode
Connector	Detachable terminal block monitor output
Diagnostic monitor output	
Operation	User selects one of several analog voltage diagnostic points (must remain isolated)
Available signals	1. AC voltage driving positive/negative side of current source programming resistor 2. AC voltage present on the positive/negative side of the differential input amplifier 3. AC voltage present on the output of the differential input amplifier 4. AC voltage into the measurement channel or control input AD converter
Connector	BNC
Reference output	
Signal type	Phase-sensitive detector reference (must remain isolated)
Amplitude	0 to +5 V nominal
Waveform	Square wave
Connector	BNC

## General

Ambient temperature	15 °C to 35 °C at rated accuracy; 5 °C to 40 °C at reduced accuracy
Power requirement	100, 120, 220, 240 VAC, ±10%, 50 or 60 Hz, 90 VA
Size	435 mm W × 89 mm H × 368 mm D (17 in × 3.5 in × 14.5 in), full rack
Weight	6.8 kg (15 lb)
Approval	CE mark, RoHS
Scanner size	135 mm W × 66 mm H × 157 mm D (5.3 in × 2.6 in × 6.2 in), plus connector clearance of 125 mm (5 in)



## Ordering information

### Part number Description

<b>372N</b>	AC resistance bridge and temperature controller with no connection cable
<b>372S</b>	AC resistance bridge with 3726 scanner and standard 3 m (10 ft) connection cable
<b>372S-6</b>	AC resistance bridge with 3726 scanner and 6 m (20 ft) connection cable
<b>372S-10</b>	AC resistance bridge with 3726 scanner and 10 m (33 ft) connection cable

### Please indicate your power/cord configuration:

- 1 100 V—U.S. cord (NEMA 5-15)
- 2 120 V—U.S. cord (NEMA 5-15)
- 3 220 V—Euro cord (CEE 7/7)
- 4 240 V—Euro cord (CEE 7/7)
- 5 240 V—U.K. cord (BS 1363)
- 6 240 V—Swiss cord (SEV 1011)
- 7 220 V—China cord (GB 1002)

### Scanners

<b>3726</b>	16-channel scanner with standard 3 m (10 ft) connection cable (Model 372 only)
<b>3726-6</b>	16-channel scanner with 6 m (20 ft) connection cable (Model 372 only)
<b>3726-10</b>	16-channel scanner with 6 m (20 ft) connection cable (Model 372 only)

### Accessories/options

<b>106-765</b>	Terminal block, 7-pin, qty. 1
<b>107-379</b>	3726 mounting bracket
<b>117-071</b>	372 heater adapter cable
<b>COC-INS</b>	Certificate of conformance—instrument (per certificate)
<b>G-106-233</b>	Sensor input mating connector (6-pin DIN plug)
<b>G-106-253</b>	Sensor mating connector, DB-25 D-style plug, qty. 1
<b>G-106-264</b>	Shell for sensor mating connector, DB-25 D-style, qty. 1
<b>G-106-737</b>	Terminal block, 6-pin, qty. 1
<b>G-112-374</b>	3 m (10 ft) AC resistance bridge cable
<b>G-112-375</b>	6 m (20 ft) AC resistance bridge cable
<b>G-112-376</b>	10 m (33 ft) AC resistance bridge cable
<b>RM-1</b>	Kit for mounting one full rack instrument in a 482.6 mm (19 in) rack mount cabinet
<b>CAL-372-CERT</b>	Instrument recalibration with certificate
<b>CAL-372-DATA</b>	Instrument recalibration with certificate and data
<b>119-372</b>	Model 372 user manual

All specifications are subject to change without notice





# Model 350 Temperature Controller



## Model 350 features

- Ideal for use with He-3 systems and other ultra-low temperature refrigeration platforms down to 100 mK
- Optimized performance with Cernox® RTDs
- Patented low-noise input circuitry enables super low excitation power for minimal self-heating and high resolution measurement
- 4 independent control loops and a broad range of I/O configurations can eliminate need for additional instrumentation
- 4 PID-controlled outputs: 75 W warm-up heater, 1 W sample heater, and 2 auxiliary 1 W  $\pm 10$  V outputs
- Proven, intuitive interface
- Performance assurance even at the extremes, with verifiable product specifications
- CE certification
- Full 3 year standard warranty





### A powerful ultra-low temperature physics tool

The Model 350 is designed for the demands of pumped He-3 refrigerators and other ultra-low and low temperature platforms. It provides excellent measurement performance, superior control accuracy, and convenient operation in a wide range of advanced research applications. Whether the need is for high accuracy with minimal thermal impact, or precise temperature control in high magnetic fields, or dependable measurement in radiation environments, the new Model 350 controller matched with Lake Shore's industry-leading Cernox® sensors provides a cryogenic solution that's demonstrably best-in-class.



The patented noise reduction input circuitry of the Model 350 is just one reason why this controller works so well for ultra-low temperature (ULT) applications, all the way down to 100 mK. When combined with precision Cernox sensors, this performance-optimized design allows as little as 10 nA of excitation current to be used, minimizing self-heating effects, and ensures best possible measurement accuracy throughout the entire temperature range.

This single instrument offers extraordinary capability and flexibility, often eliminating the need for additional instrumentation in a refrigeration control system. Its four input channels and four independent control outputs are configurable to support a broad range of I/O requirements, including the heaters and auxiliary devices typical of ULT refrigeration systems, as well as other cryogenic sensor types like ruthenium oxide and platinum RTDs. Standard computer interfaces enable remote communications, control and coordination with other systems.

In short, the Model 350 cryogenic temperature controller brings a new level of power, precision, and performance to critical low temperature physics research. It is ideal for use with He-3 systems, adiabatic demagnetization refrigerators (ADRs), certain dilution refrigerators, and many other applications demanding low thermal power and high measurement precision.

### 4 standard sensor input channels

The Model 350 comes with four standard sensor inputs supporting Cernox®, ruthenium oxide, platinum RTDs, and other NTC RTD sensors. Inputs can be configured to accept any of the supported input types. Each sensor input channel has its own current source, providing fast settling times. The four sensor inputs are optically isolated from other circuits to reduce noise and to provide repeatable sensor measurements. Current reversal eliminates thermal electromotive force (EMF) errors in resistance sensors. Nine excitation currents facilitate temperature measurement and control down to 100 mK, with the nominal temperature range (using Cernox® sensors) spanning to 420 K. The instrument automatically selects the optimal current and gain levels for you once the sensor type is selected, and automatically scales current to minimize self-heating effects at low temperatures. The patented input circuitry eliminates any errors associated with grounding inconsistencies, making it easier to achieve reliable measurements at ultra-low temperatures. With the ability to label each sensor input channel with a customized name, it's also easy to identify the measured values being displayed.

### Application versatility

Designed to support a broad range of sensor types, the Model 350 is performance-optimized for use over the entire temperature range of Cernox® sensors, making it the instrument of choice for ULT environments as well as other cryogenic systems where errors due to magneto-resistive or radiation effects need to be minimized.



### 3 option cards for more inputs and a wider range of applications

Field installable input option cards can expand your sensor selection to include silicon diodes (like DT-670), capacitance sensors or thermocouples. Once installed, the option input can be selected and named from the front panel like any other input type. These option cards further expand the application versatility of the Model 350 temperature controller by allowing specialized sensors to be switched in and out to achieve specific measurement objectives. For example, addition of the thermocouple input option enables continuous measurement to 1000 K and above. Alternatively, the capacitance sensor option card enables a magnetics-impervious capacitance temperature sensor to be temporarily switched in for elimination of magneto-resistive effects while taking low temperature sample measurements under high or changing fields. Diode sensor support is provided by the 4-channel expansion card, which also enables use of additional Cernox® sensors for supplemental monitoring.



#### 4 PID controlled outputs

For convenient integration into a wide range of systems, the Model 350 offers four PID-controlled outputs. Variable DC current source outputs include a 75 W output for direct control of the typical main warm-up heater, and a 1 W output for fine control of the sample heater. Two additional 1 W variable DC voltage source outputs can be used to power auxiliary devices like a still heater in a dilution refrigerator, or to control a magnet power supply driving an ADR. The ability to dynamically select an input to associate with the controlled output provides additional flexibility in setting up the control scheme.

#### Precision temperature control

The Model 350 calculates the precise control output based on your temperature setpoint and feedback from the control sensor. You can manually set the PID values for fine control, or the temperature control loop autotuning feature can automate the tuning process for you. The setpoint ramp feature provides smooth, continuous setpoint changes and predictable setpoint approaches without the worry of overshoot or excessive settling times. When combined with the zone setting feature, which enables automatic switching of sensor inputs and scales current excitation through ten different preloaded temperature zones, the Model 350 provides continuous measurement and control over the entire temperature range required.

#### Simple and increased productivity

With remote control and automated features, the Model 350 will simplify your temperature control processes and increase your productivity in the laboratory.

#### 3 interfaces for remote control

The Model 350 temperature controller includes Ethernet, USB, and IEEE-488 interfaces. In addition to gathering data, nearly every function of the instrument can be controlled through a computer interface. Ethernet provides the ability to access and monitor instrument activities via the internet from anywhere in the world, allowing distributed sharing of the controller and the controlled system. You can download the Lake Shore curve handler software to your computer to easily enter and manipulate sensor calibration curves for storage in the instrument's non-volatile flash memory.

#### Simple automation

Each sensor input has a high and low alarm that offer latching and non-latching operation. The two relays can be used in conjunction with the alarms to alert you of a fault condition and perform simple on/off control. Relays can be assigned to any alarm or operated manually. Choosing appropriate PID control settings for a closed loop system can be tedious, but the Model 350 provides the temperature control loop autotuning feature to simplify the process. It's an automated

process that measures system characteristics and computes setting values for P, I, and D for you. Once PID tuning parameters are chosen for a given setpoint, the zone tuning feature automatically switches sensor inputs for new setpoints, enabling you to control temperatures from 100 mK to over 1000 K without interrupting your experiment.

#### Performance you can count on

As with all Lake Shore products, the Model 350 product specifications are documented and verifiable in keeping with Lake Shore's tradition of performance assurance even at application extremes. The product is supported by a 3-year standard warranty, our confirmation of quality and commitment for the long term. Choosing the Model 350 for your ultra-low temperature application means you'll have the ultimate confidence in meeting your integration, measurement and control needs, now and into the future.

#### Use additional input types with option cards

The field installable input option cards add additional input types. The Model 3060 adds thermocouple capability. The Model 3061 adds capacitance sensor inputs. The Model 3062 adds 4 Cernox®/diode inputs. While the option cards can be easily removed, it is not necessary as the standard inputs remain functional when the options are not being used.

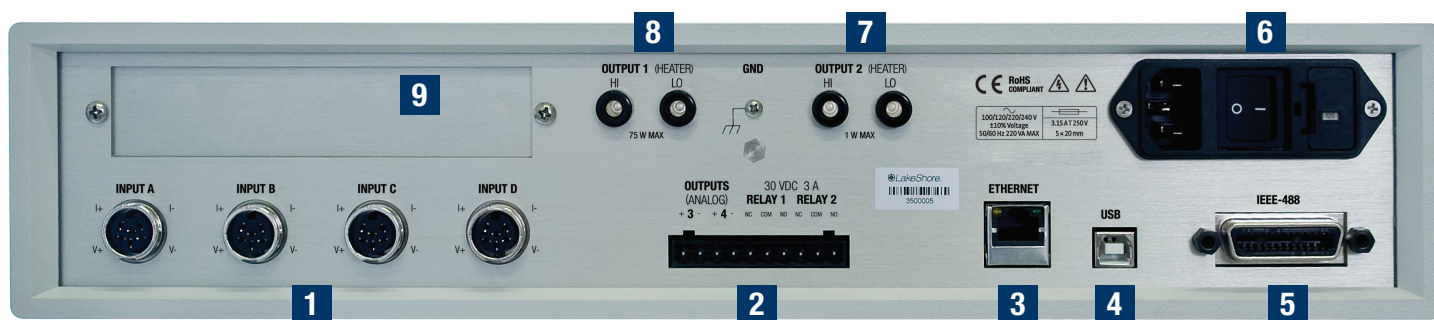

#### Model 350 rear panel

- |   |                       |                    |
|---|-----------------------|--------------------|
| 1 Sensor inputs                             | 4 USB interface       | 7 Output 2 heater  |
| 2 Terminal block (analog output and relays) | 5 IEEE-488 interface  | 8 Output 1 heater  |
| 3 Ethernet interface                        | 6 Line input assembly | 9 Option card slot |



### Configurable display

The Model 350 offers a bright, graphic liquid crystal display with an LED backlight that simultaneously displays up to eight readings. You can show all four loops, all inputs, or if you need to monitor one input, you can display just that one in greater detail. Or you can custom configure each display location to suit your experiment. Data from any input can be assigned to any of the locations, and your choice of temperature or sensor units can be displayed. For added convenience, you can also custom label each sensor input, eliminating the guesswork in remembering or determining the location to which a sensor input is associated.



#### Four input/output display with labels

Standard display option featuring all four inputs and associated outputs.



#### Two input/output display with labels

Reading locations can be user configured to meet application needs. Here, the input name is shown above each measurement reading along with the designated input letter.

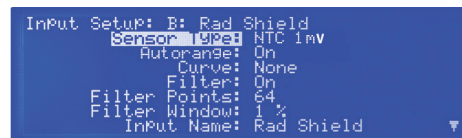

#### Intuitive menu structure

Logical navigation allows you to spend more time on research and less time on setup.

## Sensor selection

### Sensor temperature range (sensors sold separately)

		Model	Useful range	Magnetic field use
<b>Negative temperature coefficient RTDs</b>	Cernox®	CX-1010-HT	0.1 K to 420 K <sup>1,2</sup>	T > 2 K & B ≤ 19 T
	Cernox®	CX-1030-HT	0.3 K to 420 K <sup>1,2</sup>	T > 2 K & B ≤ 19 T
	Cernox®	CX-1050-HT	1.4 K to 420 K <sup>1</sup>	T > 2 K & B ≤ 19 T
	Cernox®	CX-1070-HT	4 K to 420 K <sup>1</sup>	T > 2 K & B ≤ 19 T
	Cernox®	CX-1080-HT	20 K to 420 K <sup>1</sup>	T > 2 K & B ≤ 19 T
	Germanium	GR-300-AA	0.3 K to 100 K	Not recommended
	Germanium	GR-1400-AA	1.4 K to 100 K	Not recommended
	Rox™	RX-102B	0.1 K to 40 K <sup>2</sup>	T > 2 K & B ≤ 10 T
	Rox™	RX-103	1.4 K to 40 K	T > 2 K & B ≤ 10 T
Rox™	RX-202	0.1 K to 40 K <sup>2</sup>	T > 2 K & B ≤ 10 T	
<b>Positive temperature coefficient RTDs</b>	100 Ω platinum	PT-102/3	14 K to 873 K	T > 40 K & B ≤ 2.5 T
	100 Ω platinum	PT-111	14 K to 673 K	T > 40 K & B ≤ 2.5 T
<b>Diodes</b> <i>Option—3062</i>	Silicon diode	DT-670-SD	1.4 K to 500 K	T ≥ 60 K & B ≤ 3 T
	Silicon diode	DT-670E-BR	30 K to 500 K	T ≥ 60 K & B ≤ 3 T
	Silicon diode	DT-414	1.4 K to 375 K	T ≥ 60 K & B ≤ 3 T
	Silicon diode	DT-421	1.4 K to 325 K	T ≥ 60 K & B ≤ 3 T
	Silicon diode	DT-470-SD	1.4 K to 500 K	T ≥ 60 K & B ≤ 3 T
	Silicon diode	DT-471-SD	10 K to 500 K	T ≥ 60 K & B ≤ 3 T
<b>Capacitance</b> <i>Option—3061</i>		CS-501	1.4 K to 290 K	T > 4.2 K & B ≤ 18.7 T
<b>Thermocouples</b> <i>Option—3060</i>	Type K	9006-006	3.2 K to 1505 K	Not recommended
	Type E	9006-004	3.2 K to 934 K	Not recommended

<sup>1</sup> Non-HT version maximum temperature: 325 K

<sup>2</sup> Low temperature specified with self-heating error: ≤ 5 mK

**Cernox®** thin-film RTDs offer high sensitivity and low magnetic field-induced errors over the 0.1 K to 420 K temperature range. Cernox sensors require calibration.

**Platinum RTDs** offer high uniform sensitivity from 30 K to over 800 K. With excellent reproducibility, they are useful as thermometry standards. They follow a standard curve above 70 K and are interchangeable in many applications.

**Silicon diodes** are the best choice for general cryogenic use from 1.4 K to above room temperature. Silicon diodes are economical to use because they follow a standard curve and are interchangeable in many applications. They are not suitable for use in ionizing radiation or magnetic fields.

**Capacitance** sensors are ideally suited for use in strong magnetic fields because they exhibit virtually no magnetic field dependence. They can be used from 1.4 K to 290 K.





## Typical sensor performance—see Appendix F for sample calculations of typical sensor performance

	Example Lake Shore sensor	Temperature (K)	Nominal resistance/voltage	Typical sensor sensitivity <sup>3</sup>	Measurement resolution: temperature equivalents	Electronic accuracy: temperature equivalents	Temperature accuracy including electronic accuracy, CalCurve™, and calibrated sensor	Electronic control stability <sup>4</sup> : temperature equivalents
<b>Cernox®</b> (1 mV)	CX-1010-SD with 0.1L calibration	0.1	21389 Ω	-558110 Ω/K	5.4 μK	±69 μK	±3.1 mK	±10.8 μK
		0.3	2322.4 Ω	-10785 Ω/K	28 μK	±272 μK	±3.8 mK	±56.0 μK
		0.5	1248.2 Ω	-2665.2 Ω/K	113 μK	±938 μK	±5.4 mK	±225 μK
		4.2	277.32 Ω	-32.209 Ω/K	931 μK	±6.5 mK	±11.5 mK	±1.9 mK
		300	30.392 Ω	-0.0654 Ω/K	153 mK	±1.7 K	±1.8 K	±306 mK
<b>Cernox®</b> (10 mV)	CX-1050-SD-HT <sup>5</sup> with 1.4M calibration	1.4	26566 Ω	-48449 Ω/K	6.2 μK	±261 μK	±5.3 mK	±12.4 μK
		4.2	3507.2 Ω	-1120.8 Ω/K	89 μK	±2.1 mK	±7.1 mK	±178 μK
		77	205.67 Ω	-2.4116 Ω/K	1.2 mK	±38 mK	±54 mK	±2.4 mK
		420	45.03 Ω	-0.0829 Ω/K	12 mK	±338 mK	±378 mK	±24 mK
<b>Germanium</b> (1 mV)	GR-50-AA with 0.05A calibration	0.1	2317 Ω	-71858 Ω/K	4.2 μK	±14 μK	±3.2 mK	±8.4 μK
		0.3	164 Ω	-964 Ω/K	31.1 μK	±78 μK	±3.8 mK	±62.2 μK
		0.5	73.8 Ω	-202.9 Ω/K	49.3 μK	±195 μK	±4.5 mK	±98.6 μK
		1.4	24.7 Ω	-13.15 Ω/K	228 μK	±904 μK	±4.9 mK	±456 μK
		4.2	13.7 Ω	-1.036 Ω/K	2.9 mK	±7.2 mK	±11 mK	±5.8 mK
<b>Germanium</b> (10 mV)	GR-300-AA with 0.3D calibration	0.3	35180 Ω	-512200 Ω/K	2 μK	±47 μK	±3.7 mK	±4.0 μK
		1.4	448.6 Ω	-581.3 Ω/K	17 μK	±481 μK	±4.5 mK	±34 μK
		4.2	94.46 Ω	-26.56 Ω/K	38 μK	±1.8 mK	±5.8 mK	±76 μK
		100	2.72 Ω	-0.024 Ω/K	4.2 mK	±151 mK	±181 mK	±8.4 mK
<b>Germanium</b> (10 mV)	GR-1400-AA with 1.4D calibration	1.4	35890 Ω	-94790 Ω/K	11 μK	±257 μK	±4.3 mK	±21.1 μK
		4.2	1689 Ω	-861.9 Ω/K	35 μK	±900 μK	±4.9 mK	±69.6 μK
		77	3.55 Ω	-0.05 Ω/K	2 mK	±83 mK	±99 mK	±4 mK
		100	2.8 Ω	-0.021 Ω/K	4.8 mK	±175 mK	±191 mK	±9.5 mK
<b>Rox™</b> (1 mV)	RX-102B-CB with 0.02C calibration	0.1	3549 Ω	-12578 Ω/K	79.5 μK	±908 μK	±3.8 mK	±159 μK
		0.5	2188 Ω	-1056 Ω/K	284 μK	±2.7 mK	±5.7 mK	±568 μK
		1.4	1779 Ω	-198 Ω/K	1.5 mK	±13.7 mK	±18.7 mK	±3.0 mK
		4.2	1546 Ω	-40.0 Ω/K	7.5 mK	±65.4 mK	±81.4 mK	±15.0 mK
		40	1199 Ω	-3.41 Ω/K	88 mK	±727 mK	±764 mK	±176 mK
<b>Platinum RTD</b> 500 Ω full scale	PT-103 with 14J calibration	30	3.66 Ω	0.191 Ω/K	0.5 mK	±22 mK	±32 mK	±1.0 mK
		77	20.38 Ω	0.423 Ω/K	0.7 mK	±34 mK	±46 mK	±1.4 mK
		300	110.35 Ω	0.387 Ω/K	7.8 mK	±140 mK	±163 mK	±15.6 mK
		500	185.668 Ω	0.378 Ω/K	7.9 mK	±223 mK	±269 mK	±15.8 mK
<b>Silicon diode</b>	DT-670-C0-13 with 1.4H calibration	1.4	1.664 V	-12.49 mV/K	0.8 mK	±13 mK	±25 mK	±1.6 mK
		77	1.028 V	-1.73 mV/K	5.8 mK	±76 mK	±98 mK	±11.6 mK
		300	0.5596 V	-2.3 mV/K	4.3 mK	±47 mK	±79 mK	±8.7 mK
		500	0.0907 V	-2.12 mV/K	4.7 mK	±40 mK	±90 mK	±9.4 mK
<b>Silicon diode</b>	DT-470-SD-13 with 1.4H calibration	1.4	1.6981 V	-13.1 mV/K	0.8 mK	±13 mK	±25 mK	±1.6 mK
		77	1.0203 V	-1.92 mV/K	5.2 mK	±68 mK	±90 mK	±10.4 mK
		300	0.5189 V	-2.4 mV/K	4.2 mK	±44 mK	±76 mK	±8.4 mK
		475	0.0906 V	-2.22 mV/K	4.5 mK	±38 mK	±88 mK	±9.0 mK
<b>Thermocouple</b> 50 mV Option—3060	Type K	75	-5862.9 μV	15.6 μV/K	26 mK	±252 mK <sup>6</sup>	Calibration not available from Lake Shore	±52 mK
		300	1075.3 μV	40.6 μV/K	9.9 mK	±38 mK <sup>6</sup>		±19.6 mK
		600	13325 μV	41.7 μV/K	9.6 mK	±184 mK <sup>6</sup>		±19.2 mK
		1505	49998.3 μV	36.0 μV/K	11 mK	±730 mK <sup>6</sup>		±22.2 mK
<b>Capacitance</b> Option—3061	CS-501	4.2	6.0 nF	27 pF/K	1.9 mK	Not applicable	Calibration not available from Lake Shore	±3.8 mK
		77	9.1 nF	52 pF/K	1.0 mK			±2.0 mK
		200	19.2 nF	174 pF/K	2.9 mK			±5.8 mK

<sup>3</sup> Typical sensor sensitivities were taken from representative calibrations for the sensor listed<sup>4</sup> Control stability of the electronics only, in an ideal thermal system<sup>5</sup> Non-HT version maximum temperature: 325 K<sup>6</sup> Accuracy specification does not include errors from room temperature compensation



## Input specifications

Standard inputs	Sensor temperature coefficient	Input range	Excitation current	Display resolution	Measurement resolution <sup>7</sup>	Electronic accuracy (at 25 °C)	Measurement temperature coefficient	Electronic control stability <sup>8</sup>
NTC RTD/ PTC RTD 10 mV	Negative/	0 Ω to 10 Ω	1 mA <sup>10</sup>	0.1 mΩ	0.1 mΩ	±0.002 Ω ±0.06% of rdg	(0.01 mΩ + 0.001% of rdg)/°C	±0.2 mΩ
	Positive	0 Ω to 30 Ω	300 μA <sup>10</sup>	0.1 mΩ	0.3 mΩ	±0.002 Ω ±0.06% of rdg	(0.03 mΩ + 0.001% of rdg)/°C	±0.6 mΩ
		0 Ω to 100 Ω	100 μA <sup>10</sup>	1 mΩ	1 mΩ	±0.01 Ω ±0.04% of rdg	(0.1 mΩ + 0.001% of rdg)/°C	±2 mΩ
		0 Ω to 300 Ω	30 μA <sup>10</sup>	1 mΩ	3 mΩ	±0.01 Ω ±0.04% of rdg	(0.3 mΩ + 0.001% of rdg)/°C	±6 mΩ
		0 Ω to 1 kΩ	10 μA <sup>10</sup>	10 mΩ	10 mΩ	±0.1 Ω ±0.04% of rdg	(1 mΩ + 0.001% of rdg)/°C	±20 mΩ
		0 Ω to 3 kΩ	3 μA <sup>10</sup>	10 mΩ	30 mΩ	±0.1 Ω ±0.04% of rdg	(3 mΩ + 0.001% of rdg)/°C	±60 mΩ
		0 Ω to 10 kΩ	1 μA <sup>10</sup>	100 mΩ	100 mΩ	±1.0 Ω ±0.04% of rdg	(10 mΩ + 0.001% of rdg)/°C	±200 mΩ
		0 Ω to 30 kΩ	300 nA <sup>10</sup>	100 mΩ	300 mΩ	±2.0 Ω ±0.04% of rdg	(30 mΩ + 0.001% of rdg)/°C	±600 mΩ
		0 Ω to 100 kΩ	100 nA <sup>10</sup>	1 Ω	1 Ω	±10.0 Ω ±0.04% of rdg	(100 mΩ + 0.001% of rdg)/°C	±2 Ω
		0 Ω to 300 kΩ	30 nA <sup>10</sup>	1 Ω	3 Ω	±30 Ω ±0.04% of rdg	(300 mΩ + 0.001% of rdg)/°C	±6 Ω
NTC RTD 1 mV	Negative	0 Ω to 10 Ω	100 μA <sup>10</sup>	0.1 mΩ	1 mΩ	±0.01 Ω ±0.04% of rdg	(0.1 mΩ + 0.001% of rdg)/°C	±2 mΩ
		0 Ω to 30 Ω	30 μA <sup>10</sup>	0.1 mΩ	3 mΩ	±0.01 Ω ±0.04% of rdg	(0.3 mΩ + 0.001% of rdg)/°C	±6 mΩ
		0 Ω to 100 Ω	10 μA <sup>10</sup>	1 mΩ	10 mΩ	±0.1 Ω ±0.04% of rdg	(1 mΩ + 0.001% of rdg)/°C	±20 mΩ
		0 Ω to 300 Ω	3 μA <sup>10</sup>	1 mΩ	30 mΩ	±0.1 Ω ±0.04% of rdg	(3 mΩ + 0.001% of rdg)/°C	±60 mΩ
		0 Ω to 1 kΩ	1 μA <sup>10</sup>	10 mΩ	100 mΩ	±1.0 Ω ±0.04% of rdg	(10 mΩ + 0.001% of rdg)/°C	±200 mΩ
		0 Ω to 3 kΩ	300 nA <sup>10</sup>	10 mΩ	300 mΩ	±2.0 Ω ±0.04% of rdg	(30 mΩ + 0.001% of rdg)/°C	±600 mΩ
		0 Ω to 10 kΩ	100 nA <sup>10</sup>	100 mΩ	1 Ω	±10.0 Ω ±0.04% of rdg	(100 mΩ + 0.001% of rdg)/°C	±2 Ω
		0 Ω to 30 kΩ	30 nA <sup>10</sup>	100 mΩ	3 Ω	±30 Ω ±0.04% of rdg	(300 mΩ + 0.001% of rdg)/°C	±6 Ω
		0 Ω to 100 kΩ	10 nA <sup>10</sup>	1 Ω	10 Ω	±100 Ω ±0.04% of rdg	(1 Ω + 0.001% of rdg)/°C	±20 Ω

Scanner option Model 3062	Sensor temperature coefficient	Input range	Excitation current	Display resolution	Measurement resolution	Electronic accuracy (at 25 °C)	Measurement temperature coefficient	Electronic control stability <sup>8</sup>
Diode	Negative	0 V to 2.5 V	10 μA ±0.05% <sup>9</sup>	10 μV	10 μV	±80 μV ±0.005% of rdg	(10 μV + 0.0005% of rdg)/°C	±20 μV
	Negative	0 V to 10 V	10 μA ±0.05% <sup>9</sup>	100 μV	20 μV	±160 μV ±0.01% of rdg	(20 μV + 0.0005% of rdg)/°C	±40 μV
PTC RTD	Positive	0 Ω to 10 Ω	1 mA <sup>10</sup>	0.1 mΩ	0.2 mΩ	±0.002 Ω ±0.01% of rdg	(0.01 mΩ + 0.001% of rdg)/°C	±0.2 mΩ
		0 Ω to 30 Ω	1 mA <sup>10</sup>	0.1 mΩ	0.2 mΩ	±0.002 Ω ±0.01% of rdg	(0.03 mΩ + 0.001% of rdg)/°C	±0.4 mΩ
		0 Ω to 100 Ω	1 mA <sup>10</sup>	1 mΩ	2 mΩ	±0.004 Ω ±0.01% of rdg	(0.1 mΩ + 0.001% of rdg)/°C	±4 mΩ
		0 Ω to 300 Ω	1 mA <sup>10</sup>	1 mΩ	2 mΩ	±0.004 Ω ±0.01% of rdg	(0.3 mΩ + 0.001% of rdg)/°C	±4 mΩ
		0 Ω to 1 kΩ	1 mA <sup>10</sup>	10 mΩ	20 mΩ	±0.04 Ω ±0.02% of rdg	(1 mΩ + 0.001% of rdg)/°C	±40 mΩ
		0 Ω to 3 kΩ	1 mA <sup>10</sup>	10 mΩ	20 mΩ	±0.04 Ω ±0.02% of rdg	(3 mΩ + 0.001% of rdg)/°C	±40 mΩ
NTC RTD 10 mV	Negative	0 Ω to 10 kΩ	1 mA <sup>10</sup>	100 mΩ	200 mΩ	±0.4 Ω ±0.02% of rdg	(10 mΩ + 0.001% of rdg)/°C	±400 mΩ
		0 Ω to 10 Ω	1 mA <sup>10</sup>	0.1 mΩ	0.15 mΩ	±0.002 Ω ±0.06% of rdg	(0.01 mΩ + 0.001% of rdg)/°C	±0.3 mΩ
		0 Ω to 30 Ω	300 μA <sup>10</sup>	0.1 mΩ	0.45 mΩ	±0.002 Ω ±0.06% of rdg	(0.03 mΩ + 0.0015% of rdg)/°C	±0.9 mΩ
		0 Ω to 100 Ω	100 μA <sup>10</sup>	1 mΩ	1.5 mΩ	±0.01 Ω ±0.04% of rdg	(0.1 mΩ + 0.001% of rdg)/°C	±3 mΩ
		0 Ω to 300 Ω	30 μA <sup>10</sup>	1 mΩ	4.5 mΩ	±0.01 Ω ±0.04% of rdg	(0.3 mΩ + 0.0015% of rdg)/°C	±9 mΩ
		0 Ω to 1 kΩ	10 μA <sup>10</sup>	10 mΩ	15 mΩ + 0.002% of rdg	±0.1 Ω ±0.04% of rdg	(1 mΩ + 0.001% of rdg)/°C	±30 mΩ ±0.004% of rdg
		0 Ω to 3 kΩ	3 μA <sup>10</sup>	10 mΩ	45 mΩ + 0.002% of rdg	±0.1 Ω ±0.04% of rdg	(3 mΩ + 0.0015% of rdg)/°C	±90 mΩ ±0.004% of rdg
		0 Ω to 10 kΩ	1 μA <sup>10</sup>	100 mΩ	150 mΩ + 0.002% of rdg	±1.0 Ω ±0.04% of rdg	(10 mΩ + 0.001% of rdg)/°C	±300 mΩ ±0.004% of rdg
		0 Ω to 30 kΩ	300 nA <sup>10</sup>	100 mΩ	450 mΩ + 0.002% of rdg	±2.0 Ω ±0.04% of rdg	(30 mΩ + 0.001% of rdg)/°C	±900 mΩ ±0.004% of rdg
		0 Ω to 100 kΩ	100 nA <sup>10</sup>	1 Ω	1.5 Ω + 0.005% of rdg	±10.0 Ω ±0.04% of rdg	(100 mΩ + 0.002% of rdg)/°C	±3 Ω ±0.01% of rdg

Thermocouple option Model 3060	Sensor temperature coefficient	Input range	Excitation current	Display resolution	Measurement resolution	Electronic accuracy (at 25 °C)	Measurement temperature coefficient	Electronic control stability <sup>8</sup>
Thermocouple	Positive	±50 mV	NA	0.1 μV	0.4 μV	±1 μV ±0.05% of rdg <sup>11</sup>	(0.1 μV + 0.001% of rdg)/°C	±0.8 μV

Capacitance option Model 3061	Sensor temperature coefficient	Input range	Excitation current	Display resolution	Measurement resolution	Electronic accuracy (at 25 °C)	Measurement temperature coefficient	Electronic control stability <sup>8</sup>
Capacitance	Positive or	0.1 to 15 nF	3.496 kHz 1 mA square wave	0.1 pF	0.05 pF	±50 pF ±0.4% of rdg	2.5 pF/°C	0.1 pF
	Negative	1 to 150 nF	3.496 kHz 10 mA square wave	1 pF	0.5 pF	±50 pF ±0.4% of rdg	5 pF/°C	1 pF

<sup>7</sup> Measurement resolution measured at 4.2 K to remove the thermal noise of the resistor

<sup>8</sup> Control stability of the electronics only, in ideal thermal system

<sup>9</sup> Current source error has negligible effect on measurement accuracy

<sup>10</sup> Current source error is removed during calibration

<sup>11</sup> Accuracy specification does not include errors from room temperature compensation



## Thermometry

**Number of inputs** 4 (8 with scanner option)

**Input configuration** Inputs can be configured from the front panel to accept any of the supported input types. Thermocouple, capacitance and diode inputs require an optional input card that can be installed in the field.

**Isolation** Sensor inputs optically isolated from other circuits but not each other

**A/D resolution** 24-bit

**Input accuracy** Sensor dependent, refer to Input Specifications table

**Measurement resolution** Sensor dependent, refer to Input Specifications table

**Maximum update rate** 10 rdg/s on each non-scanned input

**Maximum update rate (scanner)** The maximum update rate for a scanned input is 10 rdg/s distributed among the enabled channels. Any channel configured as 100 k $\Omega$  RTD with reversal on changes the update rate for the channel to 5 rdg/s.

Scanner channels enabled*	Update rate
1	10 rdg/s (100 ms/rdg)
2	5 rdg/s (200 ms/rdg)
3	3 $\frac{1}{3}$ rdg/s (300 ms/rdg)
4	2 $\frac{1}{2}$ rdg/s (400 ms/rdg)
5	2 rdg/s (500 ms/rdg)

\* No channels configured for 100 k $\Omega$  NTC RTD

**Autorange** Automatically selects appropriate NTC RTD or PTC RTD range

**User curves** Room for 39 200-point CalCurves™ or user curves

**SoftCal™** Improves accuracy of DT-470 diode to  $\pm 0.25$  K from 30 K to 375 K; improves accuracy of platinum RTDs to  $\pm 0.25$  K from 70 K to 325 K; stored as user curves

**Math** Maximum and minimum

**Filter** Averages 2 to 64 input readings

## Control

**Control outputs** 4

### Heater outputs (Outputs 1 & 2)

**Control type** Closed loop digital PID with manual heater output or open loop

**Update rate** 10/s

**Tuning** Autotune (one loop at a time), PID, PID zones

**Control stability** Sensor dependent, see Input Specifications table

**PID control settings**

Proportional (gain)	0 to 9999 with 0.1 setting resolution
Integral (reset)	1 to 1000 (1000/s) with 0.1 setting resolution
Derivative (rate)	1 to 200% with 1% resolution
Manual output	0 to 100% with 0.01% setting resolution

**Zone control** 10 temperature zones with P, I, D, manual heater out, heater range, control channel, ramp rate

**Setpoint ramping** 0.001 K/min to 100 K/min

### Analog outputs (Outputs 3 & 4)

**Control type** Closed loop PID, PID zones, warm up heater mode, still heater, manual output, or monitor output

**Warm up heater mode settings**

Warm up percentage	0 to 100% with 1% resolution
Warm up mode	Continuous control or auto-off

**Monitor output settings**

Scale	User selected
Data source	Temperature or sensor units
Settings	Input, source, top of scale, bottom of scale, or manual

**Type** Variable DC voltage source

**Update rate** 10/s

**Range**  $\pm 10$  V

**Resolution** 16-bit, 0.3 mV

**Accuracy**  $\pm 2.5$  mV

**Noise** 0.3 mV RMS

**Maximum current** 100 mA

**Maximum power** 1 W (into 100  $\Omega$ )

**Minimum load resistance** 100  $\Omega$  (short-circuit protected)

**Connector** Detachable terminal block

## Output 1

	25 $\Omega$ setting	50 $\Omega$ setting
<b>Type</b>	Variable DC current source	
<b>D/A resolution</b>	16-bit	
<b>Max power</b>	75 W	50 W
<b>Max current</b>	1.732 A	1 A
<b>Voltage compliance (min)</b>	50 V	50 V
<b>Heater load for max power</b>	25 $\Omega$	50 $\Omega$
<b>Heater load range</b>	10 $\Omega$ to 100 $\Omega$	
<b>Ranges</b>	5 (decade steps in power)	
<b>Heater noise</b>	1.2 $\mu$ A RMS (dominated by line frequency and its harmonics)	
<b>Grounding</b>	Output referenced to chassis ground	
<b>Heater connector</b>	Dual banana	
<b>Safety limits</b>	Curve temperature, power up heater off, short circuit protection	

## Output 2

<b>Type</b>	Variable DC current source	
<b>D/A resolution</b>	16-bit	
<b>Max power</b>	1 W	
<b>Max current</b>	100 mA	
<b>Voltage compliance (min)</b>	10 V	
<b>Heater load for max power</b>	100 $\Omega$	
<b>Heater load range</b>	25 $\Omega$ to 2 k $\Omega$	
<b>Ranges (100 <math>\Omega</math> load)</b>	1 W, 100 mW, 10 mW, 1 mW, 100 $\mu$ W	
<b>Heater noise</b>	<0.005% of range	
<b>Grounding</b>	Output referenced to measurement common	
<b>Heater connector</b>	Dual banana	
<b>Safety limits</b>	Curve temperature, power up heater off, short circuit protection	

## Sensor input configuration

	RTD	Diode (option)	Thermocouple (option)	Capacitance (option)
<b>Measurement type</b>	4-lead differential	4-lead differential	2-lead differential, room temperature compensated	4-lead differential, variable duty cycle
<b>Excitation</b>	Constant current with current reversal	10 $\mu$ A constant current	N/A	Constant current, 3.496 kHz square wave
<b>Supported sensors</b>	100 $\Omega$ Platinum, 1000 $\Omega$ Platinum, Germanium, Carbon-Glass, Cernox®, and Rox™	Silicon, GaAlAs	Most thermocouple types	CS-501GR
<b>Standard curves</b>	PT-100, PT-1000, RX-102A, RX-202A	DT-470, DT-670, DT-500-D, DT-500-E1	Type E, Type K, Type T, AuFe 0.07% vs. Cr, AuFe 0.03% vs Cr	N/A
<b>Input connector</b>	6-pin DIN	6-pin DIN	Screw terminals in a ceramic isothermal block	6-pin DIN



## Front panel

**Display** 8-line by 40-character (240 × 64 pixel) graphic LCD display module with LED backlight

**Number of reading displays** 1 to 8

**Display units** K, °C, V, mV, Ω, nF

**Reading source** Temperature, sensor units, max, and min

**Display update rate** 2 rdg/s

**Temperature display resolution** 0.00001° from 0° to 9.99999°, 0.0001° from 10° to 99.9999°, 0.001° from 100° to 999.999°, 0.01° above 1000°

**Sensor units display resolution** Sensor dependent, to 6 digits

**Other displays** Input name, setpoint, heater range, heater output, and PID

**Setpoint setting resolution** Same as display resolution (actual resolution is sensor dependent)

**Heater output display** Numeric display in percent of full scale for power or current

**Heater output resolution** 0.01%

**Display annunciators** Control input, alarm, tuning

**LED annunciators** Remote, Ethernet status, alarm, control outputs

**Keypad** 27-key silicone elastomer keypad

**Front panel features** Front panel curve entry, display contrast control, and keypad lock-out

## Interface

### IEEE-488.2

Capabilities SH1, AH1, T5, L4, SR1, RL1, PP0, DC1, DT0, C0, E1

Reading rate To 10 rdg/s on each input

Software support LabVIEW™ driver (see [www.lakeshore.com](http://www.lakeshore.com))

### USB

Function Emulates a standard RS-232 serial port

Baud rate 57,600

Connector B-type USB connector

Reading rate To 10 rdg/s on each input

Software support LabVIEW™ driver (see [www.lakeshore.com](http://www.lakeshore.com))

### Ethernet

Function TCP/IP, web interface, curve handler, configuration backup, chart recorder

Connector RJ-45

Reading rate To 10 rdg/s on each input

Software support LabVIEW™ driver (see [www.lakeshore.com](http://www.lakeshore.com))

### Alarms

Number 4 (8 with scanner option), high and low for each input

Data source Temperature or sensor units

Settings Source, high setpoint, low setpoint, deadband, latching or non-latching, audible on/off, and visible on/off

Actuators Display annunciator, beeper, and relays

### Relays

Number 2

Contacts Normally open (NO), normally closed (NC), and common (C)

Contact rating 30 VDC at 3 A

Operation Activate relays on high, low, or both alarms for any input, or manual mode

Connector Detachable terminal block

## General

**Ambient temperature** 15 °C to 35 °C at rated accuracy; 5 °C to 40 °C at reduced accuracy

**Power requirement** 100, 120, 220, 240 VAC, ±10%, 50 or 60 Hz, 220 VA

**Size** 435 mm W × 89 mm H × 368 mm D (17 in × 3.5 in × 14.5 in), full rack

**Weight** 7.6 kg (16.8 lb)

**Approval** CE mark, RoHS

## Ordering information

### Part number Description

**350**

2 diode/resistor inputs temperature controller, includes one dual banana jack heater output connector, four 6-pin DIN plug sensor input mating connectors, one 10-pin terminal block, a calibration certificate and a user's manual

**350-3060**

Model 350 with a 3060 option card installed

**350-3061**

Model 350 with a 3061 option card installed

**350-3062**

Model 350 with a 3062 option card installed

**3060**

2-thermocouple input option for 350/336, field-installable

**3061**

Capacitance input option for 350/336, field-installable

**3062**

4-channel scanner option for diodes and RTD sensors for 350/336, field-installable

### Please indicate your power/cord configuration:

**1** 100 V—U.S. cord (NEMA 5-15)

**2** 120 V—U.S. cord (NEMA 5-15)

**3** 220 V—Euro cord (CEE 7/7)

**4** 240 V—Euro cord (CEE 7/7)

**5** 240 V—U.K. cord (BS 1363)

**6** 240 V—Swiss cord (SEV 1011)

**7** 220 V—China cord (GB 1002)

### Accessories

**112-177**

Temperature controller cable, 3 m (10 ft)—IN STOCK

**112-178**

Temperature controller cable, 6 m (20 ft)

**112-180**

Temperature controller cable, 10 m (33 ft)

**6201**

1 m (3.3 ft long) IEEE-488 (GPIB) computer interface cable assembly

**RM-1**

Rack mount kit for mounting one full rack temperature instrument

**G-106-233**

Sensor input mating connector (6-pin DIN plug)

**G-106-755**

Terminal block, 10-pin

**106-009**

Banana plug, dual

**CAL-350-CERT**

Instrument calibration with certificate

**CAL-350-DATA**

Instrument recalibration with certificate and data

**119-057**

Model 350 temperature controller manual

*All specifications are subject to change without notice*





## Model 336 Temperature Controller



### Model 336 features

- Operates down to 300 mK with appropriate NTC RTD sensors
- Four sensor inputs and four independent control outputs
- Two PID control loops: 100 W and 50 W into a 50  $\Omega$  or 25  $\Omega$  load
- Autotuning automatically calculates PID parameters
- Automatically switch sensor inputs using zones to allow continuous measurement and control from 300 mK to 1505 K
- Custom display setup allows you to label each sensor input
- Ethernet, USB and IEEE-488 interfaces
- Supports diode, RTD, and thermocouple temperature sensors
- Sensor excitation current reversal eliminates thermal EMF errors for resistance sensors
- $\pm 10$  V analog voltage outputs, alarms, and relays
- CE certification
- Full 3 year standard warranty





## Introduction

The first of a new generation of innovative temperature measurement and control solutions by Lake Shore, the Model 336 temperature controller comes standard equipped with many advanced features promised to deliver the functionality and reliable service you've come to expect from the world leader in cryogenic thermometry. The Model 336 is the only temperature controller available with four sensor inputs, four control outputs and 150 W of low noise heater power. Two independent heater outputs providing 100 W and 50 W can be associated with any of the four sensor inputs and programmed for closed loop temperature control in proportional-integral-derivative (PID) mode. The improved autotuning feature of the Model 336 can be used to automatically calculate PID parameters, so you spend less time tuning your controller and more time conducting experiments.



The Model 336 supports the industry's most advanced line of cryogenic temperature sensors as manufactured by Lake Shore, including diodes, resistance temperature detectors (RTDs) and thermocouples. The controller's zone tuning feature allows you to measure and control temperatures seamlessly from 300 mK to over 1,500 K by automatically switching temperature sensor inputs when your temperature range goes beyond the usable range of a given sensor. You'll never again have to be concerned with temperature sensor over or under errors and measurement continuity issues. Alarms, relays, and  $\pm 10$  V analog voltage outputs are available to help automate secondary control functions.

Another innovative first from Lake Shore, the ability to custom label sensor inputs eliminates the guesswork in remembering or determining the location to which a sensor input is associated. As we strive to maintain increasingly demanding workloads, ease of use and the ability to stay connected from anywhere in the world are critical attributes. With standard Ethernet, USB, and IEEE-488 interfaces and an intuitive menu structure and logic, the Model 336 was designed with efficiency, reliable connectivity, and ease of use in mind. While you may need to leave your lab, Ethernet ensures you'll always be connected to your experiments. The new intuitive front panel layout and keypad logic, bright graphic display, and LED indicators enhance the user friendly front panel interface of the Model 336.

In many applications, the unparalleled feature set of the Model 336 allows you to replace several instruments with one, saving time, money and valuable laboratory space. Delivering more feedback, tighter control, and faster cycle times, the Model 336 keeps up with increasingly complex temperature measurement and control applications. It is the ideal solution for general purpose to advanced laboratory applications. Put the Model 336 temperature controller to use in your lab and let it take control of your measurement environment.

## Sensor inputs

The Model 336 offers four standard sensor inputs that are compatible with diode and RTD temperature sensors. The field installable Model 3060 thermocouple input option provides support for up to two thermocouple inputs by adding thermocouple functionality to inputs C and D.

Sensor inputs feature a high-resolution 24-bit analog-to-digital converter; each input has its own current source, providing fast settling times. All four sensor inputs are optically isolated from other circuits to reduce noise and to provide repeatable sensor measurements. Current reversal eliminates thermal electromotive force (EMF) errors in resistance sensors. Nine excitation currents facilitate temperature measurement and control down to 300 mK using appropriate negative temperature coefficient (NTC) RTDs. Autorange mode automatically scales excitation current in NTC RTDs to reduce self heating at low temperatures as sensor resistance changes by many orders of magnitude. Temperatures down to 1.4 K can be measured and controlled using silicon or GaAlAs diodes. Software selects the appropriate excitation current and signal gain levels when the sensor type is entered via the instrument front panel. The unique zone setting feature automatically switches sensor inputs, enabling you to measure temperatures from 300 mK to over 1,500 K without interrupting your experiment.

The Model 336 includes standard temperature sensor response curves for silicon diodes, platinum RTDs, ruthenium oxide RTDs, and thermocouples. Non-volatile memory can also store up to 39 200-point CalCurves for Lake Shore calibrated temperature sensors or user curves. Temperature sensor calibration data can be easily uploaded and manipulated using the Lake Shore curve handler software.



## Temperature control

Providing a total of 150 W of heater power, the Model 336 is the most powerful temperature controller available. Delivering very clean heater power, it precisely controls temperature throughout the full scale temperature range for excellent measurement reliability, efficiency, and throughput. Two independent PID control outputs supplying 100 W and 50 W of heater power can be associated with any of the four standard sensor inputs. Precise control output is calculated based on your temperature setpoint and feedback from the control sensor. Wide tuning parameters accommodate most cryogenic cooling systems and many high-temperature ovens commonly used in laboratories. PID values can be manually set for fine control, or the improved autotuning feature can automate the tuning process. Autotune calculates PID parameters and provides information to help build zone tables. The setpoint ramp feature provides smooth, continuous setpoint changes and predictable setpoint approaches without the worry of overshoot or excessive settling times. When combined with the zone setting feature, which enables automatic switching of sensor inputs and scales current excitation through ten different preloaded temperature zones, the Model 336 provides continuous measurement and control from 300 mK to 1505 K.

Control outputs 1 and 2 are variable DC current sources referenced to chassis ground. Output 1 can provide 100 W of continuous power to a 25  $\Omega$  load or 50 W to a 50  $\Omega$  or 25  $\Omega$  load. Output 2 provides 50 W to 25  $\Omega$  or 50  $\Omega$  heater loads. Outputs 3 and 4 are variable DC voltage source outputs providing two  $\pm 10$  V analog outputs. When not in use to extend the temperature controller heater power, these outputs can function as manually controlled voltage sources.

Temperature limit settings for inputs are provided as a safeguard against system damage. Each input is assigned a temperature limit, and if any input exceeds that limit, all control channels are automatically disabled.

## Interface

The Model 336 is standard equipped with Ethernet, universal serial bus (USB) and parallel (IEEE-488) interfaces. In addition to gathering data, nearly every function of the instrument can be controlled through a computer interface. You can download the Lake Shore curve handler software to your computer to easily enter and manipulate sensor calibration curves for storage in the instruments non-volatile memory.



### Four input/output display with labels

Standard display option featuring all four inputs and associated outputs.



### Two input/output display with labels

Reading locations can be user configured to meet application needs. Here, the input name is shown above each measurement reading along with the designated input letter.

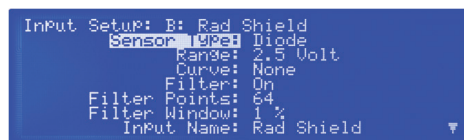

### Intuitive menu structure

Logical navigation allows you to spend more time on research and less time on setup.

Ethernet provides the ability to access and monitor instrument activities via the internet from anywhere in the world. The USB interface emulates an RS-232C serial port at a fixed 57,600 baud rate, but with the physical connections of a USB. It also allows you to download firmware upgrades, ensuring the most current firmware version is loaded into your instrument without having to physically change anything.

Each sensor input has a high and low alarm that offer latching and non-latching operation. The two relays can be used in conjunction with the alarms to alert you of a fault condition and perform simple on/off control. Relays can be assigned to any alarm or operated manually.

The  $\pm 10$  V analog voltage outputs on outputs 3 and 4 can be configured to send a voltage proportional to temperature to a strip chart recorder or data acquisition system. You may select the scale and data sent to the output, including temperature or sensor units.

## Model 336 rear panel

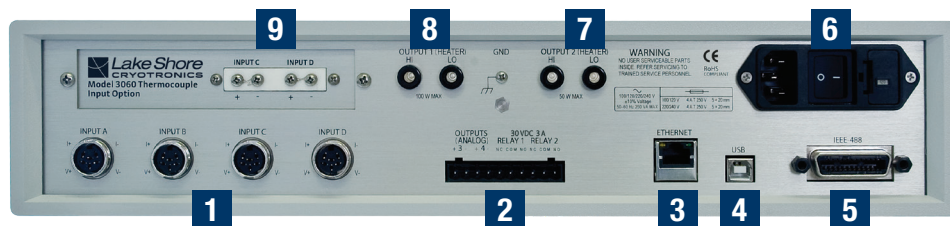

- 1 Sensor input connectors
- 2 Terminal block (analog outputs and relays)
- 3 Ethernet interface
- 4 USB interface
- 5 IEEE-488 interface
- 6 Line input assembly
- 7 Output 2 heater
- 8 Output 1 heater
- 9 Thermocouple option inputs



### Configurable display

The Model 336 offers a bright, graphic liquid crystal display with an LED backlight that simultaneously displays up to eight readings. You can show all four loops, or if you need to monitor one input, you can display just that one in greater detail. Or you can custom configure each display location to suit your experiment. Data from any input can be assigned to any of the locations, and your choice of temperature or sensor units can be displayed. For added convenience, you can also custom label each sensor input, eliminating the guesswork in remembering or determining the location to which a sensor input is associated.

### Model 3060 thermocouple input option

The field installable Model 3060 thermocouple input option adds thermocouple functionality to inputs C and D. While the option can be easily removed, this is not necessary as the standard inputs remain fully functional when they are not being used to measure thermocouple temperature sensors. Calibration for the option is stored on the card so it can be installed in the field and used with multiple Model 336 temperature controllers without recalibration.

## Sensor selection

### Sensor temperature range (sensors sold separately)

		Model	Useful range	Magnetic field use
<b>Diodes</b>	Silicon diode	DT-670-SD	1.4 K to 500 K	$T \geq 60 \text{ K} \ \& \ B \leq 3 \text{ T}$
	Silicon diode	DT-670E-BR	30 K to 500 K	$T \geq 60 \text{ K} \ \& \ B \leq 3 \text{ T}$
	Silicon diode	DT-414	1.4 K to 375 K	$T \geq 60 \text{ K} \ \& \ B \leq 3 \text{ T}$
	Silicon diode	DT-421	1.4 K to 325 K	$T \geq 60 \text{ K} \ \& \ B \leq 3 \text{ T}$
	Silicon diode	DT-470-SD	1.4 K to 500 K	$T \geq 60 \text{ K} \ \& \ B \leq 3 \text{ T}$
<b>Positive temperature coefficient RTDs</b>	100 $\Omega$ platinum	PT-102/3	14 K to 873 K	$T > 40 \text{ K} \ \& \ B \leq 2.5 \text{ T}$
	100 $\Omega$ platinum	PT-111	14 K to 673 K	$T > 40 \text{ K} \ \& \ B \leq 2.5 \text{ T}$
	Rhodium-iron	RF-800-4	1.4 K to 500 K	$T > 77 \text{ K} \ \& \ B \leq 8 \text{ T}$
<b>Negative temperature coefficient RTDs</b>	Cernox <sup>®</sup>	CX-1010	0.3 K to 325 K <sup>1</sup>	$T > 2 \text{ K} \ \& \ B \leq 19 \text{ T}$
	Cernox <sup>®</sup>	CX-1050-HT	1.4 K to 420 K <sup>1</sup>	$T > 2 \text{ K} \ \& \ B \leq 19 \text{ T}$
	Cernox <sup>®</sup>	CX-1070-HT	4 K to 420 K <sup>1</sup>	$T > 2 \text{ K} \ \& \ B \leq 19 \text{ T}$
	Cernox <sup>®</sup>	CX-1080-HT	20 K to 420 K <sup>1</sup>	$T > 2 \text{ K} \ \& \ B \leq 19 \text{ T}$
	Germanium	GR-300-AA	0.35 K to 100 K <sup>3</sup>	Not recommended
	Germanium	GR-1400-AA	1.8 K to 100 K <sup>3</sup>	Not recommended
	Rox <sup>™</sup>	RX-102	0.3 K to 40 K <sup>3</sup>	$T > 2 \text{ K} \ \& \ B \leq 10 \text{ T}$
	Rox <sup>™</sup>	RX-103	1.4 K to 40 K	$T > 2 \text{ K} \ \& \ B \leq 10 \text{ T}$
	Rox <sup>™</sup>	RX-202	0.3 K to 40 K <sup>3</sup>	$T > 2 \text{ K} \ \& \ B \leq 10 \text{ T}$
	<b>Thermocouples</b>	Type K	9006-006	3.2 K to 1505 K
Option—3060 Type E		9006-004	3.2 K to 934 K	Not recommended

<sup>1</sup> Non-HT version maximum temperature: 325 K

<sup>2</sup> Low temperature limited by input resistance range

<sup>3</sup> Low temperature specified with self-heating error:  $\leq 5 \text{ mK}$

**Silicon diodes** are the best choice for general cryogenic use from 1.4 K to above room temperature. Silicon diodes are economical to use because they follow a standard curve and are interchangeable in many applications. They are not suitable for use in ionizing radiation or magnetic fields.

**Cernox<sup>®</sup>** thin-film RTDs offer high sensitivity and low magnetic field-induced errors over the 0.3 K to 420 K temperature range. Cernox sensors require calibration.

**Platinum RTDs** offer high uniform sensitivity from 30 K to over 800 K. With excellent reproducibility, they are useful as thermometry standards. They follow a standard curve above 70 K and are interchangeable in many applications.





## Typical sensor performance

	Example Lake Shore sensor	Temperature	Nominal resistance/voltage	Typical sensor sensitivity <sup>4</sup>	Measurement resolution: temperature equivalents	Electronic accuracy: temperature equivalents	Temperature accuracy including electronic accuracy, Calcurve™, and calibrated sensor	Electronic control stability <sup>5</sup> : temperature equivalents
<b>Silicon diode</b>	DT-670-CO-13 with 1.4H calibration	1.4 K	1.664 V	-12.49 mV/K	0.8 mK	±13 mK	±25 mK	±1.6 mK
		77 K	1.028 V	-1.73 mV/K	5.8 mK	±76 mK	±98 mK	±11.6 mK
		300 K	0.5596 V	-2.3 mV/K	4.3 mK	±47 mK	±79 mK	±8.7 mK
		500 K	0.0907 V	-2.12 mV/K	4.7 mK	±40 mK	±90 mK	±9.4 mK
<b>Silicon diode</b>	DT-470-SD-13 with 1.4H calibration	1.4 K	1.6981 V	-13.1 mV/K	0.8 mK	±13 mK	±25 mK	±1.6 mK
		77 K	1.0203 V	-1.92 mV/K	5.2 mK	±68 mK	±90 mK	±10.4 mK
		300 K	0.5189 V	-2.4 mV/K	4.2 mK	±44 mK	±76 mK	±8.4 mK
		475 K	0.0906 V	-2.22 mV/K	4.5 mK	±38 mK	±88 mK	±9 mK
<b>100 Ω platinum RTD 500 Ω full scale</b>	PT-103 with 14J calibration	30 K	3.660 Ω	0.191 Ω/K	1.1 mK	±13 mK	±23 mK	±2.2 mK
		77 K	20.38 Ω	0.423 Ω/K	0.5 mK	±10 mK	±22 mK	±1.0 mK
		300 K	110.35 Ω	0.387 Ω/K	5.2 mK	±39 mK	±62 mK	±10.4 mK
		500 K	185.668 Ω	0.378 Ω/K	5.3 mK	±60 mK	±106 mK	±10.6 mK
<b>Cernox®</b>	CX-1010-SD with 0.3L calibration	0.3 K	2322.4 Ω	-10785 Ω/K	8.5 μK	±0.1 mK	±3.6 mK	±17 μK
		0.5 K	1248.2 Ω	-2665.2 Ω/K	26 μK	±0.2 mK	±4.7 mK	±52 μK
		4.2 K	277.32 Ω	-32.209 Ω/K	140 μK	±3.8 mK	±8.8 mK	±280 μK
		300 K	30.392 Ω	-0.0654 Ω/K	23 mK	±339 mK	±414 mK	±46 mK
<b>Cernox®</b>	CX-1050-SD-HT <sup>6</sup> with 1.4M calibration	1.4 K	26566 Ω	-48449 Ω/K	20 μK	±0.3 mK	±5.3 mK	±40 μK
		4.2 K	3507.2 Ω	-1120.8 Ω/K	196 μK	±2.1 mK	±7.1 mK	±392 μK
		77 K	205.67 Ω	-2.4116 Ω/K	1.9 mK	±38 mK	±54 mK	±3.8 mK
		420 K	45.03 Ω	-0.0829 Ω/K	18 mK	±338 mK	±403 mK	±36 mK
<b>Germanium</b>	GR-300-AA with 0.3D calibration	0.35 K	18225 Ω	-193453 Ω/K	4 μK	±48 μK	±4.2 mK	±8 μK
		1.4 K	449 Ω	-581 Ω/K	41 μK	±481 μK	±4.7 mK	±82 μK
		4.2 K	94 Ω	-26.6 Ω/K	56 μK	±1.8 mK	±6.8 mK	±112 μK
		100 K	2.7 Ω	-0.024 Ω/K	6.3 mK	±152 mK	±175 mK	±12.6 mK
<b>Germanium</b>	GR-1400-AA with 1.4D calibration	1.8 K	15288 Ω	-26868 Ω/K	28 μK	±302 μK	±4.5 mK	±56 μK
		4.2 K	1689 Ω	-862 Ω/K	91 μK	±900 μK	±5.1 mK	±182 μK
		10 K	253 Ω	-62.0 Ω/K	73 μK	±1.8 mK	±6.8 mK	±146 μK
		100 K	2.8 Ω	-0.021 Ω/K	7.1 mK	±177 mK	±200 mK	±14.2 mK
<b>Rox™</b>	RX-102A-AA with 0.3B calibration	0.5 K	3701 Ω	-5478 Ω/K	41 μK	±0.5 mK	±5 mK	±82 μK
		1.4 K	2005 Ω	-667 Ω/K	128 μK	±1.4 mK	±6.4 mK	±256 μK
		4.2 K	1370 Ω	-80.3 Ω/K	902 μK	±8 mK	±24 mK	±1.8 mK
		40 K	1049 Ω	-1.06 Ω/K	62 mK	±500 mK	±537 mK	±124 mK
<b>Thermocouple 50 mV Option—3060</b>	Type K	75 K	-5862.9 μV	15.6 μV/K	26 mK	±0.25 K <sup>7</sup>	Calibration not available from Lake Shore	±52 mK
		300 K	1075.3 μV	40.6 μV/K	10 mK	±0.038 K <sup>7</sup>		±19.6 mK
		600 K	13325 μV	41.7 μV/K	10 mK	±0.184 K <sup>7</sup>		±20 mK
		1505 K	49998.3 μV	36.0 μV/K	11 mK	±0.73 K <sup>7</sup>		±22 mK
<b>Capacitance Option—3061</b>	CS-501	4.2 K	6.0 nF	27 pF/K	1.9 mK	NA	Calibration not available from Lake Shore	±3.8 mK
		77 K	9.1 nF	52 pF/K	1.0 mK			±2.0 mK
		200 K	19.2 nF	174 pF/K	2.9 mK			±5.8 mK

<sup>4</sup> Typical sensor sensitivities were taken from representative calibrations for the sensor listed<sup>5</sup> Control stability of the electronics only, in an ideal thermal system<sup>6</sup> Non-HT version maximum temperature: 325 K<sup>7</sup> Accuracy specification does not include errors from room temperature compensation



## Model 336 Specifications

### Input specifications

Standard inputs and scanner option <i>Model 3062</i>	Sensor temperature coefficient	Input range	Excitation current	Display resolution	Measurement resolution	Electronic accuracy at 25 °C <sup>8</sup> [for the 3062 scanner option card]	Measurement temperature coefficient	Electronic control stability <sup>9</sup>
<b>Diode</b>	Negative	0 V to 2.5 V	10 µA ±0.05% <sup>10,11</sup>	10 µV	10 µV	±80 µV ±0.005% of rdg [±250 µV ±0.025% of rdg]	(10 µV + 0.0005% of rdg)/°C	±20 µV
		0 V to 10 V	10 µA ±0.05% <sup>10,11</sup>	100 µV	20 µV	±160 µV ±0.01% of rdg [±1 mV ±0.03% of rdg]	(20 µV + 0.0005% of rdg)/°C	±40 µV
<b>PTC RTD</b>	Positive	0 Ω to 10 Ω	1 mA <sup>12</sup>	0.1 mΩ	0.2 mΩ	±0.002 Ω ±0.01% of rdg [±0.002 Ω ±0.03% of rdg]	(0.01 mΩ + 0.001% of rdg)/°C	±0.4 mΩ
		0 Ω to 30 Ω	1 mA <sup>12</sup>	0.1 mΩ	0.2 mΩ	±0.002 Ω ±0.01% of rdg [±0.002 Ω ±0.03% of rdg]	(0.03 mΩ + 0.001% of rdg)/°C	±0.4 mΩ
		0 Ω to 100 Ω	1 mA <sup>12</sup>	1 mΩ	2 mΩ	±0.004 Ω ±0.01% of rdg [±0.004 Ω ±0.03% of rdg]	(0.1 mΩ + 0.001% of rdg)/°C	±4 mΩ
		0 Ω to 300 Ω	1 mA <sup>12</sup>	1 mΩ	2 mΩ	±0.004 Ω ±0.01% of rdg [±0.004 Ω ±0.03% of rdg]	(0.3 mΩ + 0.001% of rdg)/°C	±4 mΩ
		0 Ω to 1 kΩ	1 mA <sup>12</sup>	10 mΩ	20 mΩ	±0.04 Ω ±0.02% of rdg [±0.04 Ω ±0.04% of rdg]	(1 mΩ + 0.001% of rdg)/°C	±40 mΩ
		0 Ω to 3 kΩ	1 mA <sup>12</sup>	10 mΩ	20 mΩ	±0.04 Ω ±0.02% of rdg [±0.04 Ω ±0.04% of rdg]	(3 mΩ + 0.001% of rdg)/°C	±40 mΩ
		0 Ω to 10 kΩ	1 mA <sup>12</sup>	100 mΩ	200 mΩ	±0.4 Ω ±0.02% of rdg [±0.04 Ω ±0.04% of rdg]	(10 mΩ + 0.001% of rdg)/°C	±40 mΩ
<b>NTC RTD 10 mV</b>	Negative	0 Ω to 10 Ω	1 mA <sup>12</sup>	0.1 mΩ	0.15 mΩ	±0.002 Ω ±0.06% of rdg [±0.002 Ω ±0.08% of rdg]	(0.01 mΩ + 0.001% of rdg)/°C	±0.3 mΩ
		0 Ω to 30 Ω	300 µA <sup>12</sup>	0.1 mΩ	0.45 mΩ	±0.002 Ω ±0.06% of rdg [±0.002 Ω ±0.08% of rdg]	(0.03 mΩ + 0.0015% of rdg)/°C	±0.9 mΩ
		0 Ω to 100 Ω	100 µA <sup>12</sup>	1 mΩ	1.5 mΩ	±0.01 Ω ±0.04% of rdg [±0.01 Ω ±0.06% of rdg]	(0.1 mΩ + 0.001% of rdg)/°C	±3 mΩ
		0 Ω to 300 Ω	30 µA <sup>12</sup>	1 mΩ	4.5 mΩ	±0.01 Ω ±0.04% of rdg [±0.01 Ω ±0.06% of rdg]	(0.3 mΩ + 0.0015% of rdg)/°C	±9 mΩ
		0 Ω to 1 kΩ	10 µA <sup>12</sup>	10 mΩ	15 mΩ + 0.002% of rdg	±0.1 Ω ±0.04% of rdg [±0.1 Ω ±0.06% of rdg]	(1 mΩ + 0.001% of rdg)/°C	±30 mΩ ±0.004% of rdg
		0 Ω to 3 kΩ	3 µA <sup>12</sup>	10 mΩ	45 mΩ + 0.002% of rdg	±0.1 Ω ±0.04% of rdg [±0.1 Ω ±0.06% of rdg]	(3 mΩ + 0.0015% of rdg)/°C	±90 mΩ ±0.004% of rdg
		0 Ω to 10 kΩ	1 µA <sup>12</sup>	100 mΩ	150 mΩ + 0.002% of rdg	±1.0 Ω ±0.04% of rdg [±1.0 Ω ±0.06% of rdg]	(10 mΩ + 0.001% of rdg)/°C	±300 mΩ ±0.004% of rdg
		0 Ω to 30 kΩ	300 nA <sup>12</sup>	100 mΩ	450 mΩ + 0.002% of rdg	±2.0 Ω ±0.04% of rdg [±2.0 Ω ±0.06% of rdg]	(30 mΩ + 0.001% of rdg)/°C	±900 mΩ ±0.004% of rdg
		0 Ω to 100 kΩ	100 nA <sup>12</sup>	1 Ω	1.5 Ω + 0.005% of rdg	±10.0 Ω ±0.04% of rdg [±10.0 Ω ±0.06% of rdg]	(100 mΩ + 0.002% of rdg)/°C	±3 Ω ±0.01% of rdg
<b>Thermocouple option Model 3060</b>	Sensor temperature coefficient	Input range	Excitation current	Display resolution	Measurement resolution	Electronic accuracy (at 25 °C) <sup>8</sup>	Measurement temperature coefficient	Electronic control stability <sup>9</sup>
<b>Thermocouple 3060</b>	Positive	±50 mV	NA	0.1 µV	0.4 µV	±4.5 µV ±0.07% of rdg <sup>13</sup>	(0.1 µV + 0.001% of rdg)/°C	±0.8 µV
<b>Capacitance option Model 3061</b>	Sensor temperature coefficient	Input range	Excitation current	Display resolution	Measurement resolution	Electronic accuracy (at 25 °C) <sup>8</sup>	Measurement temperature coefficient	Electronic control stability <sup>9</sup>
<b>Capacitance 3061</b>	Positive or negative	0.1 nF to 15 nF	3.496 kHz 1 mA square wave	0.1 pF	0.05 pF	±50 pF ±0.1% of rdg	2.5 pF/°C	0.1 pF
		1 nF to 150 nF	3.496 kHz 10 mA square wave	1 pF	0.5 pF	±50 pF ±0.1% of rdg	5 pF/°C	1 pF

<sup>8</sup> With current reversal enabled for RTD measurements

<sup>9</sup> Control stability of the electronics only, in ideal thermal system

<sup>10</sup> Current source error has negligible effect on measurement accuracy

<sup>11</sup> Diode input excitation can be set to 1 mA

<sup>12</sup> Current source error is removed during calibration

<sup>13</sup> Accuracy specification does not include errors from room temperature compensation



## Sensor input configuration

	Diode/RTD	Thermocouple
<b>Measurement type</b>	4-lead differential	2-lead differential, room temperature compensated
<b>Excitation</b>	Constant current with current reversal for RTDs	NA
<b>Supported sensors</b>	<b>Diodes:</b> Silicon, GaAlAs <b>RTDs:</b> 100 Ω Platinum, 1000 Ω Platinum, Germanium, Carbon-Glass, Cernox <sup>®</sup> , and Rox <sup>™</sup>	Most thermocouple types
<b>Standard curves</b>	DT-470, DT-670, DT-500-D, DT-500-E1, PT-100, PT-1000, RX-102A, RX-202A	Type E, Type K, Type T, AuFe 0.07% vs. Cr, AuFe 0.03% vs. Cr
<b>Input connector</b>	6-pin DIN	Screw terminals in a ceramic isothermal block

## Thermometry

**Number of inputs** 4 (8 with scanner option)

**Input configuration** Inputs can be configured from the front panel to accept any of the supported input types. Thermocouple and capacitance inputs require an optional input card that can be installed in the field.

**Supported option cards** Thermocouple (3060), capacitance (3061), or scanner (3062)

**Option slots** 1

**Isolation** Sensor inputs optically isolated from other circuits but not each other

**A/D resolution** 24-bit

**Input accuracy** Sensor dependent, refer to Input Specifications table

**Measurement resolution** Sensor dependent, refer to Input Specifications table

**Maximum update rate** 10 rdg/s on each input, 5 rdg/s when configured as 100 kΩ NTC RTD with reversal on, 2 rdg/s on each scanned input (scanner option only)

**Autorange** Automatically selects appropriate NTC RTD or PTC RTD range

**User curves** Room for 39 200-point CalCurves<sup>™</sup> or user curves

**SoftCal<sup>™</sup>** Improves accuracy of DT-470 diode to ±0.25 K from 30 K to 375 K; improves accuracy of platinum RTDs to ±0.25 K from 70 K to 325 K; stored as user curves

**Math** Maximum and minimum

**Filter** Averages 2 to 64 input readings

## Control

**Control outputs** 4

### Heater outputs (Outputs 1 & 2)

**Control type** Closed loop digital PID with manual heater output or open loop

**Update rate** 10/s

**Tuning** Autotune (one loop at a time), PID, PID zones

**Control stability** Sensor dependent, see Input Specifications table

**PID control settings**

**Proportional (gain)** 0 to 1000 with 0.1 setting resolution

**Integral (reset)** 1 to 1000 (1000/s) with 0.1 setting resolution

**Derivative (rate)** 1 to 200% with 1% resolution

**Manual output** 0 to 100% with 0.01% setting resolution

**Zone control** 10 temperature zones with P, I, D, manual heater out, heater range, control channel, ramp rate

**Setpoint ramping** 0.1 K/min to 100 K/min

## Output 1

	25 Ω setting	50 Ω setting
<b>Type</b>	Variable DC current source	
<b>D/A resolution</b>	16-bit	
<b>Max power</b>	100 W	50 W
<b>Max current</b>	2 A	1 A
<b>Voltage compliance</b>	50 V	50 V
<b>Heater load for max power</b>	25 Ω	50 Ω
<b>Heater load range</b>	10 Ω to 100 Ω	
<b>Ranges</b>	3 (decade steps in power)	
<b>Heater noise</b>	0.12 μA RMS (dominated by line frequency and its harmonics)	
<b>Grounding</b>	Output referenced to chassis ground	
<b>Heater connector</b>	Dual banana	
<b>Safety limits</b>	Curve temperature, power up heater off, short circuit protection	

## Output 2

	25 Ω setting	50 Ω setting
<b>Type</b>	Variable DC current source	
<b>D/A resolution</b>	16-bit	
<b>Max power</b>	50 W	50 W
<b>Max current</b>	1.41 A	1 A
<b>Voltage compliance</b>	35.4 V	50 V
<b>Heater load for max power</b>	25 Ω	50 Ω
<b>Heater load range</b>	10 Ω to 100 Ω	
<b>Ranges</b>	3 (decade steps in power)	
<b>Heater noise</b>	0.12 μA RMS (dominated by line frequency and its harmonics)	
<b>Grounding</b>	Output referenced to chassis ground	
<b>Heater connector</b>	Dual banana	
<b>Safety limits</b>	Curve temperature, power up heater off, short circuit protection	

## Unpowered analog outputs (Outputs 3 & 4)

**Control type** Closed loop PID, PID zones, warm up heater mode, manual output, or monitor output

**Tuning** Autotune (one loop at a time), PID, PID zones

**Control stability** Sensor dependent, see Input Specifications table

**PID control settings**

**Proportional (gain)** 0 to 1000 with 0.1 setting resolution

**Integral (reset)** 1 to 1000 (1000/s) with 0.1 setting resolution

**Derivative (rate)** 1 to 200% with 1% resolution

**Manual output** 0 to 100% with 0.01% setting resolution

**Zone control** 10 temperature zones with P, I, D, manual heater out, heater range, control channel, ramp rate

**Setpoint ramping** 0.1 K/min to 100 K/min

**Warm up heater mode settings**

**Warm up percentage** 0 to 100% with 1% resolution

**Warm up mode** Continuous control or auto-off

**Monitor output settings**

**Scale** User selected

**Data source** Temperature or sensor units

**Settings** Input, source, top of scale, bottom of scale, or manual

**Type** Variable DC voltage source

**Update rate** 10/s

**Range** ±10 V

**Resolution** 16-bit, 0.3 mV

**Accuracy** ±2.5 mV

**Noise** 0.3 mV RMS

**Minimum load resistance** 1 kΩ (short-circuit protected)

**Connector** Detachable terminal block



## Front panel

**Display** 8-line by 40-character (240 × 64 pixel) graphic LCD display module with LED backlight

**Number of reading displays** 1 to 8

**Display units** K, °C, V, mV, Ω

**Reading source** Temperature, sensor units, max, and min

**Display update rate** 2 rdg/s

**Temperature display resolution** 0.0001° from 0° to 99.9999°, 0.001° from 100° to 999.999°, 0.01° above 1000°

**Sensor units display resolution** Sensor dependent, to 6 digits

**Other displays** Input name, setpoint, heater range, heater output, and PID

**Setpoint setting resolution** Same as display resolution (actual resolution is sensor dependent)

**Heater output display** Numeric display in percent of full scale for power or current

**Heater output resolution** 0.01%

**Display annunciators** Control input, alarm, tuning

**LED annunciators** Remote, Ethernet status, alarm, control outputs

**Keypad** 27-key silicone elastomer keypad

**Front panel features** Front panel curve entry, display contrast control, and keypad lock-out

## Interface

### IEEE-488.2

**Capabilities** SH1, AH1, T5, L4, SR1, RL1, PP0, DC1, DT0, C0, E1

**Reading rate** To 10 rdg/s on each input

**Software support** LabVIEW™ driver (see [www.lakeshore.com](http://www.lakeshore.com))

### USB

**Function** Emulates a standard RS-232 serial port

**Baud rate** 57,600

**Connector** B-type USB connector

**Reading rate** To 10 rdg/s on each input

**Software support** LabVIEW™ driver (see [www.lakeshore.com](http://www.lakeshore.com))

### Ethernet

**Function** TCP/IP, web interface, curve handler, configuration backup, chart recorder

**Connector** RJ-45

**Reading rate** To 10 rdg/s on each input

**Software support** LabVIEW™ driver (see [www.lakeshore.com](http://www.lakeshore.com))

### Alarms

**Number** 4, high and low for each input

**Data source** Temperature or sensor units

**Settings** Source, high setpoint, low setpoint, deadband, latching or non-latching, audible on/off, and visible on/off

**Actuators** Display annunciator, beeper, and relays

### Relays

**Number** 2

**Contacts** Normally open (NO), normally closed (NC), and common (C)

**Contact rating** 30 VDC at 3 A

**Operation** Activate relays on high, low, or both alarms for any input, or manual mode

**Connector** Detachable terminal block

## General

**Ambient temperature** 15 °C to 35 °C at rated accuracy; 5 °C to 40 °C at reduced accuracy

**Power requirement** 100, 120, 220, 240 VAC, ±10%, 50 or 60 Hz, 250 VA

**Size** 435 mm W × 89 mm H × 368 mm D (17 in × 3.5 in × 14.5 in), full rack

**Weight** 7.6 kg (16.8 lb)

**Approval** CE mark, RoHS

## Ordering information

### Part number Description

<b>336</b>	4 diode/RTD inputs and 4 control outputs, including one dual banana jack heater input connector (106-009), four 6-pin DIN plug sensor input mating connectors (G-106-233), one 10-pin terminal block (G-106-750), a calibration certificate and a user's manual
<b>336-3060</b>	Model 336 with a 3060 option card installed
<b>336-3061</b>	Model 336 with a 3061 option card installed
<b>336-3062</b>	Model 336 with a 3062 option card installed
<b>3060</b>	2-thermocouple input option, uninstalled
<b>3061</b>	Capacitance input option for 350/336, uninstalled
<b>3062</b>	4-channel scanner option for diodes and RTD sensors for 350/336, uninstalled

### Please indicate your power/cord configuration:

- 100 V—U.S. cord (NEMA 5-15)
- 120 V—U.S. cord (NEMA 5-15)
- 220 V—Euro cord (CEE 7/7)
- 240 V—Euro cord (CEE 7/7)
- 240 V—U.K. cord (BS 1363)
- 240 V—Swiss cord (SEV 1011)
- 220 V—China cord (GB 1002)

### Accessories

<b>112-177</b>	Temperature controller cable, 3 m (10 ft)—IN STOCK
<b>112-178</b>	Temperature controller cable, 6 m (20 ft)
<b>112-180</b>	Temperature controller cable, 10 m (33 ft)
<b>6201</b>	1 m (3.3 ft long) IEEE-488 (GPIB) computer interface cable assembly
<b>RM-1</b>	Rack mount kit for mounting one full rack temperature instrument
<b>G-106-233</b>	Sensor input mating connector (6-pin DIN plug)
<b>G-106-755</b>	Terminal block, 10-pin
<b>106-009</b>	Banana plug, dual
<b>CAL-336-CERT</b>	Instrument recalibration with certificate
<b>CAL-336-DATA</b>	Instrument recalibration with certificate and data
<b>CAL-3060-CERT</b>	Thermocouple board recalibration with certificate
<b>119-048</b>	Model 336 temperature controller manual

All specifications are subject to change without notice





# Model 335 Temperature Controller



## Model 335 features

- Operates down to 300 mK with appropriate NTC RTD sensors
- Two sensor inputs
- Two configurable PID control loops providing 50 W and 25 W or 75 W and 1 W
- Autotuning automatically calculates PID parameters
- Automatically switch sensor inputs using zones to allow continuous measurement and control from 300 mK to 1505 K
- Custom display set-up allows you to label each sensor input
- USB and IEEE-488 interfaces
- Supports diode, RTD, and thermocouple temperature sensors
- Sensor excitation current reversal eliminates thermal EMF errors for resistance sensors
- $\pm 10$  V analog voltage output, alarms, and relays
- CE certification
- Full 3 year standard warranty





## Introduction

Designed with the user and ease of use in mind, the Model 335 temperature controller offers many user-configurable features and advanced functions that until now have been reserved for more expensive, high-end temperature controllers. The Model 335 is the first two-channel temperature controller available with user configurable heater outputs delivering a total of 75 W of low noise heater power—50 W and 25 W, or 75 W and 1 W. With that much heater power packed into an affordable half-rack sized instrument, the Model 335 gives you more power and control than ever.

The Model 335 supports the industry's most advanced line of cryogenic temperature sensors as manufactured by Lake Shore, including diodes, resistance temperature detectors (RTDs), and thermocouples. The controller's zone tuning feature allows you to measure and control temperatures seamlessly from 300 mK to over 1,500 K. This feature automatically switches temperature sensor inputs when your temperature range goes beyond the useable range of a given sensor. You'll never again have to be concerned with temperature sensor over or under errors and measurement continuity issues.

As a replacement to our popular Model 331 and 332 temperature controllers, the Model 335 offers software emulation modes for literal drop-in compatibility. The commands you are accustomed to sending to the Model 331 and 332 will either be interpreted directly or translated to the most appropriate Model 335 setting. The Model 335 comes standard-equipped with all of the functionality of the controllers it replaces, but offers additional features that save you time and money.

With the Model 335, you get a temperature controller you control from the world leader in cryogenic thermometry.



Control outputs are equipped with both hardware and software features allowing you, and not your temperature controller, to easily control your experiments. Output one functions as a current output while output two can be configured in either current or voltage mode. With output two in voltage mode, it functions as a  $\pm 10$  V analog output while still providing 1 W of heater power and full closed loop proportional-integral-derivative (PID) control capability. Alarms and relays are included to help automate secondary control functions. The improved autotuning feature of the Model 335 can be used to automatically calculate PID control parameters, so you spend less time tuning your controller and more time conducting experiments.

The intuitive front panel layout and keypad logic, bright vacuum fluorescent display, and LED indicators enhance the user-friendly front panel interface of the Model 335. Four standard display modes are offered to accommodate different instrument configurations and user preferences. Say goodbye to sticky notes and hand written labels, as the ability to custom label sensor inputs eliminates the guesswork in remembering or determining the location to which a sensor input is associated. These features, combined with USB and IEEE-488 interfaces and intuitive menu structure and logic supports efficiency and ease of use.

## Sensor inputs

The Model 335 offers two standard sensor inputs that are compatible with diode and RTD temperature sensors. The field-installable Model 3060 option adds thermocouple functionality to both inputs.

Sensor inputs feature a high-resolution 24-bit analog-to-digital converter and each of the two powered outputs function as separate current sources. Both sensor inputs are optically isolated from other circuits to reduce noise and to deliver repeatable sensor measurements. Current reversal eliminates thermal electromagnetic field (EMF) errors in resistance sensors. Ten excitation currents facilitate temperature measurement and control down to 300 mK using appropriate negative temperature coefficient (NTC) RTDs. Autorange mode automatically scales excitation current in NTC RTDs to reduce self heating at low temperatures as sensor resistance changes by many orders of magnitude. Temperatures down to 1.4 K can be measured and controlled using silicon diodes. Software selects the appropriate excitation current and signal gain levels when the sensor type is entered via the instrument front panel. To increase your productivity, the unique zone setting feature automatically switches sensor inputs, enabling you to measure temperatures from 300 mK to over 1,500 K without interrupting your experiment.



The Model 335 includes standard temperature sensor response curves for silicon diodes, platinum RTDs, ruthenium oxide RTDs, and thermocouples. Non-volatile memory can also store up to 39 200-point CalCurves for Lake Shore calibrated temperature sensors or user curves. A built-in SoftCal algorithm can be used to generate curves for silicon diodes and platinum RTDs that can be stored as user curves. Temperature sensor calibration data can be easily loaded into the Model 335 temperature controller and manipulated using the Lake Shore curve handler software program.

### Temperature control

Providing a total of 75 W of heater power, the Model 335 is the most powerful half rack temperature controller available. Designed to deliver very clean heater power, precise temperature control is ensured throughout your full scale temperature range for excellent measurement reliability, efficiency and throughput. Two independent PID control outputs can be configured to supply 50 W and 25 W or 75 W and 1 W of heater power. Precise control output is calculated based on your temperature setpoint and feedback from the control sensor. Wide tuning parameters accommodate most cryogenic cooling systems and many high-temperature ovens commonly used in laboratories. PID values can be manually set for fine control or the improved autotuning feature can automate the tuning process.

The Model 335 autotuning method calculates PID parameters and provides feedback to help build zone tables. The setpoint ramp feature provides smooth, continuous setpoint changes and predictable approaches to setpoint without the worry of overshoot or excessive settling times. The instrument's zone tuning feature automatically switches temperature sensor inputs when your temperature range goes beyond the useable range of a given sensor. This feature combined with the instrument's ability to scale the sensor excitation through ten pre-loaded current settings allows the Model 335 to provide continuous measurement and control from 300 mK to 1505 K.

Both control outputs are variable DC current sources referenced to chassis ground. As a factory default, outputs 1 and 2 provide 50 W and 25 W of continuous power respectively, both to a 50  $\Omega$  or 25  $\Omega$  load. For increased functionality, output 2 can also be set to voltage mode. When set to voltage mode, it functions as a  $\pm 10$  V analog output while still providing 1 W of heater power and full closed loop PID control capability. While in this mode, output 1 can provide up to 75 W of heater power to a 25  $\Omega$  load.

Temperature limit settings for inputs are provided as a safeguard against system damage. Each input is assigned a temperature limit, and if any input exceeds that limit, both control channels are automatically disabled.

### Interface

The Model 335 is standard equipped with universal serial bus (USB) and parallel (IEEE-488) interfaces. In addition to gathering data, nearly every function of the instrument can be controlled via computer interface. You can download the Lake Shore curve handler software program to your computer to easily enter and manipulate sensor calibration curves for storage in the instrument's non-volatile memory.

The USB interface emulates an RS-232C serial port at a fixed 57,600 baud rate, but with the physical plug-ins of a USB. It also allows you to download firmware upgrades, ensuring the most current firmware version is loaded into your instrument without having to physically change your instrument.

Both sensor inputs are equipped with a high and low alarm which offers latching and non-latching operation. The two relays can be used in conjunction with the alarms to alert you of a fault condition and perform simple on-off control. Relays can be assigned to any alarm or operated manually.

The  $\pm 10$  V analog voltage output can be configured to send a voltage proportional to temperature to a strip chart recorder or data acquisition system. You may select the scale and data sent to the output, including temperature or sensor units.

### Model 335 rear panel

- 1 Sensor input connectors
- 2 Terminal block (analog outputs/relays)
- 3 USB interface
- 4 IEEE-488 interface
- 5 Line input assembly
- 6 Output 2 heater
- 7 Output 1 heater
- 8 Thermocouple option inputs

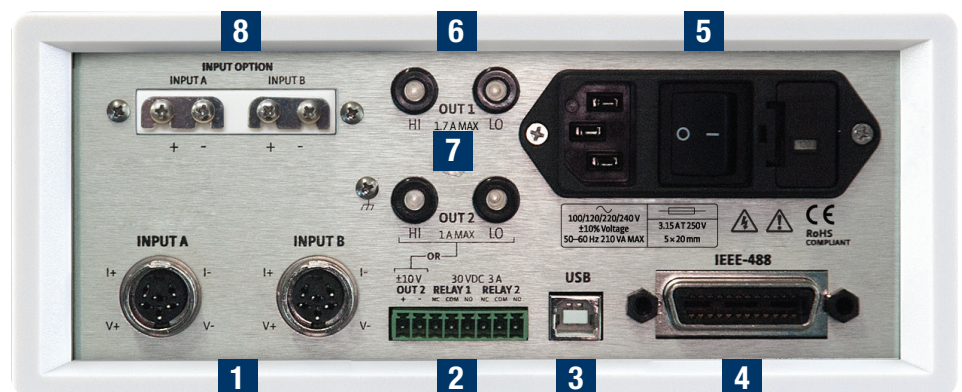



### Configurable display

The Model 335 offers a bright, vacuum fluorescent display that simultaneously displays up to four readings. You can display both control loops, or if you need to monitor just one input, you can display just that one in greater detail. Or you can custom configure each display location to suit your experiment. Data from any input can be assigned to any of the locations, and your choice of temperature sensor units can be displayed. For added convenience, you can also custom label each sensor input, eliminating the guesswork in remembering or determining the location to which a sensor input is associated.



#### Two input/one loop display with labels

Standard display option featuring two inputs and associated outputs.



#### Custom display with labels

Reading locations can be user configured to accommodate application needs. Here, the input names are shown above the measurement readings along with the designated input letters.



#### Intuitive menu structure

Logical navigation allows you to spend more time on research and less time on setup.

### Model 3060 thermocouple input option

The field installable Model 3060 thermocouple input option adds thermocouple functionality to both inputs. While the option can be easily removed, this is not necessary as the standard inputs remain fully functional when they are not being used to measure thermocouple temperature sensors. Calibration for the option is stored on the card so it can be installed in the field and used with multiple Model 335 temperature controllers without recalibration.

### Sensor selection

#### Sensor temperature range (sensors sold separately)

		Model	Useful range	Magnetic field use
<b>Diodes</b>	Silicon diode	DT-670-SD	1.4 K to 500 K	$T \geq 60 \text{ K} \ \& \ B \leq 3 \text{ T}$
	Silicon diode	DT-670E-BR	30 K to 500 K	$T \geq 60 \text{ K} \ \& \ B \leq 3 \text{ T}$
	Silicon diode	DT-414	1.4 K to 375 K	$T \geq 60 \text{ K} \ \& \ B \leq 3 \text{ T}$
	Silicon diode	DT-421	1.4 K to 325 K	$T \geq 60 \text{ K} \ \& \ B \leq 3 \text{ T}$
	Silicon diode	DT-470-SD	1.4 K to 500 K	$T \geq 60 \text{ K} \ \& \ B \leq 3 \text{ T}$
	Silicon diode	DT-471-SD	10 K to 500 K	$T \geq 60 \text{ K} \ \& \ B \leq 3 \text{ T}$
<b>Positive temperature coefficient RTDs</b>	100 $\Omega$ platinum	PT-102/3	14 K to 873 K	$T > 40 \text{ K} \ \& \ B \leq 2.5 \text{ T}$
	100 $\Omega$ platinum	PT-111	14 K to 673 K	$T > 40 \text{ K} \ \& \ B \leq 2.5 \text{ T}$
<b>Negative temperature coefficient RTDs</b>	Cernox <sup>®</sup>	CX-1010	0.3 K to 325 K <sup>1</sup>	$T > 2 \text{ K} \ \& \ B \leq 19 \text{ T}$
	Cernox <sup>®</sup>	CX-1030-HT	0.3 K to 420 K <sup>1,3</sup>	$T > 2 \text{ K} \ \& \ B \leq 19 \text{ T}$
	Cernox <sup>®</sup>	CX-1050-HT	1.4 K to 420 K <sup>1</sup>	$T > 2 \text{ K} \ \& \ B \leq 19 \text{ T}$
	Cernox <sup>®</sup>	CX-1070-HT	4 K to 420 K <sup>1</sup>	$T > 2 \text{ K} \ \& \ B \leq 19 \text{ T}$
	Cernox <sup>®</sup>	CX-1080-HT	20 K to 420 K <sup>1</sup>	$T > 2 \text{ K} \ \& \ B \leq 19 \text{ T}$
	Germanium	GR-300-AA	0.35 K to 100 K <sup>3</sup>	Not recommended
	Germanium	GR-1400-AA	1.8 K to 100 K <sup>3</sup>	Not recommended
Rox <sup>™</sup>	Rox <sup>™</sup>	RX-102	0.3 K to 40 K <sup>3</sup>	$T > 2 \text{ K} \ \& \ B \leq 10 \text{ T}$
	Rox <sup>™</sup>	RX-103	1.4 K to 40 K	$T > 2 \text{ K} \ \& \ B \leq 10 \text{ T}$
	Rox <sup>™</sup>	RX-202	0.3 K to 40 K <sup>3</sup>	$T > 2 \text{ K} \ \& \ B \leq 10 \text{ T}$
<b>Thermocouples</b>	Type K	9006-006	3.2 K to 1505 K	Not recommended
	Type E	9006-004	3.2 K to 934 K	Not recommended
<b>Option—3060</b>				
	Type E	9006-004	3.2 K to 934 K	Not recommended

<sup>1</sup> Non-HT version maximum temperature: 325 K

<sup>2</sup> Low temperature limited by input resistance range

<sup>3</sup> Low temperature specified with self-heating error:  $\leq 5 \text{ mK}$

**Silicon diodes** are the best choice for general cryogenic use from 1.4 K to above room temperature. Silicon diodes are economical to use because they follow a standard curve and are interchangeable in many applications. They are not suitable for use in ionizing radiation or magnetic fields.

**Cernox<sup>®</sup>** thin-film RTDs offer high sensitivity and low magnetic field-induced errors over the 0.3 K to 420 K temperature range. Cernox sensors require calibration.

**Platinum RTDs** offer high uniform sensitivity from 30 K to over 800 K. With excellent reproducibility, they are useful as thermometry standards. They follow a standard curve above 70 K and are interchangeable in many applications.





## Typical sensor performance

Example Lake Shore sensor		Temperature	Nominal resistance/voltage	Typical sensor sensitivity <sup>4</sup>	Measurement resolution: temperature equivalents	Electronic accuracy: temperature equivalents	Temperature accuracy including electronic accuracy, CalCurve™, and calibrated sensor	Electronic control stability <sup>5</sup> : temperature equivalents
Silicon diode	DT-670-CO-13 with 1.4H calibration	1.4 K	1.664 V	-12.49 mV/K	0.8 mK	±13 mK	±25 mK	±1.6 mK
		77 K	1.028 V	-1.73 mV/K	5.8 mK	±76 mK	±98 mK	±11.6 mK
		300 K	0.5596 V	-2.3 mV/K	4.3 mK	±47 mK	±79 mK	±8.7 mK
		500 K	0.0907 V	-2.12 mV/K	4.7 mK	±40 mK	±90 mK	±9.4 mK
Silicon diode	DT-470-SD-13 with 1.4H calibration	1.4 K	1.6981 V	-13.1 mV/K	0.8 mK	±13 mK	±25 mK	±1.6 mK
		77 K	1.0203 V	-1.92 mV/K	5.2 mK	±68 mK	±90 mK	±10.4 mK
		300 K	0.5189 V	-2.4 mV/K	4.2 mK	±44 mK	±76 mK	±8.4 mK
100 Ω platinum RTD 500 Ω full scale	PT-103 with 14J calibration	30 K	3.660 Ω	0.191 Ω/K	1.1 mK	±13 mK	±23 mK	±2.2 mK
		77 K	20.38 Ω	0.423 Ω/K	0.5 mK	±10 mK	±22 mK	±1.0 mK
		300 K	110.35 Ω	0.387 Ω/K	5.2 mK	±39 mK	±62 mK	±10.4 mK
		500 K	185.668 Ω	0.378 Ω/K	5.3 mK	±60 mK	±106 mK	±10.6 mK
Cernox®	CX-1010-SD with 0.3L calibration	0.3 K	2322.4 Ω	-10785 Ω/K	8.5 μK	±0.1 mK	±3.6 mK	±17 μK
		0.5 K	1248.2 Ω	-2665.2 Ω/K	26 μK	±0.2 mK	±4.7 mK	±52 μK
		4.2 K	277.32 Ω	-32.209 Ω/K	140 μK	±3.8 mK	±8.8 mK	±280 μK
		300 K	30.392 Ω	-0.0654 Ω/K	23 mK	±339 mK	±414 mK	±46 mK
Cernox®	CX-1050-SD-HT <sup>6</sup> with 1.4M calibration	1.4 K	26566 Ω	-48449 Ω/K	20 μK	±0.3 mK	±5.3 mK	±40 μK
		4.2 K	3507.2 Ω	-1120.8 Ω/K	196 μK	±2.1 mK	±7.1 mK	±392 μK
		77 K	205.67 Ω	-2.4116 Ω/K	1.9 mK	±38 mK	±54 mK	±3.8 mK
Germanium	GR-300-AA with 0.3D calibration	0.35 K	18225 Ω	-193453 Ω/K	4 μK	±48 μK	±4.2 mK	±8 μK
		1.4 K	449 Ω	-581 Ω/K	41 μK	±481 μK	±4.7 mK	±82 μK
		4.2 K	94 Ω	-26.6 Ω/K	56 μK	±1.8 mK	±6.8 mK	±112 μK
		100 K	2.7 Ω	-0.024 Ω/K	6.3 mK	±152 mK	±175 mK	±12.6 mK
Germanium	GR-1400-AA with 1.4D calibration	1.8 K	15288 Ω	-26868 Ω/K	28 μK	±302 μK	±4.5 mK	±56 μK
		4.2 K	1689 Ω	-862 Ω/K	91 μK	±900 μK	±5.1 mK	±182 μK
		10 K	253 Ω	-62.0 Ω/K	73 μK	±1.8 mK	±6.8 mK	±146 μK
		100 K	2.8 Ω	-0.021 Ω/K	7.1 mK	±177 mK	±200 mK	±14.2 mK
Rox™	RX-102A-AA with 0.3B calibration	0.5 K	3701 Ω	-5478 Ω/K	41 μK	±0.5 mK	±5 mK	±82 μK
		1.4 K	2005 Ω	-667 Ω/K	128 μK	±1.4 mK	±6.4 mK	±256 μK
		4.2 K	1370 Ω	-80.3 Ω/K	902 μK	±8 mK	±24 mK	±1.8 mK
		40 K	1049 Ω	-1.06 Ω/K	62 mK	±500 mK	±537 mK	±124 mK
Thermocouple 50 mV Option—3060	Type K	75 K	-5862.9 μV	15.6 μV/K	26 mK	±0.25 K <sup>7</sup>	Calibration not available from Lake Shore	±52 mK
		300 K	1075.3 μV	40.6 μV/K	10 mK	±0.038 K <sup>7</sup>		±20 mK
		600 K	13325 μV	41.7 μV/K	10 mK	±0.184 K <sup>7</sup>		±20 mK
		1505 K	49998.3 μV	36.006 μV/K	11 mK	±0.73 K <sup>7</sup>		±22 mK

<sup>4</sup> Typical sensor sensitivities were taken from representative calibrations for the sensor listed<sup>5</sup> Control stability of the electronics only, in an ideal thermal system<sup>6</sup> Non-HT version maximum temperature: 325 K<sup>7</sup> Accuracy specification does not include errors from room temperature compensation



## Model 335 Specifications

### Input specifications

Sensor temperature coefficient		Input range	Excitation current	Display resolution	Measurement resolution	Electronic accuracy <sup>6</sup>	Measurement temperature coefficient	Electronic control stability <sup>1</sup>
Diode	Negative	0 V to 2.5 V	10 $\mu$ A $\pm$ 0.05% <sup>2,3</sup>	100 $\mu$ V	10 $\mu$ V	$\pm$ 80 $\mu$ V $\pm$ 0.005% of rdg	(10 $\mu$ V + 0.0005% of rdg)/ $^{\circ}$ C	$\pm$ 20 $\mu$ V
		0 V to 10 V	10 $\mu$ A $\pm$ 0.05% <sup>2,3</sup>	1 mV	20 $\mu$ V	$\pm$ 320 $\mu$ V $\pm$ 0.01% of rdg	(20 $\mu$ V + 0.0005% of rdg)/ $^{\circ}$ C	$\pm$ 40 $\mu$ V
PTC RTD	Positive	0 $\Omega$ to 10 $\Omega$	1 mA <sup>4</sup>	1 m $\Omega$	0.2 m $\Omega$	$\pm$ 0.002 $\Omega$ $\pm$ 0.01% of rdg	(0.01 m $\Omega$ + 0.001% of rdg)/ $^{\circ}$ C	$\pm$ 0.4 m $\Omega$
		0 $\Omega$ to 30 $\Omega$	1 mA <sup>4</sup>	1 m $\Omega$	0.2 m $\Omega$	$\pm$ 0.002 $\Omega$ $\pm$ 0.01% of rdg	(0.03 m $\Omega$ + 0.001% of rdg)/ $^{\circ}$ C	$\pm$ 0.4 m $\Omega$
		0 $\Omega$ to 100 $\Omega$	1 mA <sup>4</sup>	10 m $\Omega$	2 m $\Omega$	$\pm$ 0.004 $\Omega$ $\pm$ 0.01% of rdg	(0.1 m $\Omega$ + 0.001% of rdg)/ $^{\circ}$ C	$\pm$ 4 m $\Omega$
		0 $\Omega$ to 300 $\Omega$	1 mA <sup>4</sup>	10 m $\Omega$	2 m $\Omega$	$\pm$ 0.004 $\Omega$ $\pm$ 0.01% of rdg	(0.3 m $\Omega$ + 0.001% of rdg)/ $^{\circ}$ C	$\pm$ 4 m $\Omega$
		0 $\Omega$ to 1 k $\Omega$	1 mA <sup>4</sup>	100 m $\Omega$	20 m $\Omega$	$\pm$ 0.04 $\Omega$ $\pm$ 0.02% of rdg	(1 m $\Omega$ + 0.001% of rdg)/ $^{\circ}$ C	$\pm$ 40 m $\Omega$
		0 $\Omega$ to 3 k $\Omega$	1 mA <sup>4</sup>	100 m $\Omega$	20 m $\Omega$	$\pm$ 0.04 $\Omega$ $\pm$ 0.02% of rdg	(3 m $\Omega$ + 0.001% of rdg)/ $^{\circ}$ C	$\pm$ 40 m $\Omega$
		0 $\Omega$ to 10 k $\Omega$	1 mA <sup>4</sup>	1 $\Omega$	200 m $\Omega$	$\pm$ 0.4 $\Omega$ $\pm$ 0.02% of rdg	(10 m $\Omega$ + 0.001% of rdg)/ $^{\circ}$ C	$\pm$ 400 m $\Omega$
		0 $\Omega$ to 10 $\Omega$	1 mA <sup>4</sup>	1 m $\Omega$	0.15 m $\Omega$	$\pm$ 0.002 $\Omega$ $\pm$ 0.06% of rdg	(0.01 m $\Omega$ + 0.001% of rdg)/ $^{\circ}$ C	$\pm$ 0.3 m $\Omega$
NTC RTD 10 mV	Negative	0 $\Omega$ to 30 $\Omega$	300 $\mu$ A <sup>4</sup>	1 m $\Omega$	0.45 m $\Omega$	$\pm$ 0.002 $\Omega$ $\pm$ 0.06% of rdg	(0.03 m $\Omega$ + 0.0015% of rdg)/ $^{\circ}$ C	$\pm$ 0.9 m $\Omega$
		0 $\Omega$ to 100 $\Omega$	100 $\mu$ A <sup>4</sup>	10 m $\Omega$	1.5 m $\Omega$	$\pm$ 0.01 $\Omega$ $\pm$ 0.04% of rdg	(0.1 m $\Omega$ + 0.001% of rdg)/ $^{\circ}$ C	$\pm$ 3 m $\Omega$
		0 $\Omega$ to 300 $\Omega$	30 $\mu$ A <sup>4</sup>	10 m $\Omega$	4.5 m $\Omega$	$\pm$ 0.01 $\Omega$ $\pm$ 0.04% of rdg	(0.3 m $\Omega$ + 0.0015% of rdg)/ $^{\circ}$ C	$\pm$ 9 m $\Omega$
		0 $\Omega$ to 1 k $\Omega$	10 $\mu$ A <sup>4</sup>	100 m $\Omega$	15 m $\Omega$ +0.002% of rdg	$\pm$ 0.1 $\Omega$ $\pm$ 0.04% of rdg	(1 m $\Omega$ + 0.001% of rdg)/ $^{\circ}$ C	$\pm$ 30 m $\Omega$ $\pm$ 0.004% of rdg
		0 $\Omega$ to 3 k $\Omega$	3 $\mu$ A <sup>4</sup>	100 m $\Omega$	45 m $\Omega$ +0.002% of rdg	$\pm$ 0.1 $\Omega$ $\pm$ 0.04% of rdg	(3 m $\Omega$ + 0.0015% of rdg)/ $^{\circ}$ C	$\pm$ 90 m $\Omega$ $\pm$ 0.004% of rdg
		0 $\Omega$ to 10 k $\Omega$	1 $\mu$ A <sup>4</sup>	1 $\Omega$	150 m $\Omega$ +0.002% of rdg	$\pm$ 1.0 $\Omega$ $\pm$ 0.04% of rdg	(10 m $\Omega$ + 0.001% of rdg)/ $^{\circ}$ C	$\pm$ 300 m $\Omega$ $\pm$ 0.004% of rdg
		0 $\Omega$ to 30 k $\Omega$	300 nA <sup>4</sup>	1 $\Omega$	450 m $\Omega$ +0.002% of rdg	$\pm$ 2.0 $\Omega$ $\pm$ 0.04% of rdg	(30 m $\Omega$ + 0.0015% of rdg)/ $^{\circ}$ C	$\pm$ 900 m $\Omega$ $\pm$ 0.004% of rdg
		0 $\Omega$ to 100 k $\Omega$	100 nA <sup>4</sup>	10 $\Omega$	1.5 $\Omega$ +0.005% of rdg	$\pm$ 10.0 $\Omega$ $\pm$ 0.04% of rdg	(100 m $\Omega$ + 0.002% of rdg)/ $^{\circ}$ C	$\pm$ 3 $\Omega$ $\pm$ 0.01% of rdg
Thermocouple Option—3060	Positive	$\pm$ 50 mV	NA	1 $\mu$ V	0.4 $\mu$ V	$\pm$ 4.5 $\mu$ V $\pm$ 0.07% of rdg <sup>5</sup>	(0.1 $\mu$ V + 0.001% of rdg)/ $^{\circ}$ C	$\pm$ 0.8 $\mu$ V

<sup>1</sup> Control stability of the electronics only, in ideal thermal system

<sup>2</sup> Current source error has negligible effect on measurement accuracy

<sup>3</sup> Diode input excitation can be set to 1 mA

<sup>4</sup> Current source error is removed during calibration

<sup>5</sup> Accuracy specification does not include errors from room temperature compensation

<sup>6</sup> Accuracy at T<sub>cal</sub>, typically 23.5  $^{\circ}$ C  $\pm$ 1.5  $^{\circ}$ C; with current reversal enabled for RTD measurements

### Sensor input configuration

	Diode/RTD	Thermocouple
Measurement type	4-lead differential	2-lead differential, room temperature compensated
Excitation	Constant current with current reversal for RTDs	NA
Supported sensors	<b>Diodes:</b> Silicon, GaAlAs <b>RTDs:</b> 100 $\Omega$ Platinum, 1000 $\Omega$ Platinum, Germanium, Carbon-Glass, Cernox <sup>®</sup> , and Rox <sup>™</sup>	Most thermocouple types
Standard curves	DT-470, DT-670, DT-500-D, DT-500-E1, PT-100, PT-1000, RX-102A, RX-202A	Type E, Type K, Type T, AuFe 0.07% vs. Cr, AuFe 0.03% vs. Cr
Input connector	6-pin DIN	Screw terminals in a ceramic isothermal block

### Thermometry

**Number of inputs** 2

**Input configuration** Inputs can be configured from the front panel to accept any of the supported input types. Thermocouple inputs require an optional input card that can be installed in the field. Once installed the thermocouple input can be selected from the front panel like any other input type.

**Isolation** Sensor inputs optically isolated from other circuits but not each other

**A/D resolution** 24-bit

**Input accuracy** Sensor dependent, refer to Input Specifications table

**Measurement resolution** Sensor dependent, refer to Input Specifications table

**Maximum update rate** 10 rdg/s on each input, 5 rdg/s when configured as 100 k $\Omega$  NTC RTD with reversal on

**Autorange** Automatically selects appropriate NTC RTD or PTC RTD range

**User curves** Room for 39 200-point CalCurves<sup>™</sup> or user curves

**SoftCal<sup>™</sup>** Improves accuracy of DT-470 diode to  $\pm$ 0.25 K from 30 K to 375 K; improves accuracy of platinum RTDs to  $\pm$ 0.25 K from 70 K to 325 K; stored as user curves

**Math** Maximum and minimum

**Filter** Averages 2 to 64 input readings

### Control

**Control outputs** 2

### Heater outputs

**Control type** Closed loop digital PID with manual heater output or open loop; warm up mode (output 2 only)

**Update rate** 10/s

**Tuning** Autotune (one loop at a time), PID, PID zones

**Control stability** Sensor dependent, see Input Specifications table

**PID control settings**

**Proportional (gain)** 0 to 1000 with 0.1 setting resolution

**Integral (reset)** 1 to 1000 (1000/s) with 0.1 setting resolution

**Derivative (rate)** 1 to 200% with 1% resolution

**Manual output** 0 to 100% with 0.01% setting resolution

**Zone control** 10 temperature zones with P, I, D, manual heater out, heater range, control channel, ramp rate

**Setpoint ramping** 0.1 K/min to 100 K/min

**Warm up heater mode settings (output 2 only)**

**Warm up percentage** 0 to 100% with 1% resolution

**Warm up mode** Continuous control or auto-off

**Monitor output settings (output 2 voltage only)**

**Scale** User selected

**Data source** Temperature or sensor units

**Settings** Input, source, top of scale, bottom of scale, or manual



## Output 1

Type	Variable DC current source		
Control modes	Closed loop digital PID with manual output or open loop		
D/A resolution	16-bit		
	25 $\Omega$ setting	50 $\Omega$ setting	50 $\Omega$ setting
Max power	75 W*	50 W	50 W
Max current	1.73 A	1.41 A	1 A
Voltage compliance (min)	43.3 V	35.4 V	50 V
Heater load for max power	25 $\Omega$	25 $\Omega$	50 $\Omega$
Heater load range	10 $\Omega$ to 100 $\Omega$		
Ranges	3 (decade steps in power)		
Heater noise	0.12 $\mu$ A RMS (dominated by line frequency and its harmonics)		
Heater connector	Dual banana		
Grounding	Output referenced to chassis ground		
Safety limits	Curve temperature, power up heater off, short circuit protection		

\*75 W only available when output 2 is in voltage mode

## Output 2

Type	Variable DC current source or voltage source		
	Current mode	Voltage mode	
Control modes	Closed loop digital PID with manual output, zone, open loop	Closed loop digital PID with manual output, zone, open loop, warm up, monitor out	
D/A resolution	15-bit	16-bit (bipolar)/15-bit (unipolar)	
	25 $\Omega$ setting	50 $\Omega$ setting	N/A
Max power	25 W	25 W	1 W
Max current	1 A	0.71 A	100 mA
Voltage compliance (min)	25 V	35.4 V	$\pm$ 10 V
Heater load for max power	25 $\Omega$	50 $\Omega$	100 $\Omega$
Heater load range	10 $\Omega$ to 100 $\Omega$		100 $\Omega$ min (short circuit protected)
Ranges	3 (decade steps in power)		N/A
Heater noise	0.12 $\mu$ A RMS		0.3 mV RMS
Heater connector	Dual banana		Detachable terminal block
Grounding	Output referenced to chassis ground		
Safety limits	Curve temperature, power up heater off, short circuit protection		

**Update rate** 10/s

**Range**  $\pm$ 10 V

**Resolution** 16-bit, 0.3 mV

**Accuracy**  $\pm$ 2.5 mV

**Noise** 0.3 mV RMS

**Minimum load resistance** 100  $\Omega$  (short-circuit protected)

**Connector** Detachable terminal block

## Front panel

**Display** 2-line by 20-character, 9 mm character height, vacuum fluorescent display

**Number of reading displays** 1 to 4

**Display units** K,  $^{\circ}$ C, V, mV,  $\Omega$

**Reading source** Temperature, sensor units, max, and min

**Display update rate** 2 rdg/s

**Temperature display resolution** 0.001 $^{\circ}$  from 0 $^{\circ}$  to 99.999 $^{\circ}$ , 0.01 $^{\circ}$  from 100 $^{\circ}$  to 999.99 $^{\circ}$ , 0.1 $^{\circ}$  above 1000 $^{\circ}$

**Sensor units display resolution** Sensor dependent, to 5 digits

**Other displays** Sensor name, setpoint, heater range, heater output, and PID

**Setpoint setting resolution** Same as display resolution (actual resolution is sensor dependent)

**Heater output display** Numeric display in percent of full scale for power or current

**Heater output resolution** 1%

**Display annunciators** Control input, alarm, tuning

**LED annunciators** Remote, alarm, control outputs

**Keypad** 25-key silicone elastomer keypad

**Front panel features** Front panel curve entry, display brightness control, and keypad lock-out

## Interface

### IEEE-488.2

**Capabilities** SH1, AH1, T5, L4, SR1, RL1, PP0, DC1, DT0, C0, E1

**Reading rate** To 10 rdg/s on each input

**Software support** LabVIEW™ driver (see www.lakeshore.com)

### USB

**Function** Emulates a standard RS-232 serial port

**Baud rate** 57,600

**Connector** B-type USB connector

**Reading rate** To 10 rdg/s on each input

**Software support** LabVIEW™ driver (see www.lakeshore.com)

**Special interface features** Model 331/332 command emulation mode

### Alarms

**Number** 2, high and low for each input

**Data source** Temperature or sensor units

**Settings** Source, high setpoint, low setpoint, deadband, latching or non-latching, audible on/off, and visible on/off

**Actuators** Display annunciator, beeper, and relays

### Relays

**Number** 2

**Contacts** Normally open (NO), normally closed (NC), and common (C)

**Contact rating** 30 VDC at 3 A

**Operation** Activate relays on high, low, or both alarms for any input, or manual mode

**Connector** Detachable terminal block

## General

**Ambient temperature** 15  $^{\circ}$ C to 35  $^{\circ}$ C at rated specifications; 5  $^{\circ}$ C to 40  $^{\circ}$ C at reduced specifications

**Power requirement** 100, 120, 220, 240 VAC,  $\pm$ 10%, 50 or 60 Hz, 210 VA

**Size** 217 mm W  $\times$  90 mm H  $\times$  317 mm D (8.5 in  $\times$  3.5 in  $\times$  14.5 in), half rack

**Weight** 5.1 kg (11.3 lb)

**Approval** CE mark, RoHS

## Ordering information

### Part number Description

<b>335</b>	2 diode/RTD inputs and 2 control outputs temperature controller—includes one dual banana jack heater output connector (106-009), two 6-pin DIN plug sensor input mating connectors (G-106-233), one 8-pin terminal block (G-107-773), a calibration certificate and user manual
<b>335-3060</b>	Model 335 with 3060 option card installed
<b>3060</b>	2-thermocouple input option for Model 335, uninstalled

### Please indicate your power/cord configuration:

- 1 100 V—U.S. cord (NEMA 5-15)
- 2 120 V—U.S. cord (NEMA 5-15)
- 3 220 V—Euro cord (CEE 7/7)
- 4 240 V—Euro cord (CEE 7/7)
- 5 240 V—U.K. cord (BS 1363)
- 6 240 V—Swiss cord (SEV 1011)
- 7 220 V—China cord (GB 1002)

## Accessories

<b>112-177</b>	Temperature controller cable, 3 m (10 ft)—IN STOCK
<b>112-178</b>	Temperature controller cable, 6 m (20 ft)
<b>112-180</b>	Temperature controller cable, 10 m (33 ft)
<b>6201</b>	1 m (3.3 ft long) IEEE-488 (GPIB) computer interface cable assembly
<b>RM-2</b>	Kit for mounting two 1/2-rack temperature instruments in a 483 mm (19 in) rack
<b>RM-1/2</b>	Kit for mounting one 1/2-rack temperature instrument in a 483 mm (19 in) rack
<b>G-106-233</b>	Sensor input mating connector (6-pin DIN plug)
<b>G-106-773</b>	Terminal block, 8-pin
<b>106-009</b>	Banana plug, dual
<b>CAL-335-CERT</b>	Instrument recalibration with certificate
<b>CAL-335-DATA</b>	Instrument recalibration with certificate and data
<b>119-055</b>	Model 335 temperature controller manual

All specifications are subject to change without notice





## Model 325 Temperature Controller



### Model 325 features

- Operates down to 1.2 K with appropriate sensor
- Two sensor inputs
- Supports diode, RTD, and thermocouple sensors
- Sensor excitation current reversal eliminates thermal EMF errors in resistance sensors
- Two autotuning control loops: 25 W and 2 W maximum
- Control loop 2: variable DC voltage source from 0 to 10 V maximum
- IEEE-488 and RS-232C interfaces
- CE certification
- Full 3 year standard warranty





## Introduction

The Model 325 dual-channel temperature controller is capable of supporting nearly any diode, RTD, or thermocouple temperature sensor. Two independent PID control loops with heater outputs of 25 W and 2 W are configured to drive either a 50  $\Omega$  or 25  $\Omega$  load for optimal cryocooler control flexibility. Designed with ease of use, functionality, and value in mind, the Model 325 is ideal for general-purpose laboratory and industrial temperature measurement and control applications.

## Sensor inputs

The Model 325 temperature controller features two inputs with a high-resolution 24-bit analog-to-digital converter and separate current sources for each input. Constant current excitation allows temperature to be measured and controlled down to 2.0 K using appropriate Cernox<sup>®</sup> RTDs or down to 1.4 K using silicon diodes. Thermocouples allow for temperature measurement and control above 1,500 K. Sensors are optically isolated from other instrument functions for quiet and repeatable sensor measurements. The Model 325 also uses current reversal to eliminate thermal EMF errors in resistance sensors. Sensor data from each input is updated up to ten times per second, with display outputs twice each second.

Standard temperature response curves for silicon diodes, platinum RTDs, ruthenium oxide RTDs, and many thermocouples are included. Up to fifteen 200-point CalCurves<sup>™</sup> (for Lake Shore calibrated temperature sensors) or user curves can be stored into non-volatile memory. A built-in SoftCal<sup>™</sup> algorithm can be used to generate curves for silicon diodes and platinum RTDs for storage as user curves. The Lake Shore curve handler software program allows sensor curves to be easily loaded and manipulated.

Sensor inputs for the Model 325 are factory configured and compatible with either diodes/RTDs or thermocouple sensors. Your choice of two diode/RTD inputs, one diode/RTD input and one thermocouple input, or two thermocouple inputs must be specified at time of order and cannot be reconfigured in the field. Software selects appropriate excitation current and signal gain levels when the sensor type is entered via the instrument front panel.

## Temperature control

The Model 325 temperature controller offers two independent proportional-integral-derivative (PID) control loops. A PID algorithm calculates control output based on temperature setpoint and feedback from the control sensor. Wide tuning parameters accommodate most cryogenic cooling systems and many small high-temperature ovens. A high-resolution digital-to-analog converter generates a smooth control

output. The user can set the PID values or the Autotuning feature of the Model 325 can automate the tuning process.

Control loop 1 heater output for the Model 325 is a well-regulated variable DC current source. The output can provide up to 25 W of continuous power to a 50  $\Omega$  or 25  $\Omega$  heater load, and includes a lower range for systems with less cooling power. Control loop 2 heater output is a single-range, variable DC voltage source. The output can source up to 0.2 A, providing 2 W of heater power at the 50  $\Omega$  setting or 1 W at the 25  $\Omega$  setting. When not being used for temperature control, the loop 2 heater output can be used as a manually controlled voltage source. The output voltage can vary from 0 to 10 V on the 50  $\Omega$  setting, or 0 to 5 V on the 25  $\Omega$  setting. Both heater outputs are referenced to chassis ground.

The setpoint ramp feature allows smooth continuous setpoint changes and can also make the approach to setpoint more predictable. The zone feature can automatically change control parameter values for operation over a large temperature range. Ten different temperature zones can be loaded into the instrument, which will select the next appropriate value on setpoint change.

Temperature limit settings for inputs are provided as a safeguard against system damage<sup>1</sup>. Each input is assigned a temperature limit, and if any input exceeds that limit, all control channels are automatically disabled.

<sup>1</sup> Firmware version 1.5 and later

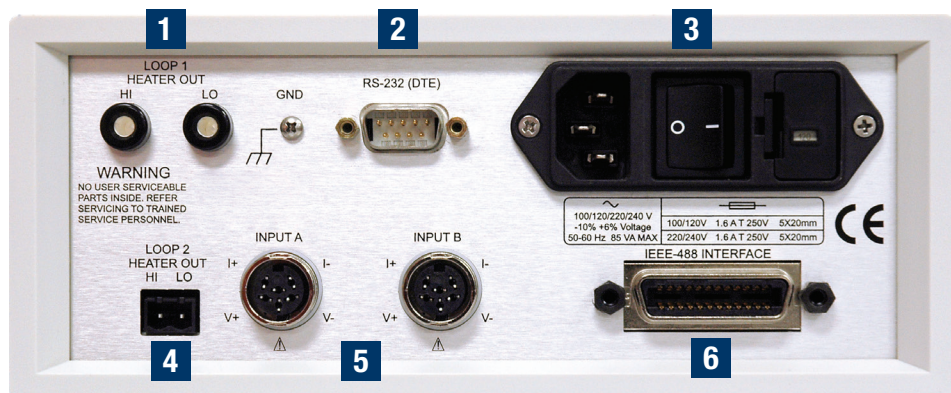

## Model 325 rear panel

- |   |                            |   |                         |
|---|----------------------------|---|-------------------------|
| 1 | Loop 1 heater output       | 4 | Loop 2 heater output    |
| 2 | Serial (RS-232C) I/O (DTE) | 5 | Sensor input connectors |
| 3 | Line input assembly        | 6 | IEEE-488 interface      |



## Interface

The Model 325 includes both parallel (IEEE-488) and serial (RS-232C) computer interfaces. In addition to data gathering, nearly every function of the instrument can be controlled via computer interface. Sensor curves can also be entered and manipulated through either interface using the Lake Shore curve handler software program.

### Normal (default) display configuration

The display provides four reading locations. Readings from each input and the control setpoint can be expressed in any combination of temperature or sensor units, with heater output expressed as a percent of full scale current or power.

### Flexible configuration

Reading locations can be configured by the user to meet application needs. The character preceding the reading indicates input A or B or setpoint S. The character following the reading indicates measurement units.

### Curve entry

The Model 325 display offers the flexibility to support curve, SoftCal™, and zone entry. Curve entry may be performed accurately and to full resolution via the display and keypad as well as computer interface.

## Configurable display

The Model 325 offers a bright, easy to read LCD display that simultaneously displays up to four readings. Display data includes input and source annunciators for each reading. All four display locations can be configured by the user. Data from either input can be assigned to any of the four locations, and the user's choice of temperature or sensor units can be displayed. Heater range and control output as current or power can be continuously displayed for immediate feedback on control operation. The channel A or B indicator is underlined to indicate which channel is being controlled by the displayed control loop.

## Sensor Selection

### Sensor temperature range (sensors sold separately)

		Model	Useful range	Magnetic field use
Diodes	Silicon diode	DT-670-SD	1.4 K to 500 K	$T \geq 60 \text{ K} \ \& \ B \leq 3 \text{ T}$
	Silicon diode	DT-670E-BR	30 K to 500 K	$T \geq 60 \text{ K} \ \& \ B \leq 3 \text{ T}$
	Silicon diode	DT-414	1.4 K to 375 K	$T \geq 60 \text{ K} \ \& \ B \leq 3 \text{ T}$
	Silicon diode	DT-421	1.4 K to 325 K	$T \geq 60 \text{ K} \ \& \ B \leq 3 \text{ T}$
	Silicon diode	DT-470-SD	1.4 K to 500 K	$T \geq 60 \text{ K} \ \& \ B \leq 3 \text{ T}$
	Silicon diode	DT-471-SD	10 K to 500 K	$T \geq 60 \text{ K} \ \& \ B \leq 3 \text{ T}$
Positive temperature coefficient RTDs	100 $\Omega$ platinum	PT-102/3	14 K to 873 K	$T > 40 \text{ K} \ \& \ B \leq 2.5 \text{ T}$
	100 $\Omega$ platinum	PT-111	14 K to 673 K	$T > 40 \text{ K} \ \& \ B \leq 2.5 \text{ T}$
Negative temperature coefficient RTDs <sup>2</sup>	Cernox®	CX-1010	2 K to 325 K <sup>5</sup>	$T > 2 \text{ K} \ \& \ B \leq 19 \text{ T}$
	Cernox®	CX-1030-HT	3.5 K to 420 K <sup>3,6</sup>	$T > 2 \text{ K} \ \& \ B \leq 19 \text{ T}$
	Cernox®	CX-1050-HT	4 K to 420 K <sup>3,6</sup>	$T > 2 \text{ K} \ \& \ B \leq 19 \text{ T}$
	Cernox®	CX-1070-HT	15 K to 420 K <sup>3</sup>	$T > 2 \text{ K} \ \& \ B \leq 19 \text{ T}$
	Cernox®	CX-1080-HT	50 K to 420 K <sup>3</sup>	$T > 2 \text{ K} \ \& \ B \leq 19 \text{ T}$
	Germanium	GR-300-AA	1.2 K to 100 K <sup>4</sup>	Not recommended
Thermocouples	Type K	9006-006	3.2 K to 1505 K	Not recommended
	Type E	9006-004	3.2 K to 934 K	Not recommended

<sup>2</sup> Single excitation current may limit the low temperature range of NTC resistors

<sup>3</sup> Non-HT version maximum temperature: 325 K

<sup>4</sup> Low temperature limited by input resistance range

<sup>5</sup> Low temperature specified with self-heating error:  $\leq 5 \text{ mK}$

<sup>6</sup> Low temperature specified with self-heating error:  $\leq 12 \text{ mK}$

**Silicon diodes** are the best choice for general cryogenic use from 1.4 K to above room temperature. Diodes are economical to use because they follow a standard curve and are interchangeable in many applications. They are not suitable for use in ionizing radiation or magnetic fields.

**Cernox®** thin-film RTDs offer high sensitivity and low magnetic field-induced errors over the 2 K to 420 K temperature range. Cernox sensors require calibration.

**Platinum RTDs** offer high uniform sensitivity from 30 K to over 800 K. With excellent reproducibility, they are useful as thermometry standards. They follow a standard curve above 70 K and are interchangeable in many applications.



Typical sensor performance—see Appendix F for sample calculations of typical sensor performance

	Example Lake Shore sensor	Temperature	Nominal resistance/voltage	Typical sensor sensitivity <sup>7</sup>	Measurement resolution: temperature equivalents	Electronic accuracy: temperature equivalents	Temperature accuracy including electronic accuracy, CalCurve™, and calibrated sensor	Electronic control stability <sup>8</sup> : temperature equivalents
<b>Silicon diode</b>	DT-670-SD-13 with 1.4H calibration	1.4 K	1.664 V	-12.49 mV/K	0.8 mK	±13 mK	±25 mK	±1.6 mK
		77 K	1.028 V	-1.73 mV/K	5.8 mK	±76 mK	±98 mK	±11.6 mK
		300 K	0.5596 V	-2.3 mV/K	4.3 mK	±47 mK	±79 mK	±8.7 mK
		500 K	0.0907 V	-2.12 mV/K	4.8 mK	±40 mK	±90 mK	±9.6 mK
<b>Silicon diode</b>	DT-470-SD-13 with 1.4H calibration	1.4 K	1.6981 V	-13.1 mV/K	0.8 mK	±13 mK	±25 mK	±1.6 mK
		77 K	1.0203 V	-1.92 mV/K	5.2 mK	±68 mK	±90 mK	±10.4 mK
		300 K	0.5189 V	-2.4 mV/K	4.2 mK	±44 mK	±76 mK	±8.4 mK
		475 K	0.0906 V	-2.22 mV/K	4.6 mK	±39 mK	±89 mK	±9.2 mK
<b>100 Ω platinum RTD 500 Ω full scale</b>	PT-103 with 1.4J calibration	30 K	3.660 Ω	0.191 Ω/K	10.5 mK	±23 mK	±33 mK	±21 mK
		77 K	20.38 Ω	0.423 Ω/K	4.8 mK	±15 mK	±27 mK	±9.6 mK
		300 K	110.35 Ω	0.387 Ω/K	5.2 mK	±39 mK	±62 mK	±10.4 mK
		500 K	185.668 Ω	0.378 Ω/K	5.3 mK	±60 mK	±106 mK	±10.6 mK
<b>Cernox®</b>	CX-1050-SD- HT <sup>9</sup> with 4M calibration	4.2 K	3507.2 Ω	-1120.8 Ω/K	36 μK	±1.4 mK	±6.4 mK	±72 μK
		77 K	205.67 Ω	-2.4116 Ω/K	16.6 mK	±76 mK	±92 mK	±33.2 mK
		300 K	59.467 Ω	-0.1727 Ω/K	232 mK	±717 mK	±757 mK	±464 mK
		420 K	45.030 Ω	-0.0829 Ω/K	483 mK	±1.42 K	±1.49 K	±966 mK
<b>Germanium</b>	GR-300-AA with 0.3D calibration	1.2 K	600 Ω	-987 Ω/K	51 μK	±345 μK	±4.5 mK	±101 μK
		1.4 K	449 Ω	-581 Ω/K	86 μK	±481 μK	±4.7 mK	±172 μK
		4.2 K	94 Ω	-27 Ω/K	1.9 mK	±5.19 mK	±10.2 mK	±3.8 mK
		100 K	2.72 Ω	-0.024 Ω/K	2.1 K	±4.25 K	±4.27 K	±4.20 K
<b>Germanium</b>	GR-1400-AA with 1.4D calibration	4 K	1873 Ω	-1008 Ω/K	50 μK	±842 μK	±5.0 mK	±99 μK
		4.2 K	1689 Ω	-862 Ω/K	58 μK	±900 μK	±5.1 mK	±116 μK
		10 K	253 Ω	-62 Ω/K	807 μK	±3.2 mK	±8.2 mK	±1.6 mK
		100 K	2.80 Ω	-0.021 Ω/K	2.4 K	±4.86 K	±4.884 K	±4.81 K
<b>Thermocouple 50 mV</b>	Type K	75 K	-5862.9 μV	15.6 μV/K	26 mK	±0.25 K <sup>10</sup>	Calibration not available from Lake Shore	±52 mK
		300 K	1075.3 μV	40.6 μV/K	10 mK	±0.038 K <sup>10</sup>		±20 mK
		600 K	13325 μV	41.7 μV/K	10 mK	±0.184 K <sup>10</sup>		±20 mK
		1505 K	49998.3 μV	36.006 μV/K	12 mK	±0.73 K <sup>10</sup>		±24 mK

<sup>7</sup> Typical sensor sensitivities were taken from representative calibrations for the sensor listed

<sup>8</sup> Control stability of the electronics only, in an ideal thermal system

<sup>9</sup> Non-HT version maximum temperature: 325 K

<sup>10</sup> Accuracy specification does not include errors from room temperature compensation



## Model 325 Specifications

### Input specifications

	Sensor temperature coefficient	Input range	Excitation current	Display resolution	Measurement resolution	Electronic accuracy	Electronic control stability <sup>11</sup>
<b>Diode</b>	negative	0 V to 2.5 V	10 $\mu$ A $\pm$ 0.05% <sup>12,13</sup>	100 $\mu$ V	10 $\mu$ V	$\pm$ 80 $\mu$ V $\pm$ 0.005% of rdg	$\pm$ 20 $\mu$ V
	negative	0 V to 7.5 V	10 $\mu$ A $\pm$ 0.05% <sup>12,13</sup>	100 $\mu$ V	20 $\mu$ V	$\pm$ 320 $\mu$ V $\pm$ 0.01% of rdg	$\pm$ 40 $\mu$ V
<b>PTC RTD</b>	positive	0 $\Omega$ to 500 $\Omega$	1 mA <sup>14</sup>	10 m $\Omega$	2 m $\Omega$	$\pm$ 0.004 $\Omega$ $\pm$ 0.01% of rdg	$\pm$ 4 m $\Omega$
	positive	0 $\Omega$ to 5000 $\Omega$	1 mA <sup>14</sup>	100 m $\Omega$	20 m $\Omega$	$\pm$ 0.04 $\Omega$ $\pm$ 0.02% of rdg	$\pm$ 40 m $\Omega$
<b>NTC RTD</b>	negative	0 $\Omega$ to 7500 $\Omega$	10 $\mu$ A $\pm$ 0.05% <sup>14</sup>	100 m $\Omega$	40 m $\Omega$	$\pm$ 0.1 $\Omega$ $\pm$ 0.04% of rdg	$\pm$ 80 m $\Omega$
<b>Thermocouple</b>	positive	$\pm$ 25 mV	NA	1 $\mu$ V	0.4 $\mu$ V	$\pm$ 1 $\mu$ V $\pm$ 0.05% of rdg <sup>15</sup>	$\pm$ 0.8 $\mu$ V
	positive	$\pm$ 50 mV	NA	1 $\mu$ V	0.4 $\mu$ V	$\pm$ 1 $\mu$ V $\pm$ 0.05% of rdg <sup>15</sup>	$\pm$ 0.8 $\mu$ V

<sup>11</sup> Control stability of the electronics only, in an ideal thermal system

<sup>12</sup> Current source error has negligible effect on measurement accuracy

<sup>13</sup> Diode input excitation current can be set to 1 mA — refer to the Model 325 user manual for details

<sup>14</sup> Current source error is removed during calibration

<sup>15</sup> Accuracy specification does not include errors from room temperature compensation

### Thermometry

#### Number of inputs 2

**Input configuration** Each input is factory configured for either diode/RTD or thermocouple

**Isolation** Sensor inputs optically isolated from other circuits but not each other

**A/D resolution** 24-bit

**Input accuracy** Sensor dependent—refer to Input Specifications table

**Measurement resolution** Sensor dependent—refer to Input Specifications table

**Maximum update rate** 10 rdg/s on each input (except 5 rdg/s on input A when configured as thermocouple)

**User curves** Room for 15 200-point CalCurves™ or user curves

**SoftCal™** Improves accuracy of DT-470 diode to  $\pm$ 0.25 K

from 30 K to 375 K; improves accuracy of platinum RTDs to  $\pm$ 0.25 K from 70 K to 325 K; stored as user curves

**Filter** Averages 2 to 64 input readings

### Control

**Control loops** 2

**Control type** Closed loop digital PID with manual heater output or open loop

**Tuning** Autotune (one loop at a time), PID, PID zones

**Control stability** Sensor dependent—see Input Specification table

**PID control settings**

**Proportional (gain)** 0 to 1000 with 0.1 setting resolution

**Integral (reset)** 1 to 1000 (1000/s) with 0.1 setting resolution

**Derivative (rate)** 1 to 200% with 1% resolution

**Manual output** 0 to 100% with 0.01% setting resolution

**Zone control** 10 temperature zones with P, I, D, manual heater out, and heater range

**Setpoint ramping** 0.1 K/min to 100 K/min

**Safety limits** Curve temperature, power up heater off, short circuit protection

### Sensor input configuration

	Diode/RTD	Thermocouple
<b>Measurement type</b>	4-lead differential	2-lead differential, room temperature compensated
<b>Excitation</b>	Constant current with current reversal for RTDs	N/A
<b>Supported sensors</b>	Diodes: Silicon, GaAlAs RTDs: 100 $\Omega$ Platinum, 1000 $\Omega$ Platinum, Germanium, Carbon-Glass, Cernox®, and Rox™	Most thermocouple types
<b>Standard curves</b>	DT-470, DT-500D, DT-670, PT-100, PT-1000, RX-102A, RX-202A	Type E, Type K, Type T, AuFe 0.07% vs Cr, AuFe 0.03% vs Cr
<b>Input connector</b>	6-pin DIN	Ceramic isothermal block







### Loop 1 heater output

	25 $\Omega$ setting	50 $\Omega$ setting
Type	Variable DC current source	
D/A resolution	16-bit	
Max power	25 W	
Max current	1 A	0.71 A
Voltage compliance	25 V	35.4 V
Heater load range	20 $\Omega$ to 25 $\Omega$	40 $\Omega$ to 50 $\Omega$
Heater load for max power	25 $\Omega$	50 $\Omega$
Ranges	2 (2.5 W/25 W)	
Heater noise (<1 kHz)	1 $\mu$ A + 0.01% of output	
Grounding	Output referenced to chassis ground	
Heater connector	Dual banana	

### Loop 2 heater output

	25 $\Omega$ setting	50 $\Omega$ setting
Type	Variable DC voltage source	
D/A resolution	16-bit	
Max power	1 W	2 W
Max voltage	5 V	10 V
Current compliance	0.2 A	
Heater load range	$\geq$ 25 $\Omega$	$\geq$ 50 $\Omega$
Heater load for max power	25 $\Omega$	50 $\Omega$
Ranges	1	
Heater noise (<1 kHz)	50 $\mu$ V + 0.01% of output	
Grounding	Output referenced to chassis ground	
Heater connector	Detachable terminal block	

### Front panel

**Display** 2-line  $\times$  20-character, liquid crystal display with 5.5 mm character height

**Number of reading displays** 1 to 4

**Display units** K,  $^{\circ}$ C, V, mV,  $\Omega$

**Reading source** Temperature, sensor units

**Display update rate** 2 rdg/s

**Temp display resolution** 0.001 $^{\circ}$  from 0 $^{\circ}$  to 99.999 $^{\circ}$ , 0.01 $^{\circ}$  from 100 $^{\circ}$  to 999.99 $^{\circ}$ , 0.1 $^{\circ}$  above 1000 $^{\circ}$

**Sensor units display resolution** Sensor dependent; to 5 digits

**Other displays** Setpoint, Heater Range, and Heater Output (user selected)

**Setpoint setting resolution** Same as display resolution (actual resolution is sensor dependent)

**Heater output display** Numeric display in percent of full scale for power or current

**Heater output resolution** 1%

**Display annunciators** Control Input, Remote, Autotune

**Keypad** 20-key membrane, numeric and specific functions

**Front panel features** Front panel curve entry, keypad lock-out

### Interface

#### IEEE-488 interface

**Features** SH1, AH1, T5, L4, SR1, RL1, PPO, DC1, DTO, C0, E1

**Reading rate** To 10 rdg/s on each input

**Software support** LabVIEW™ driver (see [www.lakeshore.com](http://www.lakeshore.com))

#### Serial interface

**Electrical format** RS-232C

**Baud rates** 9600, 19200, 38400, 57600

**Connector** 9-pin D-style, DTE configuration

**Reading rate** To 10 rdg/s on each input

### General

**Ambient temperature** 15  $^{\circ}$ C to 35  $^{\circ}$ C at rated accuracy, 5  $^{\circ}$ C to 40  $^{\circ}$ C at reduced accuracy

**Power requirement** 100, 120, 220, 240 VAC, +6%, -10%, 50 or 60 Hz, 85 VA

**Size** 216 mm W  $\times$  89 mm H  $\times$  368 mm D (8.5 in  $\times$  3.5 in  $\times$  14.5 in), half rack

**Weight** 4.00 kg (8.82 lb)

**Approval** CE mark, RoHS

### Ordering information

#### Part number Description

<b>325</b>	2 diode/resistor inputs temperature controller, includes one dual banana jack heater output connector (106-009), two 6-pin DIN plug sensor input mating connectors (G-106-233), one 2-pin terminal block (106-735), a calibration certificate and a user's manual
<b>325-T1</b>	Model 325 with one diode/RTD and one thermocouple input
<b>325-T2</b>	Model 325 with two thermocouple inputs

#### Please indicate your power/cord configuration:

- 100 V—U.S. cord (NEMA 5-15)
- 120 V—U.S. cord (NEMA 5-15)
- 220 V—Euro cord (CEE 7/7)
- 240 V—Euro cord (CEE 7/7)
- 240 V—U.K. cord (BS 1363)
- 240 V—Swiss cord (SEV 1011)
- 220 V—China cord (GB 1002)

#### Accessories

<b>112-177</b>	Temperature controller cable, 3 m (10 ft)—IN STOCK
<b>112-178</b>	Temperature controller cable, 6 m (20 ft)
<b>112-180</b>	Temperature controller cable, 10 m (33 ft)
<b>6201</b>	1 m (3.3 ft long) IEEE-488 (GPIB) computer interface cable assembly
<b>RM-1/2</b>	Kit for mounting one 1/2 rack temperature controller in a 482.6 mm (19 in) rack, 90 mm (3.5 in) high
<b>RM-2</b>	Kit for mounting two 1/2 rack temperature controllers in a 482.6 mm (19 in) rack, 135 mm (5.25 in) high
<b>G-106-735</b>	Terminal block, 2-pin
<b>G-106-233</b>	Sensor input mating connector (6-pin DIN plug)
<b>106-009</b>	Banana plug, dual
<b>CAL-325-CERT</b>	Instrument calibration with certificate
<b>CAL-325-DATA</b>	Instrument recalibration with certificate and data
<b>119-041</b>	Model 325 temperature controller manual

All specifications are subject to change without notice





## 240 Series Temperature Sensor Input Modules

240 Series modules are the ideal companion to Cernox®



### 240-2P features

For smaller installations and high-speed measurements

- Updates readings as fast as 1 ms
- Dedicated readings on front screen
- Highest level of equipment redundancy

### 240-8P features

For installations with many sensors

- Most cost-effective solution in large installations
- More sensors for each fieldbus address





## Simplifying large-scale cryogenic temperature measurement

Lake Shore benchtop cryogenic instruments are trusted throughout the world for precision temperature measurement—and now that same measurement performance can be achieved in widely distributed high-energy physics applications like particle accelerators, fusion reactors, and other large industrial sites.



Integrates seamlessly with industry-leading Lake Shore Cernox® RTDs, platinum RTDs, and silicon diodes, providing a flexible platform for reporting temperature measurements over a PLC network

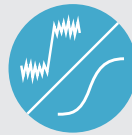

*Normal mode* with EMF-cancellation and signal filtering for the best measurement possible, or *high-speed mode* for the fastest notification of a temperature change



PROFIBUS certified, allowing this module to be integrated into a wide range of PLC networks



A high-quality OLED display on the front of the unit provides helpful status and measurement data; this is in addition to being able to access this information via the PLC network or the local USB connection

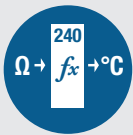

Temperature values are communicated directly with the PLC master device, removing the need for additional analog conversion equipment or complex PLC programming to generate temperature values



Convenient pluggable connectors enable individual sensors to be disconnected for maintenance without losing readings from other sensors on the same module



Measurement circuitry based on Lake Shore's industry-leading benchtop instruments, allowing for longer cable runs between sensor and module; ideal for applications where sensors must be located in hazardous environments



Easy DIN rail mounting with integrated rear connections allowing power and fieldbus communications to be shared between modules

### Native fieldbus integration

The 240 Series modules connect with PROFIBUS-DP compatible networks, giving PLCs direct access to temperature values. This eliminates the need for additional I/O modules and complex conversion algorithms within the PLC to generate values when working with cryogenic temperature sensors.

The ability to communicate temperature directly with a PLC has many advantages:

- Commercially supported solution with proven results
- No additional I/O modules required to energize or read the temperature sensor
- The process of converting from measured voltage or resistance to temperature units does not need to be programmed into the PLC's control logic.

Internally converting to temperature units represents the greatest reduction in time, cost, and risk when building a control system that includes cryogenic temperature management. Creating code that generates temperature values reliably can take days and the ability to maintain that code then becomes a liability if the attached sensor ever needs to be changed. Lake Shore 240 Series modules are the only low-risk option available for cryogenic temperature control in a PLC network. Direct instrument connection via USB makes configuration and maintenance easy and can be used for permanent temperature monitoring in systems not compatible with PROFIBUS-DP.



## Intuitive module configuration

The Lake Shore MeasureLINK™ software allows a streamlined configuration experience for all 240 Series input modules. Connecting directly to the module through the USB port provides immediate access for MeasureLINK and allows complete configuration of the module in just a few minutes.

MeasureLINK™ provides access to:

- Module configuration (communications settings and module maintenance)
- Input configuration (sensor calibration curve loading and other measurement settings)
- Live measurement readings for all module inputs simultaneously

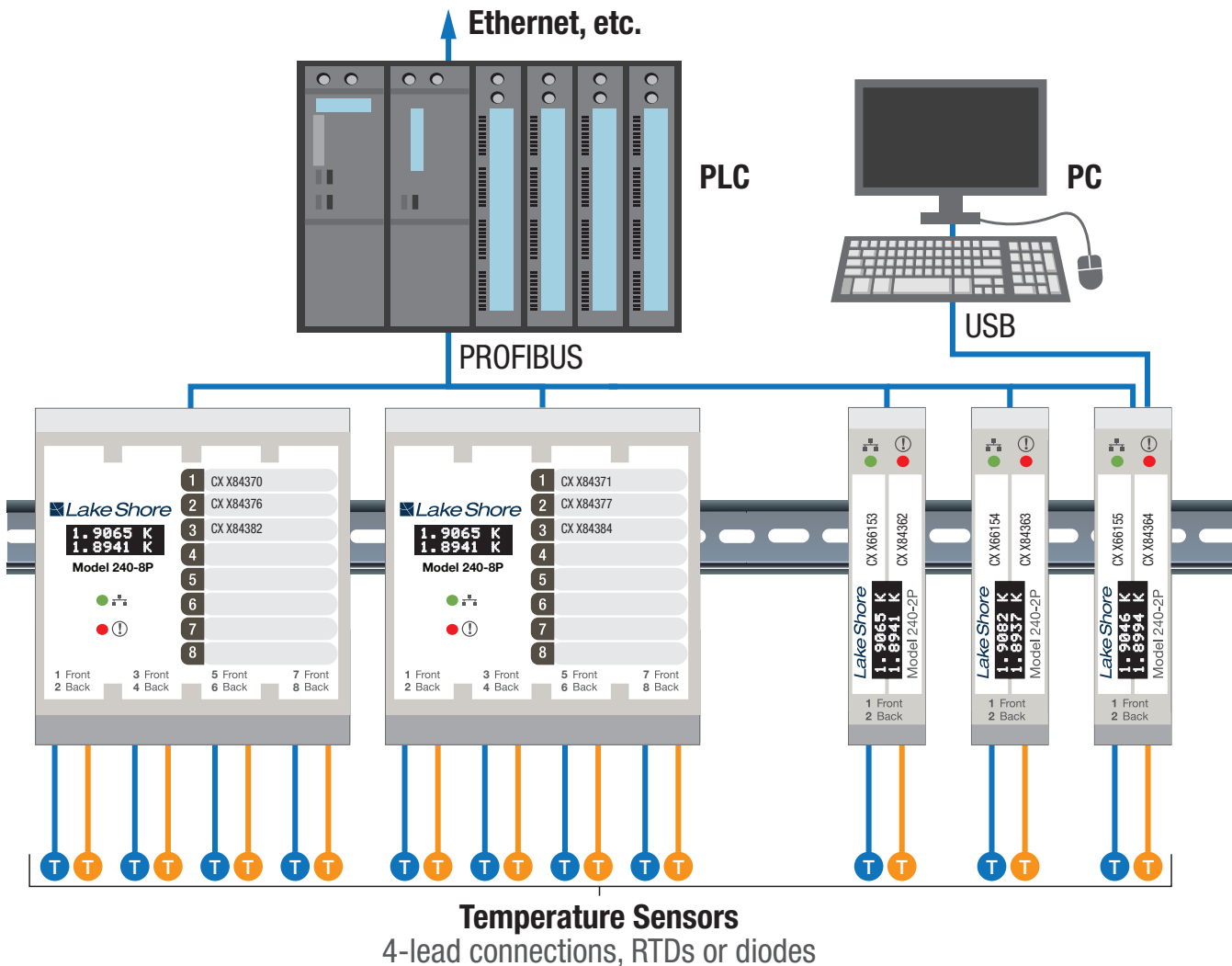
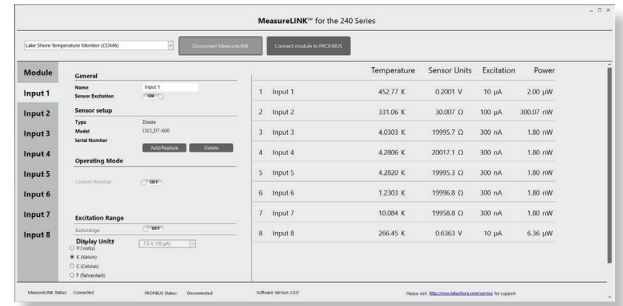



### Convenient OLED display

The built-in OLED display in every 240 Series input module allows immediate verification that a module is operating correctly by displaying temperature conversion values or error states if something is not operating as intended.



### User-friendly sensor wiring

Pluggable terminal blocks provide an easy way to pre-terminate sensor wire to the included connectors before plugging them into the input module. Sensor maintenance or replacement is also made easier using these connectors, particularly if the remaining sensors on the module must remain live while another sensor is replaced.

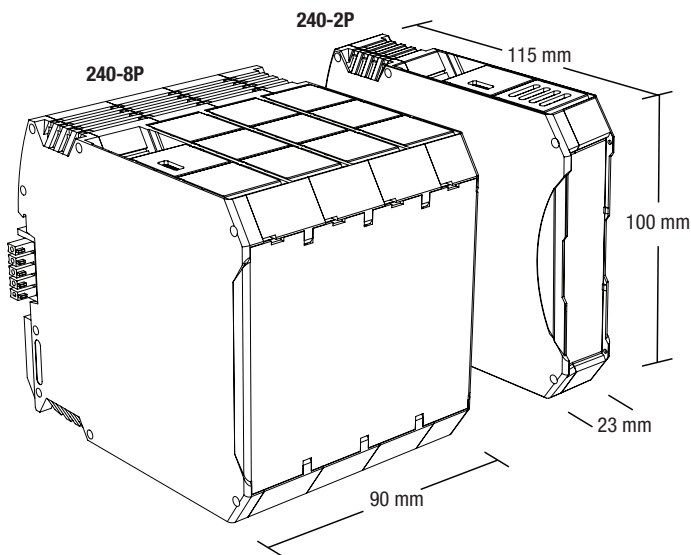
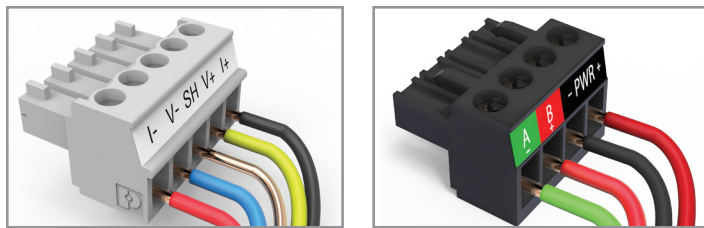

### Built-in temperature conversion

The process of converting from sensor units (ohms for RTDs and volts for diodes) to temperature values is extremely important and can be quite challenging. Many of the best cryogenic sensors (such as Cernox®) have unique calibration curves that change from device to device. Even sensors with common curves can become more accurate through the process of creating a unique calibration curve for those sensors.

Lake Shore's 240 Series modules take the time and risk out of performing these conversions, in a way that guarantees sensor calibration accuracy is not degraded. The product software features native support for the electronic calibration files provided with each Lake Shore calibrated temperature sensor and includes many of the standard temperature conversion curves for other common interchangeable sensors.

This allows 240 Series modules to communicate temperature values automatically after just a few minutes of initial setup.

### 240 Series temperature conversion flowchart

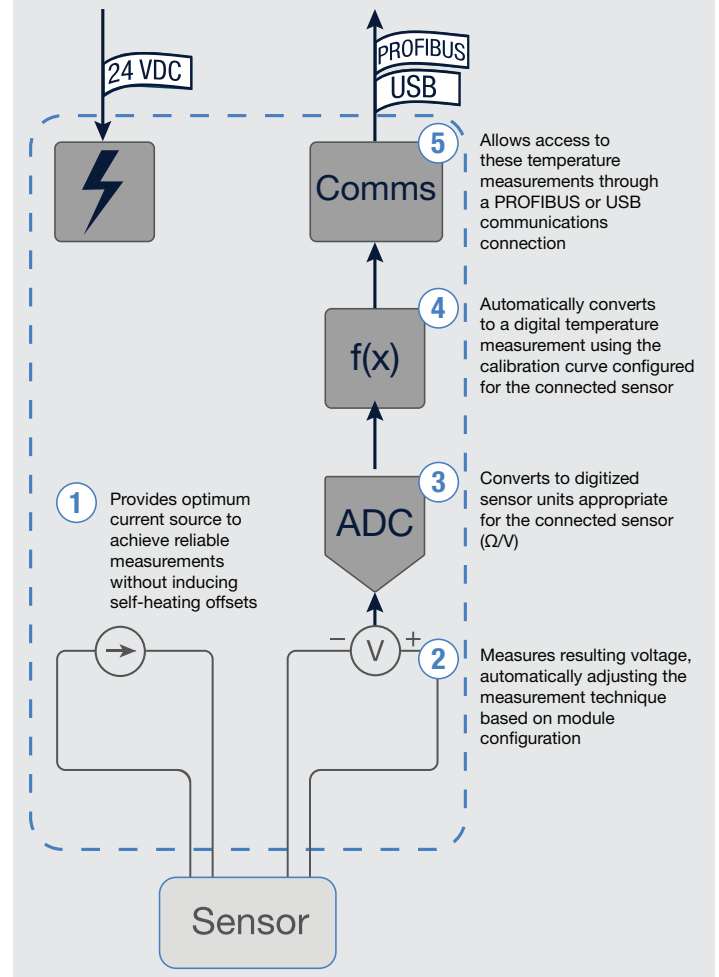



## Extended sensor wire lengths

An unfortunate characteristic of many high-energy physics facilities is the level of radiation generated by the machine during operation. Lake Shore Cernox® sensors are designed to tolerate this radiation, however, electronic devices require protection from this radiation. Lake Shore's 240 Series modules facilitate this requirement by allowing extremely long sensor cabling to be employed between the sensor and input module. See the application note at [www.lakeshore.com](http://www.lakeshore.com) for additional information on this topic.

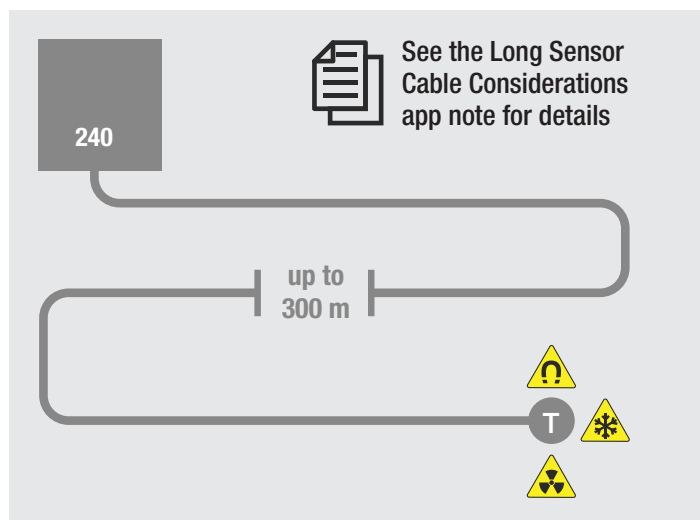
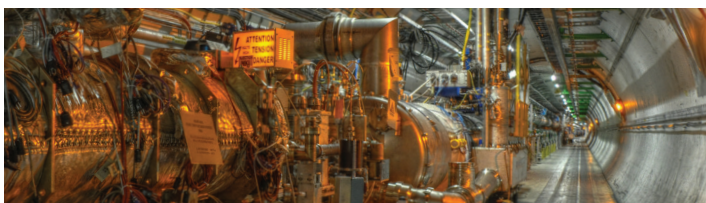

## Simplifying cryogenic sensor excitation

Cryogenic temperature monitoring requires a constant balance between supplying enough power to make good measurements and keeping the power low enough to minimize sensor self-heating errors. Lake Shore's 240 Series optimize measurement accuracy and resolution by automatically adjusting excitation level based on the temperature and connected sensor.

Thermal EMF offsets are also eliminated using current reversal techniques, canceling out these unwanted measurement errors that would be present in any other equipment not specifically designed for cryogenic measurements.

### Normal mode

Best option for most installations. Provides the most accurate and precise measurements and is available on all 240 Series models.

- Current reversal available to remove thermal EMF offsets
- Modified measurement window to ignore signal rise when using long cable runs
- Fixed 100 ms update rate for the Model 240-2P or 400 ms for the Model 240-8P

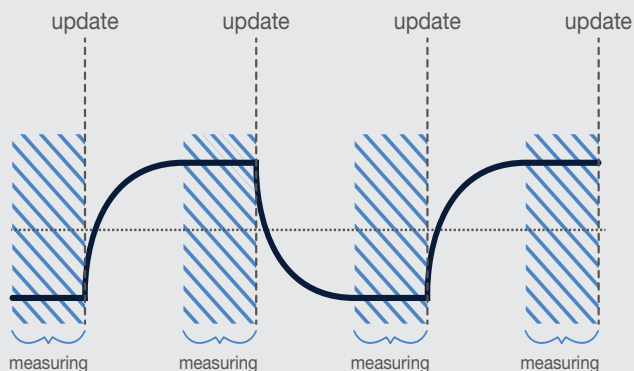

### High-speed mode (240-2P only)

Measurement option for times when low latency measurements are required. This feature is best used with sensors with extremely fast thermal response times.

- Update rates from 1 to 100 ms; configurable to match the network update rate
- Constant measurement with no interruptions caused by current reversal of input switching
- Current reversal not available in this mode, so thermal EMF offsets should be anticipated and managed

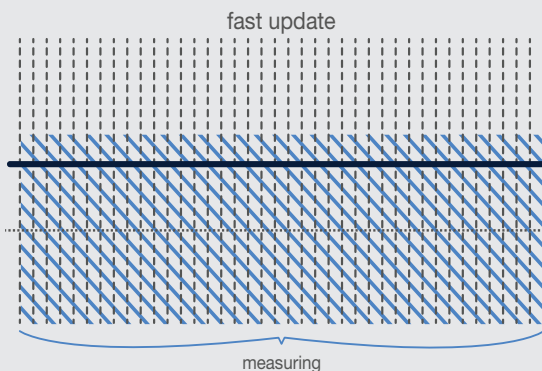



## Specifications

### Input specifications

Standard inputs (normal mode, reversing<sup>1</sup>)

	Sensor temperature coefficient	Input range	Excitation current	Display resolution	Measurement resolution	Electronic accuracy (at 25 °C)	Measurement temperature coefficient
Diode	Negative	0 V to 7.5 V	10 µA ±0.05%	100 µV	20 µV	±320 µV ±0.01% of rdg	(20 µV + 0.0015% of rdg)/°C <sup>1</sup>
PTC RTD 1 mA	Positive	0 Ω to 1 kΩ	1 mA	10 mΩ	20 mΩ	±0.04 Ω ±0.02% of rdg	(1 mΩ + 0.0015% of rdg)/°C <sup>1</sup>
NTC RTD 10 mV	Negative	0 Ω to 10 Ω	1 mA	0.1 mΩ	0.1 mΩ + 0.002% of rdg	±0.002 Ω ±0.06% of rdg	(0.1 mΩ + 0.0015% of rdg)/°C <sup>1</sup>
		0 Ω to 30 Ω	300 µA	0.1 mΩ	0.3 mΩ + 0.002% of rdg	±0.002 Ω ±0.06% of rdg	(0.1 mΩ + 0.0015% of rdg)/°C <sup>1</sup>
		0 Ω to 100 Ω	100 µA	1 mΩ	1 mΩ + 0.002% of rdg	±0.01 Ω ±0.04% of rdg	(0.1 mΩ + 0.0015% of rdg)/°C <sup>1</sup>
		0 Ω to 300 Ω	30 µA	1 mΩ	3 mΩ + 0.002% of rdg	±0.01 Ω ±0.04% of rdg	(0.3 mΩ + 0.0015% of rdg)/°C <sup>1</sup>
		0 Ω to 1 kΩ	10 µA	10 mΩ	10 mΩ + 0.002% of rdg	±0.01 Ω ±0.04% of rdg	(1 mΩ + 0.0015% of rdg)/°C <sup>1</sup>
		0 Ω to 3 kΩ	3 µA	10 mΩ	30 mΩ + 0.002% of rdg	±0.01 Ω ±0.04% of rdg	(3 mΩ + 0.0015% of rdg)/°C <sup>1</sup>
		0 Ω to 10 kΩ	1 µA	100 mΩ	100 mΩ + 0.002% of rdg	±1.0 Ω ±0.04% of rdg	(10 mΩ + 0.0015% of rdg)/°C <sup>1</sup>
		0 Ω to 30 kΩ	300 nA	100 mΩ	300 mΩ + 0.002% of rdg	±2.0 Ω ±0.04% of rdg	(30 mΩ + 0.0015% of rdg)/°C <sup>1</sup>
		0 Ω to 100 kΩ	100 nA	1 Ω	1 Ω + 0.002% of rdg	±10.0 Ω ±0.04% of rdg	(100 mΩ + 0.0015% of rdg)/°C <sup>1</sup>

<sup>1</sup> Current reversal used only for resistive ranges

<sup>2</sup> Rated temperature coefficient from 15 °C to 35 °C, reduced accuracy from -20 °C to 50 °C

### Sensor input configuration

	RTD	Diode
Measurement type	4-lead differential	4-lead differential
Excitation	Constant current with current reversal	10 µA constant current
Supported sensors	Cernox®, platinum, germanium, carbon-glass, rhodium-iron, and Rox™	Silicon, GaAlAs
Standard curves supplied	LSCI PT-100, IEC PT-100, IEC PT-1000	LSCI DT-670, LSCI DT-470
Input connector	5-pin terminal plug	5-pin terminal plug

### Thermometry

Number of inputs: 2 (Model 240-2P), 8 (Model 240-8P)

Isolation: Sensor inputs isolated from other circuits but not each other

Input accuracy: Sensor dependent, refer to Input Specifications table

Measurement resolution: Sensor dependent, refer to Input Specifications table

### Measurement speed

	240-2P	240-8P
<b>Normal mode</b>		
Update rate	10 rdg/s <sup>1</sup>	2.5 rdg/s <sup>1,2</sup>
Filter	100 ms	100 ms
<b>High speed mode</b>		
Update rate	10 to 1000 rdg/s	N/A
Filter	1 to 100 ms <sup>3</sup>	N/A

<sup>1</sup> Update rate is halved when input is on the 100 kΩ range with current reversal enabled

<sup>2</sup> All inputs enabled

<sup>3</sup> Filter settings are tied to the update rate (filter = 1000/update rate)

Temperature conversion: Lake Shore calibration curves (linear interpolation)

User curves: Each input has storage for one 200-point curve

Reporting units: K, °C, °F, V, Ω

### Digital I/O – PROFIBUS

Protocol: DP-V0

Baud rates: 9.6 k, 19.2 k, 45.45 k, 93.75 k, 187.5 k, 500 k, 1.5 M, 3 M, 6 M, 12 M (auto baud-rate detect)

Identification number: 0x0F84

Reading data format: Single precision float (32-bit)

Reading rate: Matches update rate of the instrument

### Digital I/O – USB

Function: Emulates a standard RS-232 serial port

Baud rate: 115,200, 8 data bits, 1 stop bit, no parity, no handshaking

Connector: USB micro-B

Reading rate: Matches update rate of the instrument

### Management

Module configuration: Module configured over USB interface

Configuration software: MeasureLINK™ (free download, supported on Windows 7, 8, and 10)

Firmware update: Firmware updated over USB port

### Display

Display: 128 × 32 pixel OLED

Display units: K, °C, °F, V, Ω

Display update rate: 2 rdg/s

	240-2P	240-8P
Displayed readings	2	2
Readings cycling	Fixed (no cycling)	3 second hold per pair

Temperature display resolution: 0.0001° from 0° to 9.9999°, 0.001° from 10° to 99.999°,

0.01° from 100° to 999.99°, 0.1° above 1000°

Sensor units display resolution: Sensor dependent, to 5 digits

LED annunciators: Module status and communication status



#### Power supply

Connection: Screw terminal

Voltage requirement: 24 VDC,  $\pm 10\%$

Current requirement: 100 mA per connected module

Power distribution: Maximum 20 units connected through the DIN rail backplane connector (power supply must be able to source required current)

Internal protection: Over-voltage, under-voltage, and reverse polarity protection

#### Physical

Case material: Polyamide

Mounting: 35 mm DIN rail (EN 50022)

Water ingress: IP20: not protected against harmful ingress of water

Case inflammability: Class V0 according to UL 94

Sensor connector wire size: 16 to 28 AWG

Power connector wire size: 12 to 24 AWG

Size: 22.5 mm W  $\times$  115 mm H  $\times$  100 mm L (240-2P)

90 mm W  $\times$  115 mm H  $\times$  100 mm L (240-8P)

Weight: 120 g (240-2P), 300 g (240-8P)

#### Environmental

Compliance: RoHS; CE

Operating temperature: 15 °C to 35 °C at rated accuracy, -20 °C to 50 °C at reduced accuracy

Storage temperature: -40 °C to 85 °C

Relative humidity: 0 to 70% at rated accuracy, reduced accuracy up to 95%, non-condensing

## Ordering information

Part number	Description
240-2P	2-input cryogenic temperature sensor input module
240-8P	8-input cryogenic temperature sensor input module

#### Accessories/options

240-ACC-KIT	240 Series accessory kit. Contains items needed for configuration of one or more 240 modules. Includes: 240 Series manual, 240 Series quick start guide, USB cable, flash drive containing product data and software, 240 Series screwdriver, 2 spare power, 4 spare sensor, and 2 spare backplane connectors.
-------------	--

All specifications are subject to change without notice



## Getting to know the 240 Series

A convenient self-contained kit provides most of the components required to evaluate these modules in your systems. Everything you need to connect a set of 240 Series input modules to your PLC system and start taking readings, without the requirement to have a functioning cryogenic system to take readings from. The evaluation kit contains:

- A 240-2P and 240-8P input module
- Universal power supply
- DIN rail
- Dummy sensors
- Software and documentation
- Other miscellaneous accessories

Available to keep or to demo on a short term basis. Contact your Lake Shore representative to secure your evaluation kit today.







# Model 224 Temperature Monitor



## Model 224 features

- Lake Shore's most capable cryogenic temperature monitor
- Equipped with 12 sensor channels for maximum monitoring capabilities
- Precisely measures in both higher temperature and cryogenic applications—down to 300 mK
- Ideal for multi-sensor lab uses, particularly for monitoring Cernox® sensors
- Ethernet, USB and IEEE-488 computer interfaces
- Proven, intuitive user interface
- Customizable display enables you to label individual input channels
- CE certification
- Full 3 year standard warranty





## Introduction

The Lake Shore Model 224 temperature monitor offers precision measurement in a wide range of cryogenic and higher-temperature applications with the ability to easily monitor up to 12 sensor channels. It provides better measurement performance in applications where researchers need to ensure accuracy and precision in their low cryogenic temperature monitoring. Used with Lake Shore's Cernox® sensors, the Model 224 enables reliable and repeatable temperature measurement over a broad range and as low as 300 mK.

Cernox thin-film RTD sensors offer high sensitivity and low magnetic field-induced errors at cryogenic temperatures. The Model 224 has been optimized for use with these well-respected temperature sensors, and features many of the same advanced capabilities of Lake Shore Model 336 temperature controller, including its proven high-precision input circuitry.

In addition to Cernox, the Model 224 supports other NTC RTDs, PTC RTDs such as platinum sensors, and diodes such as the Lake Shore DT-670 Series. In cryogenic applications, the monitor is an ideal addition to any university or commercial low-temperature research lab requiring measurement flexibility using multiple sensors and sensor types. Used with silicon diodes, it provides accurate measurements in cryo-cooler and cryo-gas production applications from 1.4 K to above room temperature. Connected to PTC RTDs (platinum and rhodium-iron sensors), the Model 224 works well in cryogenic applications at liquid nitrogen temperatures.

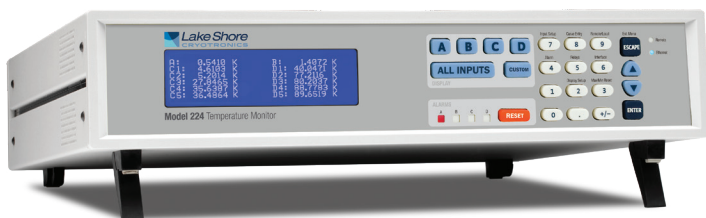

You can set up different sensor types and responses on each input to support simultaneous measurement of various critical points in a system. Examples include monitoring multiple cryogenic refrigeration systems (e.g., liquid nitrogen Dewars, He-4 cryostats, and closed-cycle refrigerators), multiple stages within systems operating at different temperature levels, thermal gradient profiling, redundant measurements of critical values, leak detection, and other cryogenic applications where you need accurate readings at multiple points. Alarm thresholds can be configured independently for each input, and alarm events can activate the unit's relay outputs for hard-wired triggering of other systems or audible annunciators. Relays can be activated on high, low, or both alarms for any input.

## Configure each input independently

Because the Model 224 features 12 independently configurable 6-pin DIN inputs, you can set it up for a different sensor on each input and run a number of different measurements simultaneously for various critical points in a system. Two inputs (A and B) are dedicated and non-scanned, updated at 10 rdg/s. The remaining 10 are scanned channels—inputs C and D can have up to five input devices each. These scanned channels are read anywhere from 1 to 10 rdg/s, depending on how many are being used at once.



Press any of the 4 input buttons (A, B, C or D) to view or change the parameters for each channel in the input display mode

The Model 224 features four high-resolution, 24-bit analog-to-digital converters for fast measurements. Optical isolation of input circuitry reduces line noise—interference that can skew low-level measurements—while providing repeatable sensor measurements.

Current reversal eliminates thermal electromotive force (EMF) errors when using resistance sensors. Also, nine excitation currents enable temperature measurements down to 300 mK when you use the appropriate NTC RTDs. When autoranging is enabled, the range will be automatically selected so that the excitation voltage is below 10 mV. This keeps the power dissipated in the sensor at a minimum, yet still at enough of a level to provide accurate measurements.

## Monitor locally or remotely—from anywhere

For local monitoring, the front panel of the Model 224 features a bright liquid crystal display with an LED backlight that shows up to 12 readings simultaneously, or, you can even display a single sensor input to see greater detail at a glance.

Plus, monitoring can be done over a network. Using the Ethernet port on the Model 224, you can keep an eye on temperatures and log measurement data remotely via a networked local PC or even remotely over a TCP/IP Internet connection from anywhere. A chart recorder utility embedded in the Ethernet module enables real-time charting of temperatures using a convenient graphical interface. You can also interface with the temperature monitor or link it to a data acquisition system via its serial USB or parallel IEEE-488 ports.



**Intuitive, configurable display**

The Model 224 front panel features a 23-key keypad and intuitive user interface for easy navigation of the temperature monitor's functions.

For added convenience, you can also custom label each sensor input, eliminating the guesswork in remembering or determining the location to which a sensor input is associated.



Custom display modes can show multiple configurations of channels. The display above shows the 4 main inputs with their custom labels, while the one below shows all 12 channels plus 4 additional settings

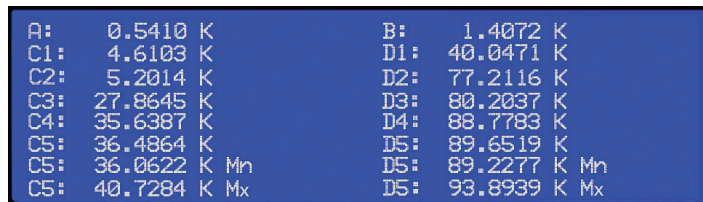

**Stores response curves**

Like the Lake Shore Model 336, the Model 224 includes standard temperature sensor calibration curves for silicon diodes, platinum RTDs, and Rox™ (ruthenium oxide) RTDs.

The monitor's non-volatile memory enables users to store up to 39 200-point CalCurves for Lake Shore calibrated sensors or user curves. Lake Shore also offers curve handler software, which allows you to upload and manipulate temperature sensor calibration data.

And for applications requiring more accuracy than what's available using the built-in sensor curves, the Model 224 includes the Lake Shore SoftCal™ algorithm. It generates curves for silicon diodes and platinum RTDs for storage as user curves.

**Sensor Selection**

**Sensor temperature range (sensors sold separately)**

		Model	Useful range	Magnetic field use	
<b>Negative temperature coefficient RTDs</b>	Cernox®	CX-1010	0.3 K to 325 K <sup>1</sup>	T > 2 K & B ≤ 19 T	
	Cernox®	CX-1030-HT	0.3 K to 420 K <sup>1,2</sup>	T > 2 K & B ≤ 19 T	
	Cernox®	CX-1050-HT	1.4 K to 420 K <sup>1</sup>	T > 2 K & B ≤ 19 T	
	Cernox®	CX-1070-HT	4 K to 420 K <sup>1</sup>	T > 2 K & B ≤ 19 T	
	Cernox®	CX-1080-HT	20 K to 420 K <sup>1</sup>	T > 2 K & B ≤ 19 T	
	Germanium	GR-300-AA	0.35 K to 100 K <sup>2</sup>	Not recommended	
	Germanium	GR-1400-AA	1.8 K to 100 K <sup>2</sup>	Not recommended	
	Rox™	RX-102	0.3 K to 40 K <sup>2</sup>	T > 2 K & B ≤ 10 T	
	Rox™	RX-103	1.4 K to 40 K	T > 2 K & B ≤ 10 T	
	Rox™	RX-202	0.3 K to 40 K <sup>2</sup>	T > 2 K & B ≤ 10 T	
<b>Diodes</b>	Silicon diode	DT-670-SD	1.4 K to 500 K	T ≥ 60 K & B ≤ 3 T	
	Silicon diode	DT-670E-BR	30 K to 500 K	T ≥ 60 K & B ≤ 3 T	
	Silicon diode	DT-414	1.4 K to 375 K	T ≥ 60 K & B ≤ 3 T	
	Silicon diode	DT-421	1.4 K to 325 K	T ≥ 60 K & B ≤ 3 T	
	Silicon diode	DT-470-SD	1.4 K to 500 K	T ≥ 60 K & B ≤ 3 T	
	Silicon diode	DT-471-SD	10 K to 500 K	T ≥ 60 K & B ≤ 3 T	
	GaAlAs diode	TG-120-P	1.4 K to 325 K	T > 4.2 K & B ≤ 5 T	
	GaAlAs diode	TG-120-PL	1.4 K to 325 K	T > 4.2 K & B ≤ 5 T	
	GaAlAs diode	TG-120-SD	1.4 K to 500 K	T > 4.2 K & B ≤ 5 T	
	<b>Positive temperature coefficient RTDs</b>	100 Ω platinum	PT-102/3	14 K to 873 K	T > 40 K & B ≤ 2.5 T
100 Ω platinum		PT-111	14 K to 673 K	T > 40 K & B ≤ 2.5 T	
Rhodium-iron		RF-800-4	1.4 K to 500 K	T > 77 K & B ≤ 8 T	
		Rhodium-iron	RF-100T/U	1.4 K to 325 K	T > 77 K & B ≤ 8 T

<sup>1</sup> Non-HT version maximum temperature: 325 K

<sup>2</sup> Low temperature specified with self-heating error: ≤5 mK

**Model 224 rear panel**

- 1 Sensor input connectors
- 2 Line input assembly
- 3 Terminal block
- 4 Ethernet interface
- 5 USB interface
- 6 IEEE-488 interface





## Ideal applications

- Labs with multiple temperature sensors
- Applications where both cryogenic and higher temperature readings are required
- Monitoring of simple Dewars and LN cryostats (>4.2 K)
- Closed-cycle refrigerators (CCRs) at 3 K to 4 K
- Pumped He-4 (1.4 K) and He-3 (300 mK) systems
- Temperature monitoring where superconducting magnets are used, such as in mass spectrometer and particle accelerator equipment

## See our high-performance, highly flexible Cernox® sensors

- Low magnetic field-induced errors
- A temperature range of 100 mK to 420 K (model dependent)
- High sensitivity at low temperatures and good sensitivity over a broad range
- Excellent resistance to ionizing radiation
- Bare die cryogenic temperature sensor with fast characteristic thermal response times: 1.5 ms at 4.2 K, 50 ms at 77 K
- Broad selection of models to meet your thermometry needs
- Excellent stability
- A variety of packaging options

These thin-film resistance cryogenic sensors offer significant advantages over diodes and conventional RTD sensors. The smaller package size makes them useful in a wide range of experimental mounting schemes, and they are also available in a chip form.





## Model 224 Specifications

### Input specifications

Sensor temperature coefficient	Input Range	Excitation current	Display resolution	Measurement resolution	Electronic accuracy (at 25 °C)	Measurement temperature coefficient	
<b>NTC RTD</b> 10 mV	0 Ω to 10 Ω	1 mA <sup>3</sup>	0.1 mΩ	0.15 mΩ	±0.002 Ω ±0.06% of rdg	(0.01 mΩ + 0.001% of rdg)/°C	
	0 Ω to 30 Ω	300 μA <sup>3</sup>	0.1 mΩ	0.45 mΩ	±0.002 Ω ±0.06% of rdg	(0.03 mΩ + 0.0015% of rdg)/°C	
	0 Ω to 100 Ω	100 μA <sup>3</sup>	1 mΩ	1.5 mΩ	±0.01 Ω ±0.04% of rdg	(0.1 mΩ + 0.001% of rdg)/°C	
	0 Ω to 300 Ω	30 μA <sup>3</sup>	1 mΩ	4.5 mΩ	±0.01 Ω ±0.04% of rdg	(0.3 mΩ + 0.0015% of rdg)/°C	
	Negative	0 Ω to 1 kΩ	10 μA <sup>3</sup>	10 mΩ	15 mΩ +0.002% of rdg	±0.1 Ω ±0.04% of rdg	(1 mΩ + 0.001% of rdg)/°C
		0 Ω to 3 kΩ	3 μA <sup>3</sup>	10 mΩ	45 mΩ +0.002% of rdg	±0.1 Ω ±0.04% of rdg	(3 mΩ + 0.0015% of rdg)/°C
		0 Ω to 10 kΩ	1 μA <sup>3</sup>	100 mΩ	150 mΩ +0.002% of rdg	±1.0 Ω ±0.04% of rdg	(10 mΩ + 0.001% of rdg)/°C
		0 Ω to 30 kΩ	300 nA <sup>3</sup>	100 mΩ	450 mΩ +0.002% of rdg	±2.0 Ω ±0.04% of rdg	(30 mΩ + 0.001% of rdg)/°C
		0 Ω to 100 kΩ	100 nA <sup>3</sup>	1 Ω	1.5 Ω +0.005% of rdg	±10.0 Ω ±0.04% of rdg	(100 mΩ + 0.002% of rdg)/°C
<b>Diode</b>	Negative	0 V to 2.5 V	10 μA ±0.05% <sup>4,5</sup>	10 μV	10 μV	±80 μV ±0.005% of rdg	(10 μV + 0.0005% of rdg)/°C
		0 V to 10 V	10 μA ±0.05% <sup>4,5</sup>	100 μV	20 μV	±320 μV ±0.01% of rdg	(20 μV + 0.0005% of rdg)/°C
<b>PTC RTD</b>	0 Ω to 10 Ω	1 mA <sup>3</sup>	0.1 mΩ	0.2 mΩ	±0.002 Ω ±0.01% of rdg	(0.01 mΩ + 0.001% of rdg)/°C	
	0 Ω to 30 Ω	1 mA <sup>3</sup>	0.1 mΩ	0.2 mΩ	±0.002 Ω ±0.01% of rdg	(0.03 mΩ + 0.001% of rdg)/°C	
	0 Ω to 100 Ω	1 mA <sup>3</sup>	1 mΩ	2 mΩ	±0.004 Ω ±0.01% of rdg	(0.1 mΩ + 0.001% of rdg)/°C	
	Positive	0 Ω to 300 Ω	1 mA <sup>3</sup>	1 mΩ	2 mΩ	±0.004 Ω ±0.01% of rdg	(0.3 mΩ + 0.001% of rdg)/°C
		0 Ω to 1 kΩ	1 mA <sup>3</sup>	10 mΩ	20 mΩ	±0.04 Ω ±0.02% of rdg	(1 mΩ + 0.001% of rdg)/°C
		0 Ω to 3 kΩ	1 mA <sup>3</sup>	10 mΩ	20 mΩ	±0.04 Ω ±0.02% of rdg	(3 mΩ + 0.001% of rdg)/°C
		0 Ω to 10 kΩ	1 mA <sup>3</sup>	100 mΩ	200 mΩ	±0.4 Ω ±0.02% of rdg	(10 mΩ + 0.001% of rdg)/°C

<sup>3</sup> Current source error is removed during calibration

<sup>4</sup> Current source error has negligible effect on measurement accuracy

<sup>5</sup> Diode input excitation can be set to 1 mA

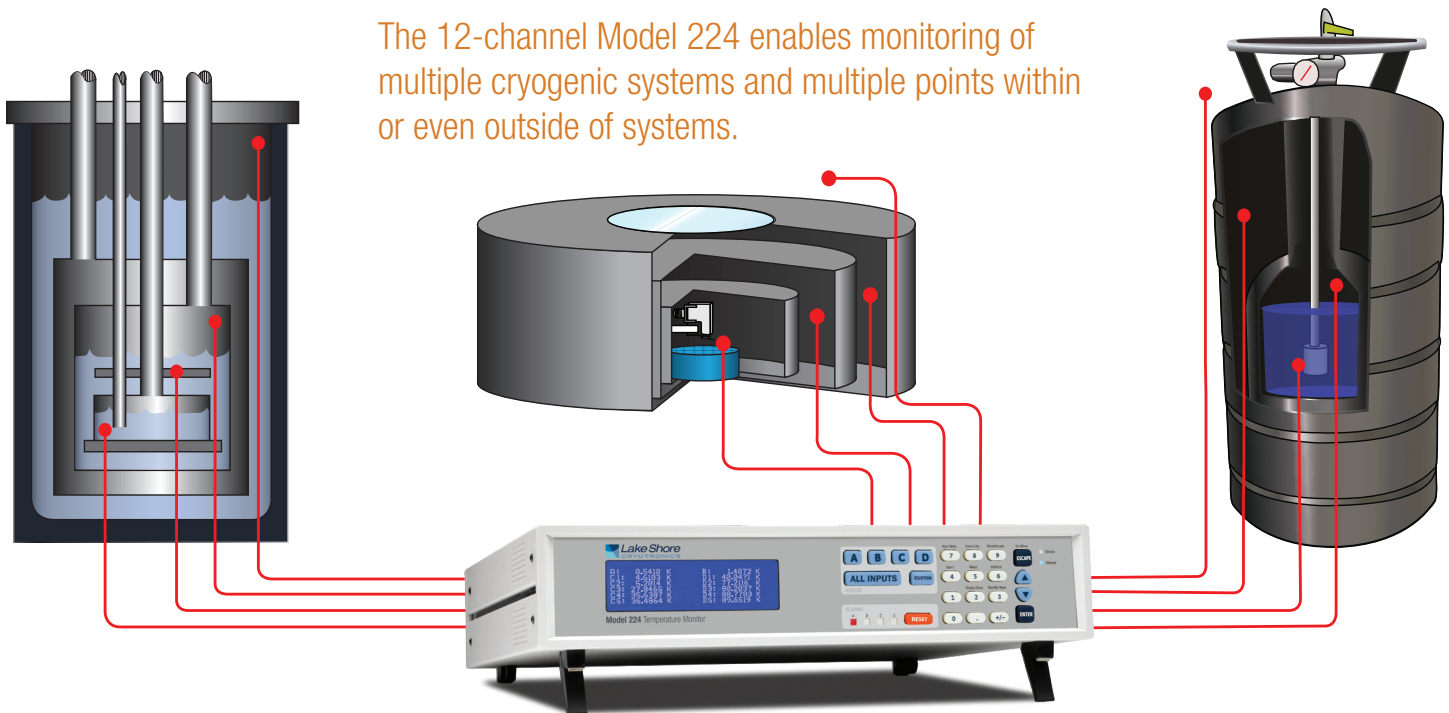

The 12-channel Model 224 enables monitoring of multiple cryogenic systems and multiple points within or even outside of systems.



## Sensor input configuration

	Diode/RTD
<b>Measurement type</b>	4-lead differential
<b>Excitation</b>	Constant current with current reversal for RTDs
<b>Supported sensors</b>	RTDs: Cernox <sup>®</sup> , 100 Ω platinum, 1000 Ω platinum, germanium, carbon-glass, and Rox <sup>™</sup> Diodes: silicon, GaAlAs
<b>Standard curves</b>	DT-470, DT-670, DT-500-D, DT-500-E1, PT-100, PT-1000, RX-102A, RX-202A
<b>Input connector</b>	6-pin DIN

## Thermometry

**Number of inputs** 12 (2 dedicated; 10 scanned)

**Input configuration** Inputs can be configured independently from the front panel to accept any of the supported input types

**Isolation** Sensor inputs optically isolated from other circuits but not from each other

**A/D resolution** 24-bit

**Input accuracy** Sensor dependent, refer to Input Specifications table

**Measurement resolution** Sensor dependent, refer to Input Specifications table

**Maximum update rate** 10 rdg/s on each non-scanned input; 5 rdg/s when configured as 100 kΩ NTC RTD with reversal on; 2 rdg/s on each scanned input; update rate is dependent on the number of channels enabled (typically from 10 rdg/s for 1 channel to 2 rdg/s for all 10 scanned channels)

**Autorange** Automatically selects appropriate NTC RTD or PTC RTD range

**User curves** Room for 39 200-point CalCurves<sup>™</sup> or user curves

**SoftCal<sup>™</sup>** Improves accuracy of DT-470 diode to ±0.25 K from 30 K to 375 K; improves accuracy of platinum RTDs to ±0.25 K from 70 K to 325 K; stored as user curves

**Math** Maximum and minimum

**Filter** Averages 2 to 64 input readings

## Front panel

**Display** 8-line by 40-character (240 × 64 pixel) LCD display module with LED backlight

**Number of reading displays** 1 to 16

**Display units** K, °C, V, mV, Ω

**Reading source** Temperature, sensor units, max, and min

**Display update rate** 2 rdg/s

**Temperature display resolution** 0.0001° from 0° to 99.9999°, 0.001° from 100° to 999.999°, 0.01° above 1000°

**Sensor units display resolution** Sensor dependent, to 6 digits

**Other displays** Input name

**Display annunciators** Alarm

**LED annunciators** Remote, Ethernet status, alarm

**Keypad** 23-key silicone elastomer keypad

**Front panel features** Front-panel curve entry, display contrast control, and keypad lockout

## Interface

<b>Capabilities</b>	SH1, AH1, T5, L4, SR1, RL1, PP0, DC1, DT0, C0, E1
<b>Reading rate</b>	To 10 rdg/s on each input
<b>Software support</b>	LabVIEW <sup>™</sup> driver (see <a href="http://www.lakeshore.com">www.lakeshore.com</a> )

<b>Function</b>	Emulates a standard RS-232 serial port
<b>Baud rate</b>	57,600
<b>Connector</b>	B-type USB
<b>Reading rate</b>	To 10 rdg/s on each input

**Software support** LabVIEW<sup>™</sup> driver (see [www.lakeshore.com](http://www.lakeshore.com))

<b>Function</b>	TCP/IP, web interface with built-in utilities
<b>Connector</b>	RJ-45
<b>Reading rate</b>	To 10 rdg/s on each input
<b>Software support</b>	LabVIEW <sup>™</sup> driver (see <a href="http://www.lakeshore.com">www.lakeshore.com</a> )

<b>Number</b>	12, high and low for each input
<b>Data source</b>	Temperature or sensor units
<b>Settings</b>	Source, high setpoint, low setpoint, deadband, latching or non-latching, audible on/off, and visible on/off
<b>Actuators</b>	Display annunciator, beeper, and relays

<b>Number</b>	2
<b>Contacts</b>	Normally open (NO), normally closed (NC), and common (C)
<b>Contact rating</b>	30 VDC at 3 A
<b>Operation</b>	Activate relays on high, low, or both alarms for any input, or manual mode
<b>Connector</b>	Detachable terminal block

## General

**Ambient temperature** 15 °C to 35 °C at rated accuracy; 5 °C to 40 °C at reduced accuracy

**Power requirement** 100, 120, 220, 240 VAC, ±10%, 50 or 60 Hz, 35 VA

**Size** 435 mm W × 89 mm H × 368 mm D (17 in × 3.5 in × 14.5 in), full rack

**Weight** 7.6 kg (16.8 lb)

**Approval** CE mark, RoHS

## Ordering information

Part number	Description
224-12	Temperature monitor with 12 diode/RTD inputs—includes twelve 6-pin DIN plug sensor input mating connectors (G-106-233), one 6-pin terminal block (106-737), a calibration certificate and a user's manual

### Please indicate your power/cord configuration:

- 100 V—U.S. cord (NEMA 5-15)
- 120 V—U.S. cord (NEMA 5-15)
- 220 V—Euro cord (CEE 7/7)
- 240 V—Euro cord (CEE 7/7)
- 240 V—U.K. cord (BS 1363)
- 240 V—Swiss cord (SEV 1011)
- 220 V—China cord (GB 1002)

### Accessories

<b>RM-1</b>	Kit for mounting one full rack instrument
<b>G-106-233</b>	Sensor input mating connector (6-pin DIN plug)
<b>106-737</b>	Terminal block (6-pin)
<b>CAL-224-CERT</b>	Instrument calibration with certificate
<b>CAL-224-DATA</b>	Instrument recalibration with certificate and data
<b>119-062</b>	Model 224 temperature monitor user manual

All specifications are subject to change without notice





## Model 218 Temperature Monitor



### Model 218 features

- Operates down to 1.2 K with appropriate sensor
- 8 sensor inputs
- Supports diode and RTD sensors
- Continuous 8-input display with readings in K, °C, V, or  $\Omega$
- IEEE-488 and RS-232C interfaces, analog outputs, and alarm relays
- Available in two versions: Model 218S and 218E
- CE certification
- Full 3 year standard warranty





## Introduction

The Model 218 is our most versatile temperature monitor. With eight sensor inputs, it can be used with nearly any diode or resistive temperature sensor. It displays all eight channels continuously in K, °C, V or  $\Omega$ . The measurement input was designed for the demands of cryogenic temperature measurement, however, the monitor's low noise, high resolution, and wide operating range make it ideal for noncryogenic applications as well.

## Sensor input reading capability

The Model 218 has eight constant current sources (one for each input) that can be configured for a variety of sensors. The inputs can be configured from the front panel or via a computer interface, and are grouped in two sets of four. Each set of four inputs is configured for the same sensor type (i.e., all 100  $\Omega$  platinum or all silicon diodes).

Two high-resolution A/D converters increase the update rate of the Model 218. It can read sensor inputs more quickly than other scanning monitors because it does not have to wait for current source switching. The result is 16 new readings per second, allowing all inputs to be read twice each second. Inputs can be turned off to obtain a higher reading rate on fewer sensors.

## Temperature response curves

The Model 218 has standard temperature sensor response curves for silicon diodes and platinum RTDs. It can support a wide variety of temperature sensors because a unique 200-point user curve can be stored for each of the eight inputs. CalCurves™ for Lake Shore calibrated sensors can be stored as user curves.

The built in SoftCal™<sup>1</sup> algorithm can also be used to generate improved curves for DT-670 diodes and platinum RTDs that are stored as user curves.

## Interface

The Model 218 is available with both parallel (IEEE-488, 218S only) and serial (RS-232C) computer interfaces. Each input has a high and low alarm which offer latching and non-latching operation. The eight relays on the Model 218S can be used with the alarms to alert the operator of a fault condition or perform simple on-off control. The Model 218S includes two analog voltage outputs. The user may select the scale and data sent to the output, including temperature, sensor units, or linear equation results. Under manual control, the analog voltage output can also serve as a voltage source for other applications.

## Interface features of the Model 218S and Model 218E

	218S	218E
Numeric keypad	■	■
Front panel curve entry	■	■
Alarms	■	■
RS-232C interface	■	■
IEEE-488 interface	■	
Two analog voltage outputs	■	
Eight relays	■	

## Display

The eight display locations on the Model 218 are user configurable. Sources for readout data are temperature units, sensor units, and results of the math function. Input number and data source are always displayed for convenience. The display is updated twice each second.

<sup>1</sup> The Lake Shore SoftCal™ algorithm for silicon diode and platinum RTD sensors is a good solution for applications requiring more accuracy than a standard sensor curve but not in need of traditional calibration. SoftCal uses the predictability of a standard curve to improve the accuracy of an individual sensor around a few known temperature reference points.

## Model 218 rear panel

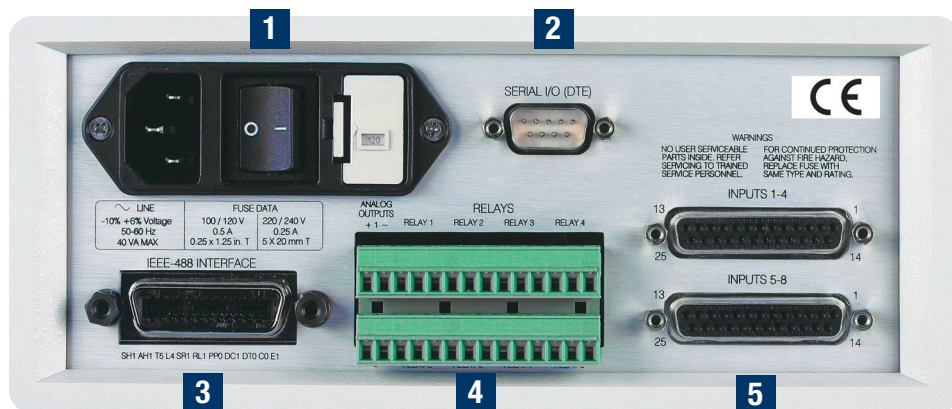

- 1 Line input assembly
- 2 RS-232C or printer interface
- 3 IEEE-488 interface (218S)
- 4 Terminal block with relays and analog voltage outputs (218S only)
- 5 Sensor inputs





## Sensor Selection

### Sensor temperature range (sensors sold separately)

		Model	Useful range	Magnetic field use
Diodes	Silicon diode	DT-670-SD	1.4 K to 500 K	$T \geq 60 \text{ K} \ \& \ B \leq 3 \text{ T}$
	Silicon diode	DT-670E-BR	30 K to 500 K	$T \geq 60 \text{ K} \ \& \ B \leq 3 \text{ T}$
	Silicon diode	DT-414	1.4 K to 375 K	$T \geq 60 \text{ K} \ \& \ B \leq 3 \text{ T}$
	Silicon diode	DT-421	1.4 K to 325 K	$T \geq 60 \text{ K} \ \& \ B \leq 3 \text{ T}$
	Silicon diode	DT-470-SD	1.4 K to 500 K	$T \geq 60 \text{ K} \ \& \ B \leq 3 \text{ T}$
	Silicon diode	DT-471-SD	10 K to 500 K	$T \geq 60 \text{ K} \ \& \ B \leq 3 \text{ T}$
	GaAlAs diode	TG-120-P	1.4 K to 325 K	$T > 4.2 \text{ K} \ \& \ B \leq 5 \text{ T}$
	GaAlAs diode	TG-120-PL	1.4 K to 325 K	$T > 4.2 \text{ K} \ \& \ B \leq 5 \text{ T}$
	GaAlAs diode	TG-120-SD	1.4 K to 500 K	$T > 4.2 \text{ K} \ \& \ B \leq 5 \text{ T}$
Positive temperature coefficient RTDs	100 $\Omega$ platinum	PT-102/3	14 K to 873 K	$T > 40 \text{ K} \ \& \ B \leq 2.5 \text{ T}$
	100 $\Omega$ platinum	PT-111	14 K to 673 K	$T > 40 \text{ K} \ \& \ B \leq 2.5 \text{ T}$
	Rhodium-iron	RF-800-4	1.4 K to 500 K	$T > 77 \text{ K} \ \& \ B \leq 8 \text{ T}$
	Rhodium-iron	RF-100T/U	1.4 K to 325 K	$T > 77 \text{ K} \ \& \ B \leq 8 \text{ T}$
Negative temperature coefficient RTDs <sup>2</sup>	Cernox <sup>®</sup>	CX-1010	2 K to 325 K <sup>5</sup>	$T > 2 \text{ K} \ \& \ B \leq 19 \text{ T}$
	Cernox <sup>®</sup>	CX-1030-HT	3.5 K to 420 K <sup>3,6</sup>	$T > 2 \text{ K} \ \& \ B \leq 19 \text{ T}$
	Cernox <sup>®</sup>	CX-1050-HT	4 K to 420 K <sup>3,6</sup>	$T > 2 \text{ K} \ \& \ B \leq 19 \text{ T}$
	Cernox <sup>®</sup>	CX-1070-HT	15 K to 420 K <sup>3</sup>	$T > 2 \text{ K} \ \& \ B \leq 19 \text{ T}$
	Cernox <sup>®</sup>	CX-1080-HT	50 K to 420 K <sup>3</sup>	$T > 2 \text{ K} \ \& \ B \leq 19 \text{ T}$
	Germanium	GR-300-AA	1.2 K to 100 K <sup>4</sup>	Not recommended
	Germanium	GR-1400-AA	4 K to 100 K <sup>4</sup>	Not recommended
	Rox <sup>™</sup>	RX-102A	1.4 K to 40 K <sup>5</sup>	$T > 2 \text{ K} \ \& \ B \leq 10 \text{ T}$

<sup>2</sup> Single excitation current may limit the low temperature range of NTC resistors

<sup>3</sup> Non-HT version maximum temperature: 325 K

<sup>4</sup> Low temperature limited by input resistance range

<sup>5</sup> Low temperature specified with self-heating error:  $\leq 5 \text{ mK}$

<sup>6</sup> Low temperature specified with self-heating error:  $\leq 12 \text{ mK}$

**Silicon diodes** are the best choice for general cryogenic use from 1.4 K to above room temperature. Diodes are economical to use because they follow a standard curve and are interchangeable in many applications. They are not suitable for use in ionizing radiation or magnetic fields.

**Cernox<sup>®</sup>** thin-film RTDs offer high sensitivity and low magnetic field-induced errors over the 2 K to 420 K temperature range. Cernox sensors require calibration.

**Platinum RTDs** offer high uniform sensitivity from 30 K to over 800 K. With excellent reproducibility, they are useful as thermometry standards. They follow a standard curve above 70 K and are interchangeable in many applications.



### Typical sensor performance—see Appendix F for sample calculations of typical sensor performance

	Example Lake Shore sensor	Temperature	Nominal resistance/voltage	Typical sensor sensitivity <sup>7</sup>	Measurement resolution: temperature equivalents	Electronic accuracy: temperature equivalents	Temperature accuracy including electronic accuracy, CalCurve™, and calibrated sensor
Silicon diode	DT-670-SD with 1.4H calibration	1.4 K	1.644 V	-12.49 mV/K	1.6 mK	±26 mK	±38 mK
		77 K	1.028 V	-1.73 mV/K	11.6 mK	±152 mK	±174 mK
		300 K	0.5597 V	-2.3 mV/K	8.7 mK	±94 mK	±126 mK
		500 K	0.0907 V	-2.12 mV/K	9.4 mK	±80 mK	±130 mK
Silicon diode	DT-470-SD-13 with 1.4H calibration	1.4 K	1.6981 V	-13.1 mV/K	1.5 mK	±26 mK	±38 mK
		77 K	1.0203 V	-1.92 mV/K	10.5 mK	±137 mK	±159 mK
		300 K	0.5189 V	-2.4 mV/K	8.4 mK	±88 mK	±120 mK
		475 K	0.0906 V	-2.22 mV/K	9.1 mK	±77 mK	±127 mK
GaAlAs diode	TG-120-SD with 1.4H calibration	1.4 K	5.391 V	-97.5 mV/K	0.2 mK	±13 mK	±25 mK
		77 K	1.422 V	-1.24 mV/K	16.2 mK	±359 mK	±381 mK
		300 K	0.8978 V	-2.85 mV/K	7 mK	±120 mK	±152 mK
		475 K	0.3778 V	-3.15 mV/K	6.4 mK	±75 mK	±125 mK
100 Ω platinum RTD 500 Ω full scale	PT-103 with 1.4J calibration	30 K	3.66 Ω	0.19 Ω/K	10.5 mK	±25 mK	±35 mK
		77 K	20.38 Ω	0.42 Ω/K	4.8 mK	±20 mK	±32 mK
		300 K	110.35 Ω	0.39 Ω/K	5.2 mK	±68 mK	±91 mK
		500 K	185.668 Ω	0.378 Ω/K	5.3 mK	±109 mK	±155 mK
Cernox®	CX-1050-SD-HT <sup>8</sup> with 4M calibration	4.2 K	3507.2 Ω	-1120.8 Ω/K	45 μK	±1.4 mK	±6.4 mK
		77 K	205.67 Ω	-2.4116 Ω/K	20.8 mK	±75.6 mK	±91.6 mK
		300 K	59.467 Ω	-0.1727 Ω/K	290 mK	±717 mK	±757 mK
		420 K	45.03 Ω	-0.0829 Ω/K	604 mK	±1.43 K	±1.5 K
Germanium	GR-300-AA with 0.3D calibration	1.2 K	600 Ω	-987 Ω/K	51 μK	±0.3 mK	±4.5 mK
		1.4 K	449 Ω	-581 Ω/K	86 μK	±0.5 mK	±4.7 mK
		4.2 K	94 Ω	-27 Ω/K	1.9 mK	±5.2 mK	±10.2 mK
		100 K	3 Ω	-0.024 Ω/K	2.10 K	±4.25 K	±4.27 K
Germanium	GR-1400-AA with 1.4D calibration	4 K	1873 Ω	-1008 Ω/K	50 μK	±0.8 mK	±5.0 mK
		4.2 K	1689 Ω	-862 Ω/K	58 μK	±0.9 mK	±5.1 mK
		10 K	253 Ω	-62 Ω/K	807 μK	±3.2 mK	±8.2 mK
		100 K	3 Ω	-0.021 Ω/K	2.40 K	±4.86 K	±4.88 K
Carbon-glass (no longer available)	CGR-1-2000 with 4L calibration	4.2 K	2260 Ω	-2060 Ω/K	25 μK	±0.5 mK	±4.5 mK
		77 K	21.65 Ω	-0.157 Ω/K	319 mK	±692 mK	±717 mK
		300 K	11.99 Ω	-0.015 Ω/K	3.33 K	±7 K	±7.1 K

<sup>7</sup> Typical sensor sensitivities were taken from representative calibrations for the sensor listed

<sup>8</sup> Non-HT version maximum temperature: 325 K

## Specifications

### Thermometry

#### Number of inputs 8

**Input configuration** Inputs separated into two groups of four (each group must be the same sensor type) – inputs can be configured from the front panel to accept any of the supported input types

**Input accuracy** Sensor dependent—refer to Input Specifications table

**Measurement resolution** Sensor dependent—refer to Input Specifications table

**Maximum update rate** 16 readings per s total

**User curves** Room for 8 (1 per input) 200-point CalCurves™ or user curves

**SoftCal™** Improves accuracy of DT-470 diode to ±0.25 K from 30 K to 375 K; improves accuracy of platinum RTDs to ±0.25 K from 70 K to 325 K; stored as user curves

**Math** Maximum, minimum, and linear equation (Mx + B) or M(x + B)

**Filter** Averages 2 to 64 input readings

### Front panel

**Display** 4 line by 20 character backlit LCD display

**Number of reading displays** 1 to 8

**Display units** K, °C, V, and Ω

**Reading source** Temperature, sensor units, max, min, and linear equation

**Display update rate** All displayed inputs twice in 1 s

**Temp display resolution** 0.001° from 0° to 99.999°, 0.01° from 100° to 999.99°, 0.1° above 1000°

**Sensor units display resolution** Sensor dependent to 5 digits

**Display annunciators** Remote operation, alarm, data logging, max, min, and linear

**Keypad** Membrane keypad, 20-key, numeric and specific functions

**Front panel features** Front panel curve entry and keypad lock-out



## Input specifications

Sensor temperature coefficient		Input range	Excitation current	Display resolution	Measurement resolution	Electronic accuracy
Diode	negative	0 V to 2.5 V	10 $\mu$ A $\pm$ 0.05% <sup>9</sup>	100 $\mu$ V	20 $\mu$ V	$\pm$ 160 $\mu$ V $\pm$ 0.01% of rdg
		0 V to 7.5 V	10 $\mu$ A $\pm$ 0.05% <sup>9</sup>	100 $\mu$ V	20 $\mu$ V	$\pm$ 160 $\mu$ V $\pm$ 0.02% of rdg
PTC RTD	positive	0 $\Omega$ to 250 $\Omega$	1 mA $\pm$ 0.3% <sup>10</sup>	10 m $\Omega$	2 m $\Omega$	$\pm$ 0.004 $\Omega$ $\pm$ 0.02% of rdg
		0 $\Omega$ to 500 $\Omega$	1 mA $\pm$ 0.3% <sup>10</sup>	10 m $\Omega$	2 m $\Omega$	$\pm$ 0.004 $\Omega$ $\pm$ 0.02% of rdg
		0 $\Omega$ to 5000 $\Omega$	1 mA $\pm$ 0.3% <sup>10</sup>	100 m $\Omega$	20 m $\Omega$	$\pm$ 0.06 $\Omega$ $\pm$ 0.04% of rdg
NTC RTD	negative	0 $\Omega$ to 7500 $\Omega$	10 $\mu$ A $\pm$ 0.05% <sup>9</sup>	100 m $\Omega$	50 m $\Omega$	$\pm$ 0.1 $\Omega$ $\pm$ 0.04% of rdg

<sup>9</sup> Current source error has negligible effect on measurement accuracy

<sup>10</sup> Current source error is removed during calibration

## Sensor input configuration

Diode/RTD	
Measurement type	4-lead differential
Excitation	8 constant current sources
Supported sensors	Diodes: Silicon, GaAlAs RTDs: 100 $\Omega$ Platinum, 1000 $\Omega$ Platinum, Germanium, Carbon-Glass, Cernox <sup>®</sup> , and Rox <sup>™</sup>
Standard curves	DT-470, DT-500D, DT-670, CTI-C, PT-100, and PT-1000
Input connector	25-pin D-sub

## Interface

### IEEE-488.2 interface (218S)

Features	SH1, AH1, T5, L4, SR1, RL1, PPO, DC1, DTO, C0, E1
Reading rate	To 16 rdg/s
Software support	LabVIEW <sup>™</sup> driver

### Serial interface

Electrical format	RS-232C
Max baud rate	9600 baud
Connector	9-pin D-sub
Reading rate	To 16 readings per s (at 9600 baud)
Printer capability	Support for serial printer through serial interface port used with data log parameters

### Alarms

Number	16: high and low for each input
Data source	Temperature, sensor units, and linear equation
Settings	Source, high setpoint, low setpoint, deadband, latching or non-latching, and audible on/off
Actuators	Display annunciator, beeper, and relays (218S)

### Relays (218S)

Number	8
Contacts	Normally open (NO), normally closed (NC), and common (C)
Contact rating	30 VDC at 5 A
Operation	Each input may be configured to activate any or all of the eight relays—relays may be activated on high, low, or both alarms for any input, or manually
Connector	Detachable terminal block

### Analog voltage output (218S)

Number	2
Scale	User selected
Update rate	To 16 rdg/s
Data source	Temperature, sensor units, and linear equation
Range	$\pm$ 10 V
Resolution	1.25 mV
Accuracy	$\pm$ 2.5 mV
Min load resistance	1 k $\Omega$ (short-circuit protected)

### Data logging

Channels	1 to 8
Operation	Data log records can be stored in memory or sent to the printer; stored data may be displayed, printed, or retrieved by computer interface
Data memory	Maximum of 1500 single reading records, non-volatile

## General

**Ambient temperature** 15 °C to 35 °C at rated accuracy, 10 °C to 40 °C at reduced accuracy

**Power requirement** 100, 120, 220, 240 VAC, (+6%, -10%), 50 or 60 Hz, 18 VA

**Size** 216 mm W  $\times$  89 mm H  $\times$  318 mm D (8.5 in  $\times$  3.5 in  $\times$  12.5 in), half rack

**Weight** 3 kg (6.6 lb)

**Approval** CE mark, RoHS

## Ordering information

### Part number Description

<b>218S</b>	Standard temperature monitor (8 inputs, IEEE-488 and serial interface, alarms, relays, corrected analog output, data logging)—includes two 25-pin D-sub sensor input plugs (G-106-253), two 25-pin D-sub sensor input shells (G-106-264), two 14-pin relay/analog output connectors (106-772), a calibration certificate and a user's manual
<b>218E</b>	Economy temperature monitor (8 inputs, serial interface, alarms, data logging)—includes same accessories as the 218S

### Please indicate your power/cord configuration:

- 100 V—U.S. cord (NEMA 5-15)
- 120 V—U.S. cord (NEMA 5-15)
- 220 V—Euro cord (CEE 7/7)
- 240 V—Euro cord (CEE 7/7)
- 240 V—U.K. cord (BS 1363)
- 240 V—Swiss cord (SEV 1011)
- 220 V—China cord (GB 1002)

### Accessories

<b>4005</b>	1 m IEEE-488 (GPIB) computer interface cable assembly—includes extender which allows connection of IEEE cable and relay terminal block simultaneously
<b>RM-1/2</b>	Kit for mounting one half rack instrument
<b>RM-2</b>	Kit for mounting two half rack instruments
<b>G-106-253</b>	DB-25 plug, qty 1
<b>G-106-264</b>	DB-25 hood, qty 1
<b>106-772</b>	Terminal block mating connector, 14-pin connector, 218S only
<b>8000</b>	The CalCurve <sup>™</sup> breakpoint table from a calibrated sensor loaded on a CD-ROM for customer uploading
<b>8002-05-218</b>	The breakpoint table from a calibrated sensor stored in a NOVRAM for installation at the customer location
<b>CAL-218-CERT</b>	Instrument calibration with certificate
<b>CAL-218-DATA</b>	Instrument recalibration with certificate and data
<b>119-007</b>	Model 218 temperature monitor manual

All specifications are subject to change without notice





## Model 211 Temperature Controller



### Model 211 features

- Operates down to 1.2 K with appropriate sensor
- One sensor input
- Supports diode and RTD sensors
- 0 V to 10 V or 4 mA to 20 mA output
- Large 5-digit LED display
- RS-232C serial interface and alarm relays
- CE certification
- Full 3 year standard warranty





### Introduction

The Lake Shore single-channel Model 211 temperature monitor provides the accuracy, resolution, and interface features of a benchtop temperature monitor in an easy to use, easily integrated, compact instrument. With appropriate sensors, it measures from 1.2 K to 873 K, including temperatures in high vacuum and magnetic fields. Alarms, relays, user-configurable analog voltage or current output, and a serial interface are standard features on the Model 211. It is a good choice for liquefied gas storage and monitoring, cryopump control, cryo-cooler, and materials science applications, and when you need greater accuracy than thermocouples allow.

### Sensor input reading capability

The Model 211 temperature monitor supports diode temperature sensors and resistance temperature detectors (RTDs). It can be configured for the type of sensor in use from the instrument front panel. Ensuring high accuracy and 5-digit measurement resolution are 4-lead differential measurement and 24-bit analog-to-digital conversion.

The Model 211 converts voltage or resistance to temperature units based on temperature response curve data for the sensor in use. Standard temperature response curves for silicon diodes and platinum RTDs are included in instrument firmware. It also provides non-volatile memory for one 200-point temperature response curve, which can be entered via the serial interface.

### Interface

With an RS-232C serial interface and other interface features, the Model 211 is valuable as a stand-alone monitor and is easily integrated into other systems. Setup and every instrument function can be performed via serial interface or the front panel. Temperature data can be read up to seven times per second over computer interface; the display is updated twice each second. High and low alarms can be used in latching mode for error limit detection and in non-latching mode in conjunction with relays to perform simple on-off control functions. The analog output can be configured for either 0 to 10 V or 4 to 20 mA output.

### Sensor Selection

#### Sensor temperature range (sensors sold separately)

		Model	Useful range	Magnetic field use
Diodes	Silicon diode	DT-670-SD	1.4 K to 500 K	$T \geq 60 \text{ K} \ \& \ B \leq 3 \text{ T}$
	Silicon diode	DT-670E-BR	30 K to 500 K	$T \geq 60 \text{ K} \ \& \ B \leq 3 \text{ T}$
	Silicon diode	DT-414	1.4 K to 375 K	$T \geq 60 \text{ K} \ \& \ B \leq 3 \text{ T}$
	Silicon diode	DT-421	1.4 K to 325 K	$T \geq 60 \text{ K} \ \& \ B \leq 3 \text{ T}$
	Silicon diode	DT-470-SD	1.4 K to 500 K	$T \geq 60 \text{ K} \ \& \ B \leq 3 \text{ T}$
	Silicon diode	DT-471-SD	10 K to 500 K	$T \geq 60 \text{ K} \ \& \ B \leq 3 \text{ T}$
	GaAlAs diode	TG-120-P	1.4 K to 325 K	$T > 4.2 \text{ K} \ \& \ B \leq 5 \text{ T}$
	GaAlAs diode	TG-120-PL	1.4 K to 325 K	$T > 4.2 \text{ K} \ \& \ B \leq 5 \text{ T}$
	GaAlAs diode	TG-120-SD	1.4 K to 500 K	$T > 4.2 \text{ K} \ \& \ B \leq 5 \text{ T}$
Positive temperature coefficient RTDs	100 $\Omega$ platinum	PT-102/3	14 K to 873 K	$T > 40 \text{ K} \ \& \ B \leq 2.5 \text{ T}$
	100 $\Omega$ platinum	PT-111	14 K to 673 K	$T > 40 \text{ K} \ \& \ B \leq 2.5 \text{ T}$
	Rhodium-iron	RF-800-4	1.4 K to 500 K	$T > 77 \text{ K} \ \& \ B \leq 8 \text{ T}$
	Rhodium-iron	RF-100T/U	1.4 K to 325 K	$T > 77 \text{ K} \ \& \ B \leq 8 \text{ T}$
Negative temperature coefficient RTDs <sup>1</sup>	Cernox <sup>®</sup>	CX-1010	2 K to 325 K <sup>4</sup>	$T > 2 \text{ K} \ \& \ B \leq 19 \text{ T}$
	Cernox <sup>®</sup>	CX-1030-HT	3.5 K to 420 K <sup>2,5</sup>	$T > 2 \text{ K} \ \& \ B \leq 19 \text{ T}$
	Cernox <sup>®</sup>	CX-1050-HT	4 K to 420 K <sup>2,5</sup>	$T > 2 \text{ K} \ \& \ B \leq 19 \text{ T}$
	Cernox <sup>®</sup>	CX-1070-HT	15 K to 420 K <sup>2</sup>	$T > 2 \text{ K} \ \& \ B \leq 19 \text{ T}$
	Cernox <sup>®</sup>	CX-1080-HT	50 K to 420 K <sup>2</sup>	$T > 2 \text{ K} \ \& \ B \leq 19 \text{ T}$
	Germanium	GR-300-AA	1.2 K to 100 K <sup>3</sup>	Not recommended
	Germanium	GR-1400-AA	4 K to 100 K <sup>3</sup>	Not recommended
Rox <sup>™</sup>	RX-102A	1.4 K to 40 K <sup>4</sup>	$T > 2 \text{ K} \ \& \ B \leq 10 \text{ T}$	

<sup>1</sup> Single excitation current may limit the low temperature range of NTC resistors

<sup>2</sup> Non-HT version maximum temperature: 325 K

<sup>3</sup> Low temperature limited by input resistance range

<sup>4</sup> Low temperature specified with self-heating error:  $\leq 5 \text{ mK}$

<sup>5</sup> Low temperature specified with self-heating error:  $\leq 12 \text{ mK}$

**Silicon diodes** are the best choice for general cryogenic use from 1.4 K to above room temperature. Diodes are economical to use because they follow a standard curve and are interchangeable in many applications. They are not suitable for use in ionizing radiation or magnetic fields.

**Cernox<sup>®</sup>** thin-film RTDs offer high sensitivity and low magnetic field-induced errors over the 2 K to 420 K temperature range. Cernox sensors require calibration.

**Platinum RTDs** offer high uniform sensitivity from 30 K to over 800 K. With excellent reproducibility, they are useful as thermometry standards. They follow a standard curve above 70 K and are interchangeable in many applications.

### Model 211 rear panel

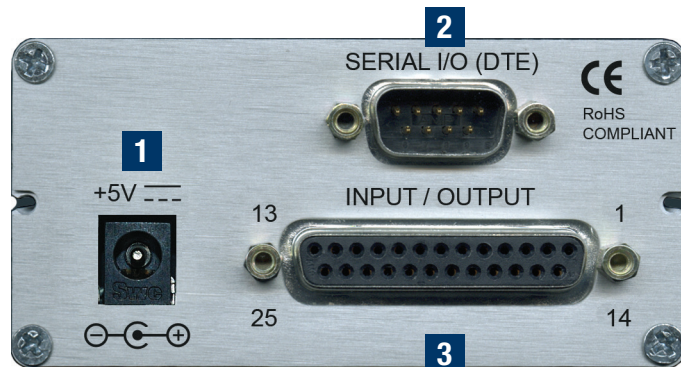

1 Power input connector

2 Serial (RS-232C) I/O (DTE)

3 Analog output



## Display

The Model 211 has a 6-digit LED display with measurements available in temperature units K, °C, °F, or sensor units V or  $\Omega$ .

## Specifications

### Sensor input configuration

Diode/RTD	
Measurement type	4-lead differential
Excitation	8 constant current sources
Supported sensors	Diodes: silicon, GaAlAs RTDs: 100 $\Omega$ platinum, 1000 $\Omega$ platinum, germanium, carbon-glass, Cernox®, and Rox™
Standard curves	DT-470, DT-670, CTI-C, PT-100, and PT-1000
Input connector	Shared 25-pin D-sub

## Thermometry

### Number of inputs 1

**Input configuration** Input can be configured from the front panel to accept any of the supported input types

**Isolation** Measurement is not isolated from chassis ground

**A/D resolution** 24-bit

**Input accuracy** Sensor dependent—refer to Input Specifications table

**Measurement resolution** Sensor dependent—refer to Input Specifications table

**Maximum update rate** 7 rdg/s

**User curve** One 200-point CalCurve™ or user curve in non-volatile memory

### Front panel

**Display** 5-digit LED

**Number of reading displays** 1

**Display units** K, °C, °F, V, and  $\Omega$

**Reading source** Temperature and sensor units

**Display update rate** 2 rdg/s

**Temp display resolution** 0.001° from 0° to 99.999°, 0.01° from 100° to 999.99°, 0.1° above 1000°

**Sensor units display resolution** Sensor dependent to 5 digits

**Display annunciators** K, °C, °F, and V/ $\Omega$

**Keypad** 4 full travel keys, numeric and specific functions

**Front panel features** Display brightness control, keypad lock-out

### Typical sensor performance—see Appendix F for sample calculations of typical sensor performance

Example Lake Shore sensor		Temperature	Nominal resistance/voltage	Typical sensor sensitivity <sup>6</sup>	Measurement resolution: temperature equivalents	Electronic accuracy: temperature equivalents	Temperature accuracy including electronic accuracy, CalCurve™, and calibrated sensor
Silicon diode	DT-670-SD with 1.4H calibration	1.4 K	1.644 V	-12.49 mV/K	1.6 mK	±29 mK	±41 mK
		77 K	1.028 V	-1.73 mV/K	11.6 mK	±175 mK	±197 mK
		300 K	0.5597 V	-2.3 mV/K	8.7 mK	±111 mK	±143 mK
		500 K	0.0907 V	-2.12 mV/K	9.4 mK	±99 mK	±149 mK
Silicon diode	DT-470-SD-13 with 1.4H calibration	1.4 K	1.6981 V	-13.1 mV/K	1.5 mK	±28 mK	±40 mK
		77 K	1.0203 V	-1.92 mV/K	10.5 mK	±157 mK	±179 mK
		300 K	0.5189 V	-2.4 mV/K	8.4 mK	±105 mK	±137 mK
		475 K	0.0906 V	-2.22 mV/K	9.1 mK	±94 mK	±144 mK
GaAlAs diode	TG-120-SD with 1.4H calibration	1.4 K	5.391 V	-97.5 mV/K	0.2 mK	±15 mK	±27 mK
		77 K	1.422 V	-1.24 mV/K	16.2 mK	±512 mK	±534 mK
		300 K	0.8978 V	-2.85 mV/K	7 mK	±186 mK	±218 mK
		475 K	0.3778 V	-3.15 mV/K	6.4 mK	±135 mK	±185 mK
100 $\Omega$ platinum RTD 500 $\Omega$ full scale	PT-103 with 1.4J calibration	30 K	3.66 $\Omega$	0.19 $\Omega$ /K	10.5 mK	±320 mK	±330 mK
		77 K	20.38 $\Omega$	0.42 $\Omega$ /K	4.8 mK	±153 mK	±165 mK
		300 K	110.35 $\Omega$	0.39 $\Omega$ /K	5.2 mK	±210 mK	±232 mK
		500 K	185.668 $\Omega$	0.378 $\Omega$ /K	5.3 mK	±257 mK	±303 mK
Cernox®	CX-1050-SD-HT <sup>7</sup> with 4M calibration	4.2 K	3507.2 $\Omega$	-1120.8 $\Omega$ /K	45 $\mu$ K	±2.0 mK	±7.0 mK
		77 K	205.67 $\Omega$	-2.4116 $\Omega$ /K	20.8 mK	±366 mK	±382 mK
		300 K	59.467 $\Omega$	-0.1727 $\Omega$ /K	290 mK	±4.8 K	±4.8 K
		420 K	45.03 $\Omega$	-0.0829 $\Omega$ /K	604 mK	±9.9 K	±9.9 K
Germanium	GR-300-AA with 0.3D calibration	1.2 K	600 $\Omega$	-987 $\Omega$ /K	51 $\mu$ K	±0.6 mK	±5.3 mK
		1.4 K	449 $\Omega$	-581 $\Omega$ /K	86 $\mu$ K	±1 mK	±5 mK
		4.2 K	94 $\Omega$	-27 $\Omega$ /K	1.9 mK	±16 mK	±20 mK
		100 K	3 $\Omega$	-0.024 $\Omega$ /K	2.10 K	±2.5 K	±2.5 K
Germanium	GR-1400-AA with 1.4D calibration	4 K	1873 $\Omega$	-1008 $\Omega$ /K	50 $\mu$ K	±1.1 mK	±5.1 mK
		4.2 K	1689 $\Omega$	-862 $\Omega$ /K	58 $\mu$ K	±1.2 mK	±5.2 mK
		10 K	253 $\Omega$	-62 $\Omega$ /K	807 $\mu$ K	±1.8 mK	±6.3 mK
		100 K	3 $\Omega$	-0.021 $\Omega$ /K	2.40 K	±2.9 K	±2.9 K
Carbon-glass (no longer available)	CGR-1-2000 with 4L calibration	4.2 K	2260 $\Omega$	-2060 $\Omega$ /K	25 $\mu$ K	±0.6 mK	±4.6 mK
		77 K	21.65 $\Omega$	-0.157 $\Omega$ /K	319 mK	±410 mK	±435 mK
		300 K	11.99 $\Omega$	-0.015 $\Omega$ /K	3.33 K	±4.2 K	±4.2 K

<sup>6</sup> Typical sensor sensitivities were taken from representative calibrations for the sensor listed

<sup>7</sup> Non-HT version maximum temperature: 325 K



**Input specifications**

Sensor type	Sensor temperature coefficient	Input range	Excitation current	Display resolution	Measurement resolution	Electronic accuracy	Instrument temperature coefficient
Silicon diode	negative	0 V to 2.5 V	10 $\mu$ A $\pm$ 0.05% <sup>8</sup>	100 $\mu$ V	20 $\mu$ V	$\pm$ 200 $\mu$ V $\pm$ 0.01% of rdg	$\pm$ 10 $\mu$ V $\pm$ 5 PPM of rdg/ $^{\circ}$ C
GaAlAs diode	negative	0 V to 7.5 V	10 $\mu$ A $\pm$ 0.05% <sup>8</sup>	100 $\mu$ V	20 $\mu$ V	$\pm$ 350 $\mu$ V $\pm$ 0.02% of rdg	$\pm$ 20 $\mu$ V $\pm$ 5 PPM of rdg/ $^{\circ}$ C
100 $\Omega$ platinum RTD, 250 $\Omega$ full scale	positive	0 $\Omega$ to 250 $\Omega$	1 mA $\pm$ 0.3% <sup>9</sup>	10 m $\Omega$	2 m $\Omega$	$\pm$ 0.06 $\Omega$ $\pm$ 0.02% of rdg	$\pm$ 0.2 m $\Omega$ $\pm$ 5 PPM of rdg/ $^{\circ}$ C
100 $\Omega$ platinum RTD, 500 $\Omega$ full scale	positive	0 $\Omega$ to 500 $\Omega$	1 mA $\pm$ 0.3% <sup>9</sup>	10 m $\Omega$	2 m $\Omega$	$\pm$ 0.06 $\Omega$ $\pm$ 0.02% of rdg	$\pm$ 0.2 m $\Omega$ $\pm$ 5 PPM of rdg/ $^{\circ}$ C
1000 $\Omega$ platinum RTD	positive	0 $\Omega$ to 5000 $\Omega$	1 mA $\pm$ 0.3% <sup>9</sup>	100 m $\Omega$	20 m $\Omega$	$\pm$ 0.4 $\Omega$ $\pm$ 0.04% of rdg	$\pm$ 2.0 m $\Omega$ $\pm$ 5 PPM of rdg/ $^{\circ}$ C
Cernox <sup>®</sup> RTD	negative	0 $\Omega$ to 7500 $\Omega$	10 $\mu$ A $\pm$ 0.05% <sup>8</sup>	100 m $\Omega$	50 m $\Omega$	$\pm$ 0.8 $\Omega$ $\pm$ 0.04% of rdg	$\pm$ 20 m $\Omega$ $\pm$ 15 PPM of rdg/ $^{\circ}$ C

<sup>8</sup> Current source error has negligible effect on measurement accuracy

<sup>9</sup> Current source error is removed during calibration

**Interface**

**Serial interface**

<b>Electrical format</b>	RS-232C
<b>Max baud rate</b>	9600 baud
<b>Connector</b>	9-pin D-sub
<b>Reading rate</b>	Up to 7 rdg/s

**Alarms**

<b>Number</b>	2, high and low
<b>Data source</b>	Temperature
<b>Settings</b>	High setpoint, Low setpoint, Dead band, Latching or Non-latching
<b>Actuators</b>	Display message, relays

**Relays**

<b>Number</b>	2
<b>Contacts</b>	Normally Open (NO), Normally Closed (NC), and Common (C)
<b>Contact rating</b>	30 VDC at 1 A
<b>Operation</b>	Activate relays on high or low input alarm or manual
<b>Connector</b>	Shared 25-pin D-sub

**Analog output**

**Isolation** Output is not isolated from chassis ground

<b>Update rate</b>	7 readings per s
<b>Data source</b>	Temperature

	Voltage	Current
<b>Range</b>	0 V to 10 V	4 mA to 20 mA
<b>Accuracy</b>	$\pm$ 1.25 mV	$\pm$ 5.0 $\mu$ A
<b>Resolution</b>	0.3 mV	0.6 $\mu$ A
<b>Min load resistance</b>	500 $\Omega$	NA
<b>Compliance voltage</b>	NA	10 V
<b>Load regulation</b>	NA	$\pm$ 0.02% of reading 0 to 500 $\Omega$

	Temperature	Sensor units (fixed by type)
Scales:	0 K to 20 K	Diodes: 1 V = 1 V
	0 K to 100 K	100 $\Omega$ platinum: 1 V = 100 $\Omega$
	0 K to 200 K	1000 $\Omega$ platinum: 1 V = 1000 $\Omega$
	0 K to 325 K	NTC resistor: 1 V = 1000 $\Omega$
	0 K to 475 K	
	0 K to 1000 K	

**Settings** Voltage or current, scale

**Connector** Shared 25-pin D-sub

**General**

**Ambient temperature** 15  $^{\circ}$ C to 35  $^{\circ}$ C at rated accuracy, 10  $^{\circ}$ C to 40  $^{\circ}$ C at reduced accuracy

**Power requirements** Regulated +5 VDC at 400 mA

**Size** 96 mm W  $\times$  48 mm H  $\times$  166 mm D (3.8 in  $\times$  1.9 in  $\times$  6.5 in)

**Mounting** Panel mount into 91 mm W  $\times$  44 mm H (3.6 in  $\times$  1.7 in) cutout

**Weight** 0.45 kg (1 lb)

**Approvals** CE mark, RoHS



**2111** Single 1/4 DIN panel-mount adapter, 105 mm W  $\times$  132 mm H (4.1 in  $\times$  5.2 in)



**2112** Dual 1/4 DIN panel-mount adapter, 105 mm W  $\times$  132 mm H (4.1 in  $\times$  5.2 in)

**Power supply (109-132)**

**Comes standard with interchangeable input plugs**

**Power requirements** 100 to 240 VAC, 50 or 60 Hz, 0.3 A max

**Output** +5 V at 1.2 A

**Size** 40.5 mm W  $\times$  30 mm H  $\times$  64 mm D (1.6 in  $\times$  1.2 in  $\times$  2.5 in)

**Weight** 0.15 kg (0.33 lb)

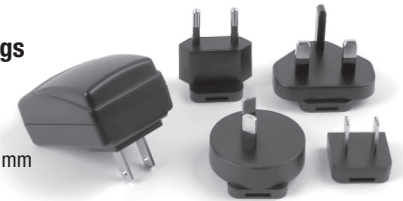

**Ordering information**

Part number	Description
<b>211S</b>	Model 211 single channel temperature monitor—includes 100 to 240 V, 6 W universal power supply with interchangeable input plugs (109-132), one DB-25 sensor input mating connector (G-106-253), one sensor input mating connector shell (G-106-264), a calibration certificate and a user's manual Model 211S with all accessories except the power supply
<b>211N</b>	
<b>Accessories</b>	
<b>109-132</b>	100-240 VAC power supply with interchangeable plugs for US, UK, Europe, Australia, and China application
<b>2111</b>	Single 1/4 DIN panel-mount adapter
<b>2112</b>	Dual 1/4 DIN panel-mount adapter
<b>G-106-253</b>	DB-25 plug; qty 1
<b>G-106-264</b>	DB-25 hood; qty 1
<b>CAL-211-CERT</b>	Instrument recalibration with certificate
<b>CAL-211-DATA</b>	Instrument recalibration with certificate and data
<b>119-043</b>	Model 211 temperature monitor manual

All specifications are subject to change without notice





## Model 121 Programmable Current Source



### Model 121 features

- 6 decades of output current, selectable in 13 ranges
- Programmable current output, 100 nA to 100 mA
- Low-noise output
- Large 3 digit LED display
- Simple user interface
- Current reversal feature
- USB interface enables integration with automated test systems
- DIN panel mountable package
- Detachable output terminal block
- CE certification
- Full 3 year standard warranty







## Introduction

The Model 121 programmable current source is a precision instrument suitable for bench-top use or panel-mounted operation in labs, test facilities, and manufacturing environments. It provides a low noise, highly-stable source of current up to 100 mA, with convenient manual selection through 13 pre-set output levels, each representing a ten-fold change in power when attached to a resistive load. A “user” setting allows the current output to be defined anywhere within the operating range of the unit, from 100 nA to 100 mA.

Fully automated operation is also possible via the instrument’s USB computer interface, through which the Model 121 can be commanded to output any desired current at any time. Thus, application-specific test patterns can be created.

The instrument operates at 5 VDC, and power is supplied by the external AC wall-mount supply provided with the standard Model 121. The supply will automatically conform to any AC line voltage ranging from 100 VAC to 240 VAC, 50 to 60 Hz.

## Applications

The Model 121 current source is ideally suited for testing, measuring, and operating resistive and semiconductor devices, such as:

- Lake Shore Cernox® temperature sensors
- Other resistance temperature detectors (RTDs) such as platinum sensors
- Diode temperature sensors, including Lake Shore DT-670s
- LED devices
- Hall sensors used for magnetic field measurement

An accurate, stable source of current is key to ensuring consistent operation of these devices, where the voltage drop across the device can be dependent upon temperature, magnetic field, and other parameters. The instrument’s wide output range is of great value when used with RTD-type sensors whose resistance can vary with temperature by as much as 6 orders of magnitude. The current reversal feature enables compensation for thermal EMF, important for accurately measuring resistors at very low excitation levels. Example applications include:

- Basic device QC (“good/bad” verification)
- LED brightness testing (constant device current)
- Temperature sensor calibration (determine resistance at fixed calibration points)
- Temperature measurement (using a voltmeter readout)
- Magnetic sensor calibration and measurement
- Semiconductor device measurements (IV curves for diodes, transistors, etc.)
- Circuit prototyping (fixed current source)
- Small scale electro-chemical applications

## Model 121 rear panel

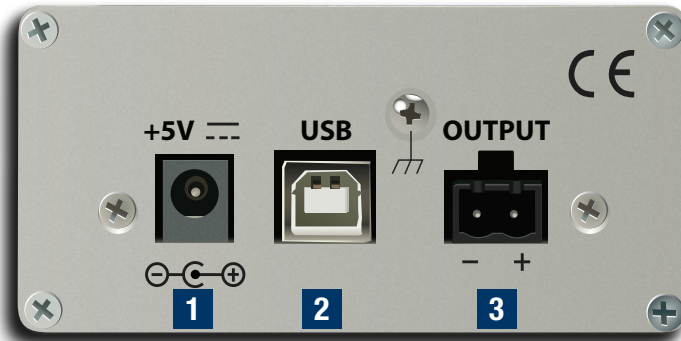

- 1 Power input connector
- 2 USB interface
- 3 Output current

Whether operating over a wide range of environmental conditions, establishing precise sensor calibrations or simply testing devices for conformance, the Model 121 provides a convenient and reliable alternative to simple voltage-based circuits, and a very affordable alternative to more expensive multi-function current sources. It can be readily integrated into automated test systems using its built-in USB computer interface and offers a highly readable, simple-to-use operator display.



Model 121 possible applications

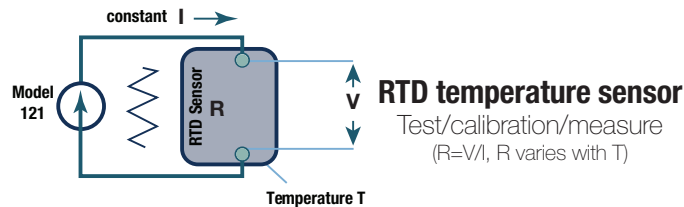
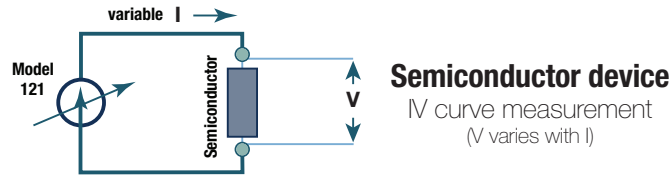
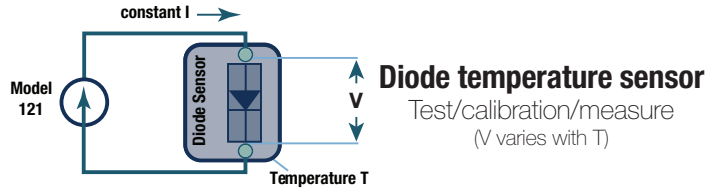
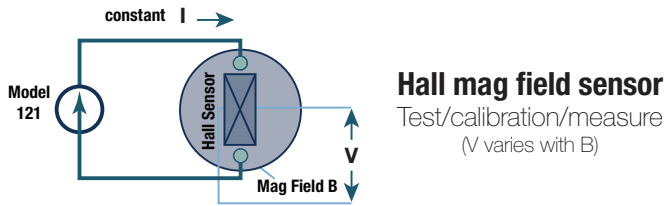

Application range of Model 121

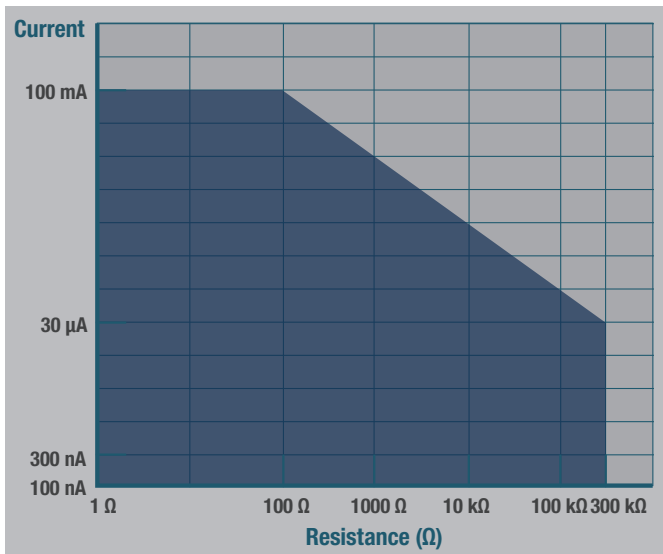

Using the Model 121 with a resistive device/sensor

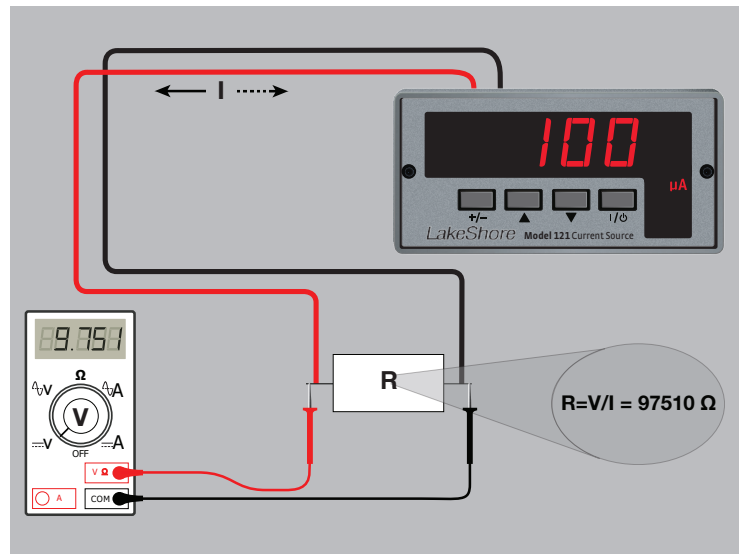



## Output

**Type:** Bipolar, DC current source

**Current ranges:** 13 fixed ranges of 100 nA, 300 nA, 1  $\mu$ A, 3  $\mu$ A, 10  $\mu$ A, 30  $\mu$ A, 100  $\mu$ A, 300  $\mu$ A, 1 mA, 3 mA, 10 mA, 30 mA, 100 mA, plus a user programmable range

**Accuracy:** 0.05% on 10  $\mu$ A range, 0.5% on 100 nA and 300 nA ranges, 0.1% on all other ranges

**Compliance voltage:**  $\pm 11$  V up to 30 mA, 10 V up to 100 mA

**AC current ripple:** Less than 0.1% on 100 nA and 300 nA ranges, Less than 0.01% on all other ranges in properly shielded system

**Current ripple frequency:** Dominated by the switching power supply line frequency/harmonics

**Temperature coefficient:** 0.03% of range/ $^{\circ}$ C for the 100 nA range, 0.01% of range/ $^{\circ}$ C for all other ranges

**Line regulation:** Less than 0.01% change in output for 5% change in the DC input voltage

**Load regulation:** Less than 0.01% change in output current over the full range scale

**Stability (24 h):**  $\pm 0.05\%$  on 100 nA range,  $\pm 0.01\%$  per day on all other fixed ranges

**Connections:** Detachable terminal block

**Maximum load:** 300 k $\Omega$

**Maximum lead length:** 50 ft

## User setting

### Programming

Operation:	Output current settable via computer interface
Resolution:	3 significant digits
Accuracy:	$\pm 0.5\%$ of 100 nA and 300 nA ranges, $\pm 0.25\%$ of all other ranges
Maximum current:	100 mA
Minimum current:	100 nA

### Front panel

Display:	LED – 3 digits plus sign
Display units:	mA, $\mu$ A, and nA
Display update rate:	2 rdg/s
Display annunciators:	mA, $\mu$ A, nA, and compliance
Keypad:	4 full travel keys
Keypad functions:	Range Up, Range Down, Current Polarity, Output Inhibit

### Interface

USB	
Function:	Emulates a RS-232 serial port
Baud rate:	57,600
Connector:	B-type USB connector
Reading rate:	To 10 rdg/s
Software support:	LabVIEW™ driver (see <a href="http://www.lakeshore.com">www.lakeshore.com</a> )

## General

**Ambient temperature:** 15  $^{\circ}$ C to 35  $^{\circ}$ C at rated accuracy; 5  $^{\circ}$ C to 40  $^{\circ}$ C at reduced accuracy

**Power requirement:** +5 VDC  $\pm 5\%$  at 400 mA, barrel plug 5.5 mm OD  $\times$  2.1 mm ID  $\times$  9.9 mm L, center pin positive

**Size:** 96 mm W  $\times$  48 mm H  $\times$  166 mm D  
(3.8 in  $\times$  1.9 in  $\times$  6.5 in)

**Mounting:** Panel mount into 91 mm W  $\times$  44 mm H  
(3.6 in  $\times$  1.7 in) cutout

**Weight:** 0.45 kg (1 lb)

**Approval:** CE mark



**2111** Single 1/4 DIN panel-mount adapter,  
105 mm W  $\times$  132 mm H (4.1 in  $\times$  5.2 in)



**2112** Dual 1/4 DIN panel-mount adapter,  
105 mm W  $\times$  132 mm H (4.1 in  $\times$  5.2 in)

### Power supply (109-132)

#### Comes standard with interchangeable input plugs

**Power requirements** 100 to 240 VAC, 50 or 60 Hz, 0.3 A max

**Output** +5 V at 1.2 A

**Size** 40.5 mm W  $\times$  30 mm H  $\times$  64 mm D (1.6 in  $\times$  1.2 in  $\times$  2.5 in)

**Weight** 0.15 kg (0.33 lb)

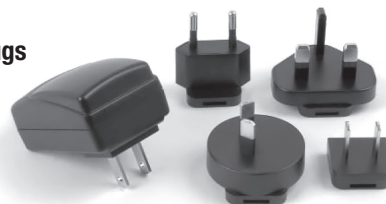

## Ordering information

Part number	Description
<b>121</b>	Programmable current source—includes one 100 V to 240 V, 10 W power supply with universal input interchangeable input plugs (109-132), calibration certificate, and user manual
<b>121N</b>	Programmable current source—no power supply. Includes calibration certificate and user manual
<b>2111</b>	Single 1/4 DIN panel-mount adapter
<b>2112</b>	Dual 1/4 DIN panel-mount adapter

### Accessories

<b>CAL-102-CERT</b>	Model 121 recalibration with certificate
---------------------	--

All specifications are subject to change without notice







# Accessories

- 135 Cryogenic Accessories
- 137 Wire
- 141 Cable
- 144 Solder
- 147 Epoxy
- 148 Grease
- 149 Varnish
- 150 Miscellaneous Accessories





## Cryogenic Accessories

Lake Shore offers a complete line of accessories for sensor installation and general-purpose cryogenic use.

### Cryogenic wire

Used to minimize heat leak into the sensor and cryogenic system, cryogenic wire has a much lower thermal conductivity (and higher electrical resistivity) than copper wire.

The most common type of cryogenic wire is phosphor bronze. This wire is available in one-, two-, and four-lead configurations. Four-lead configurations are available as Quad-twist™ (two twisted pairs) or Quad-lead™ (ribbon). Wire gauge is 32 or 36 AWG, with polyimide or polyvinyl formal (Formvar®) used to insulate the wires.

Other common cryogenic wires and coaxial cables include manganin, nichrome heater wire, and HD-30 heavy-duty copper wire. For high-frequency signals, Lake Shore provides various coaxial cables: ultra miniature coaxial cables and semi-rigid coaxial with a stainless steel center conductor.

### Solders

The most common electrical connections are solder joints. Solder can also be used to install various sensors to improve thermal heat sinking. Common solders are indium solder and 90/10 Pb/Sn. Indium solder is used for various applications including sensor installation to provide excellent thermal contact with the sample. 90/10 Pb/Sn solder is used for applications requiring a higher temperature (liquidus point of 575 K and solidus point 458 K). Ostalloy® 158 solder is used as a seal for demountable vacuum cans and electric feedthroughs in cryogenic systems.

### Varnish, thermal grease, and epoxy

Thermal greases and epoxies are used to install and fasten sensors, while providing thermal contact and/or electrical insulation, with the sample. Epoxy can be used for mechanical attachment and joints.

The most common varnish for cryogenic installations is VGE-7031 varnish. It has good chemical resistance, bonds to a variety of materials, and has a fast tack time. Stycast® 2850FT is composed of a black epoxy resin, and has a thermal expansion coefficient that is matched to copper. A silver-filled, low-temperature conducting epoxy provides excellent strength, along with electrical and thermal conductivity.

Thermal grease, Apiezon N and Apiezon H, is suitable for enhancing thermal contact, especially for sensors inserted into cavities. Apiezon N is for low temperature applications, while H is for high temperature.

### Miscellaneous

Lake Shore also supplies heat sink bobbins, a beryllium oxide heat sink chip, and a four-lead resistance sample holder. Cartridge heaters and vacuum feed through products are also available.



# Wire

## Abbreviations used in this section

American wire gauge	AWG
Single lead wire	SL
Duo-Twist™ wire	DT
Quad-Twist™ wire	QT
Quad-Lead™ wire	QL



## Specifications

		Phosphor bronze	Copper	Nichrome	Manganin
Melting range		1223 K to 1323 K	1356 K	1673 K	1293 K
Coefficient of thermal expansion		$1.78 \times 10^{-5}$	$20 \times 10^{-6}$	—	$19 \times 10^{-6}$
Chemical composition (nominal)		94.8% copper, 5% tin, 0.2% phosphorus	—	80% nickel, 20% chromium	83% copper, 13% manganese, 4% nickel
Electrical resistivity (at 293 K)		11 $\mu\Omega$ -cm	1.7 $\mu\Omega$ -cm	120 $\mu\Omega$ -cm	48 $\mu\Omega$ -cm
Thermal conductivity (W/(m-K))	0.1 K	NA	9	NA	0.006
	0.4 K	NA	30	NA	0.02
	1 K	0.22	70	NA	0.06
	4 K	1.6	300	0.25	0.5
	10 K	4.6	700	0.7	2
	20 K	10	1100	2.6	3.3
	80 K	25	600	8	13
	150 K	34	410	9.5	16
	300 K	48	400	12	22

	AWG	Resistance ( $\Omega$ /m)			Diameter (mm)	Fuse current air (A)	Fuse current vacuum (A)	Number of leads	Name	Insulated diameter (mm)	Insulation type	Insulation thermal rating (K)	Insulation breakdown voltage (VDC)
		4.2 K	77 K	305 K									
Phosphor bronze	32	3.34	3.45	4.02	0.203	4.2	3.1	1	SL-32	0.241	Polyimide	493	400
								2	DT-32	0.241	Polyimide		
								4	QT-32	0.241	Polyimide		
									QL-32	0.241	Polyimide		
	36	8.56	8.83	10.3	0.127	2.6	1.4	1	SL-36	0.152	Formvar®	368	250
								2	DT-36	0.152	Polyimide	493	400
								4	QT-36	0.152	Formvar®	368	250
									QL-36	0.152	Polyimide	493	400
Nichrome	32	33.2	33.4	34	0.203	2.5	1.8	1	NC-32	0.241	Polyimide	493	400
Copper	30	0.003	0.04	0.32	0.254	10.2	8.8	1	HD-30	0.635	Teflon®	473	250
	34	0.0076	0.101	0.81	0.160	5.1	4.4	2	CT-34	0.254	Teflon®	473	100
Manganin	30	8.64	9.13	9.69	0.254	4.6	4.3	1	MW-30	0.295	Heavy Formvar®	378	400
	32	13.5	14.3	15.1	0.203	3.8	3.5	1	MW-32	0.241	Heavy Formvar®		400
	36	34.6	36.5	38.8	0.127	2.6	2.5	1	MW-36	0.152	Heavy Formvar®		250



## Phosphor bronze wire

Phosphor bronze wires are suitable for almost all cryogenic applications. The low magneto-resistance of these wires make them the ideal choice for magnetic field use.

### Physical properties

**Melting range:** 1223 K to 1323 K (950 °C to 1050 °C)

**Coefficient of thermal expansion:**  $1.78 \times 10^{-5}$

**Thermal conductivity:** 48 W/(m · K) at 293 K

**Electrical resistivity (annealed):**  $1.15 \times 10^{-7} \Omega \cdot \text{m}$  at 293 K

**Specific heat:** 376.4 J/(kg · K)

**Stress relief temperature (1 h):** 423 K to 498 K (150 °C to 225 °C)

**Chemical composition:** Nominal 94.8% copper, 5% tin, 0.2% phosphorus

### Single-strand cryogenic wire—WSL-32, WSL-36

- Phosphor bronze wire
- Non-ferromagnetic
- Single strand
- 32 and 36 AWG
- Polyimide insulation (WSL-32)
- Formvar® insulation, clear (WSL-36)

Lake Shore non-magnetic single-lead wire is a phosphor bronze (CuSnP alloy) wire. This wire has a relatively low temperature dependence of its resistance from room temperature to helium temperatures. WSL-32 can be used for sensor installations requiring stronger and more 'rugged' leads. WSL-36 wire is recommended for general sensor installation.

### Ordering information

Part number	Description
WSL-32-100	32 AWG, 30 m (100 ft)
WSL-32-250	32 AWG, 76 m (250 ft)
WSL-36-500	36 AWG, 152 m (500 ft)



### Insulation

#### Polyvinyl formal (Formvar®)

Magnet wire is insulated with vinyl acetal resin, as a smooth uniform film. Formvar® has excellent mechanical properties such as abrasion resistance and flexibility. The film will stand excessive elongation without rupture. When stressed during winding, Formvar® has a tendency to craze upon contact with solvents such as toluol, naphtha, and xylol, therefore, it should be given an annealing preheat prior to varnish application. Formvar® can be removed mechanically during terminal preparation. Formvar® is rated to 3525 VAC for 32 AWG, 2525 VAC for 36 AWG.

#### Polyimide (ML)

ML is a film coated insulation made with polyimide resin. It is a Class 220 thermal life insulation with exceptional resistance to chemical solvents and burnout. It will operate at temperatures in excess of 493 K (220 °C) for intermittent duty. ML is unaffected by prolonged exposure to varnish solvents and is compatible with virtually all systems. Polyimide insulation is rated to 3525 VAC for 32 AWG, 2525 VAC for 36 AWG.

*Note: At Lake Shore, we strip both Formvar® and polyimide mechanically using an Eraser Rush Model RT-2 mechanical stripper.*





### Duo-Twist™ cryogenic wire—WDT-32, WDT-36

- Phosphor bronze wire
- Non-ferromagnetic
- Single twisted pair (2 wires)
- Color-coded leads
- Minimizes pickup noise
- 32 and 36 AWG
- Polyimide insulation

Duo-Twist™ is a single twisted pair (2 leads) of 32 or 36 AWG phosphor bronze wire twisted at 3.15 twists per centimeter (8 twists per inch). This wire is a good choice when any possibility of pickup noise to a diode sensor or sample by induced currents through the leads needs to be minimized.

### Ordering information

Part number	Description
WDT-32-25	32 AWG, 7.6 m (25 ft)
WDT-32-100	32 AWG, 30 m (100 ft)
WDT-32-500	32 AWG, 152 m (500 ft)
WDT-36-25	36 AWG, 7.6 m (25 ft)
WDT-36-100	36 AWG, 30 m (100 ft)
WDT-36-500	36 AWG, 152 m (500 ft)



### Quad-Twist™ cryogenic wire—WQT-32, WQT-36

- Phosphor bronze wire
- Non-ferromagnetic
- 2 twisted pairs (4 wires), color coded
- Minimizes pickup noise
- Polyimide insulation (WQT-32)
- Formvar® insulation (WQT-36)

Quad-Twist™ is 2 twisted pairs (4 leads) of 32 or 36 AWG phosphor bronze wire. Each pair incorporates 3.15 twists per centimeter (8 twists per inch), and the 2 pairs are entwined at 1.57 twists per centimeter (4 twists per inch). This wire is a good choice when pickup noise to a diode sensor or sample by induced currents through the leads needs to be minimized. Use one twisted pair for sensor excitation and the other twisted pair for sensor output voltage to minimize pickup of electromagnetic noise.

### Ordering information

Part number	Description
WQT-32-25	32 AWG, 7.6 m (25 ft)
WQT-32-100	32 AWG, 30 m (100 ft)
WQT-32-500	32 AWG, 152 m (500 ft)
WQT-36-25	36 AWG, 7.6 m (25 ft)
WQT-36-100	36 AWG, 30 m (100 ft)
WQT-36-500	36 AWG, 152 m (500 ft)



### Quad-Lead™ cryogenic wire—WQL-32, WQL-36

- Phosphor bronze wire
- Non-ferromagnetic
- Four color-coded leads
- 32 and 36 AWG
- Polyimide insulation

The Quad-Lead™ wire is a 4-wire “ribbon cable”, which makes heat sinking and dressing leads much easier than working with individual wires. Noninductive (bifilar) windings are simple to make for heat sinks and heaters using the Quad-Lead™ wire. In addition, the wire is color coded for easy lead identification, and can be split to yield 2 wire pairs. Quad-Lead™ wire is also useful in standard 4-lead measurements in magnetic field applications due to its low magnetoresistance.

**Note:** Squad-Lead™ wires are formed into a “ribbon cable” using Bond Coat 999 bonding film. Wire separation can be accomplished mechanically through the use of a razor blade or other tool equipped with a sharp, flat blade.

### Ordering information

Part number	Description
WQL-32-25	32 AWG, 7.6 m (25 ft)
WQL-32-100	32 AWG, 30 m (100 ft)
WQL-32-500	32 AWG, 152 m (500 ft)
WQL-36-25	36 AWG, 7.6 m (25 ft)
WQL-36-100	36 AWG, 30 m (100 ft)
WQL-36-500	36 AWG, 152 m (500 ft)





### Nichrome heater wire—WNC-32

- Nominal 80% nickel, 20% chromium
- Non-ferromagnetic
- 32 AWG
- Polyimide insulation

This high-resistance wire is typically used for heater requirements. The relatively large wire size provides sufficient surface area to dissipate the heat generated within the wire with only a moderate rise in wire temperature

Note: We have had poor experience with heaters made using wire smaller than 32 AWG and supplying 25 W or more power. A possible alternative is one of the Lake Shore cartridge heaters, see page 152.

### Ordering information

Part number	Description
WNC-32-100	32 AWG, 30 m (100 ft)
WNC-32-250	32 AWG, 76 m (250 ft)



### Twisted lead wire—WCT-34

- Silver-plated copper, 34 AWG
- Teflon® insulation

These low-resistance twisted pair wires are ideal for extending the lead length of Lake Shore cryogenic Hall sensors.

### Ordering information

Part number	Description
WCT-YB-34-25	Yellow/blue, 7.6 m (25 ft)
WCT-YB-34-50	Yellow/blue, 15 m (50 ft)
WCT-YB-34-100	Yellow/blue, 30 m (100 ft)
WCT-RB-34-25	Red/black, 7.6 m (25 ft)
WCT-RB-34-50	Red/black, 15 m (50 ft)
WCT-RB-34-100	Red/black, 30 m (100 ft)



### Heavy duty lead wire—WHD-30

- 30 AWG
- Seven 38 AWG silver-plated twisted copper strands
- Black etched Teflon® for adhesion to epoxy

This more rugged wire is useful as a lead wire to resistance heaters in cryogenic environments where low resistance to the heater is required or desired.

### Ordering information

Part number	Description
WHD-30-100	30 AWG, 30 m (100 ft)



### Manganin wire—WMW-30, WMW-32, WMW-36

- Nominal 83% copper, 13% manganese, and 4% nickel
- Non-ferromagnetic
- 30, 32, and 36 AWG
- Heavy Formvar® insulation

Lake Shore manganin wire is often used for cryostat wiring or heater requirements in nonmagnetic applications.

### Ordering information

Part number	Description
WMW-30-100	30 AWG, 30 m (100 ft)
WMW-30-500	30 AWG, 152 m (500 ft)
WMW-32-100	32 AWG, 30 m (100 ft)
WMW-32-500	32 AWG, 152 m (500 ft)
WMW-36-100	36 AWG, 30 m (100 ft)
WMW-36-500	36 AWG, 152 m (500 ft)





# Coaxial Cable

## Specifications

	Type SC	Type SS	Type SR
<b>Dimensions</b>			
Center conductor—AWG (diameter)	32 (0.2032 mm [0.008 in])	32 (0.2032 mm [0.008 in])	37 (0.1143 mm [0.004 in])
Dielectric/insulating material (diameter)	0.406 mm (0.016 in)	0.406 mm (0.016 in)	0.38 mm (0.015 in)
Shield (diameter)	0.711 mm (0.028 in)	0.711 mm (0.028 in)	0.51 mm (0.02 in)
Drain wire (parallel to conductor)	NA	NA	NA
Jacket outer dimension	1.0 mm (0.04 in)	1.0 mm (0.04 in)	0.51 mm (0.02 in)
<b>Material</b>			
Center conductor	Stranded copper <sup>1</sup>	304 stainless steel <sup>2</sup>	Carbon steel <sup>3</sup>
Dielectric/insulating material	Teflon® FEP	Teflon® FEP	Teflon® PTFE
Shield	Braided gold-plated copper <sup>4</sup>	304 braided stainless <sup>5</sup>	304 stainless steel <sup>6</sup>
Drain wire	NA	NA	NA
Jacket material	Teflon® FEP	Teflon® FEP	NA
Jacket color	Gold	Gray	NA
<b>Electrical properties</b>			
Resistance $\Omega$ /m ( $\Omega$ /ft)			
Center conductor at 293 K (20 °C)	0.282 (0.086)	23.62 (7.2)	4.30 (1.31)
Shield at 296 K (23 °C)	0.085 (0.026)	3.61 (1.1)	8.63 (2.63)
Drain wire at 296 K (23 °C)	NA	NA	NA
Center conductor maximum DC voltage	600 V	600 V	700 V
Center conductor maximum DC current	200 mA	200 mA	200 mA
Temperature range	<1 K to 400 K	10 mK to 473 K	10 mK to 400 K
Characteristic impedance	35 $\Omega$ at 10 MHz	40 $\Omega$ at 10 MHz	50 $\Omega$ ( $\pm 2 \Omega$ )
Nominal capacitance at 5 kHz	154.2 pF/m (47 pF/ft)	173.9 pF/m (53 pF/ft)	95.14 pF/m (29 pF/ft)

<sup>1</sup> 65 strands of 50 AWG

<sup>2</sup> 64 strands of 50 AWG 304 SS wire

<sup>3</sup> Silver-plated copper-clad carbon steel (0.103 mm outer diameter carbon steel covered by 0.0057 mm thick copper cladding covered by 0.001 mm thick silver plating)

<sup>4</sup> 12  $\times$  3 matrix of 42 AWG wire

<sup>5</sup> 12  $\times$  4 matrix of 44 AWG wire

<sup>6</sup> A seamless tubular metal jacket serves as the outer conductor/shield



## Ultra miniature coaxial cable – Type SC and SS

- Very flexible
- Long flex life
- Available in two configurations:
  - SC** – stranded copper conductors
  - SS** – stranded 304 stainless steel conductors

Ultra miniature coaxial cable is for use when a strong and flexible cable is needed. Type SC is recommended when low conductor resistance is a prime consideration. Type SC and type SS are mechanically the most flexible, due to their braided construction. Type SS is recommended for use when both shielding and low thermal losses are important.

For technical specifications on types SS, C, SC and SR, see page 141.

### Thermal conductivity of copper—units are W/(m·K)

	4 K	20 K	30 K	77 K	300 K
RRR <sup>8</sup> = 20	122	719	870	502	397
RRR = 100	460	2460	2070	533	407

<sup>8</sup> RRR = residual resistance ratio

$$\frac{R_{273K}}{R_{4.2K}} = RRR$$

	Nominal attenuation (dB/m)	
	SC	SS
1 MHz	0.108	0.569
5 MHz	0.240	1.272
10 MHz	0.344	1.799
15 MHz	0.421	2.850
20 MHz	0.486	2.545
50 MHz	0.769	4.031
100 MHz	1.090	5.694
500 MHz	2.453	12.749
1 GHz	3.488	18.048
2 GHz	—	—
5 GHz	7.968	40.526

### Ordering information

Part number	Description
CC-SC-25	Stranded copper, 7.6 m (25 ft)
CC-SC-50	Stranded copper, 15 m (50 ft)
CC-SC-100	Stranded copper, 30 m (100 ft)
CC-SC-500	Stranded copper, 152 m (500 ft)
CC-SS-25	Stranded stainless, 7.6 m (25 ft)
CC-SS-50	Stranded stainless, 15 m (50 ft)
CC-SS-100	Stranded stainless, 30 m (100 ft)
CC-SS-500	Stranded stainless, 152 m (500 ft)

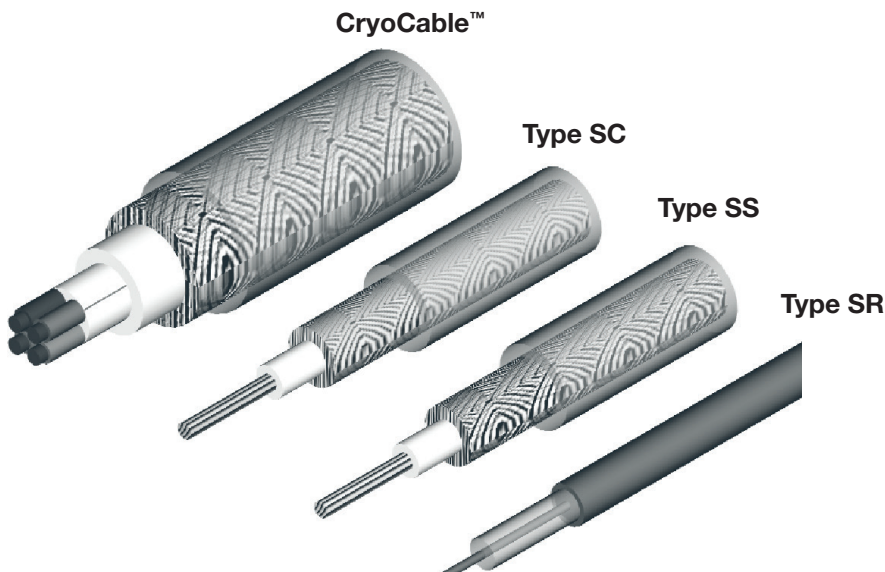



## Semi-rigid coaxial cable—type SR

- Easily bent, coiled, stripped, machined, soldered, or connected without impairing performance
- Solid center conductor provides the optimum geometrical surface for transmission
- Low standing wave ratio (SWR) with a dielectric controlled to exacting tolerances
- Low thermal conductivity ( $\approx 0.4 \text{ W/(m}\cdot\text{K)}$  at  $4.2 \text{ K}$ )<sup>9</sup>
- Matching minimizes reflective power loss
- Provides shielding isolation for virtually no extraneous signal pickup
- Tubular outer conductor offers minimum size and maximum conductor integrity; stainless steel jacket can be soldered directly to circuit boards
- 37 AWG, silver-plated copper-weld steel center conductor

<sup>9</sup> Thermal conductivity at low temperatures is dominated by the copper cladding around the center conductor

This cable transmits and receives high-speed, high-frequency microwave signals. Typically used for transmission lines in cryogenic-vacuum test systems.

### To remove the outer conductor:

1. Score jacket
2. Bend at score until shield kinks, fatigues, and breaks
3. Slide off outer conductor

Extreme caution must be used in this process to avoid damage to the cable

## CryoCable™—type CYRC

- **Robust:** the NbTi wire cores are strong and fatigue resistant, and the cable overbraid of 304 stainless steel adds significant strength and crush resistance
- **Low heat leak** due to all metal alloy and Teflon® construction
- **Solderable:** the CuNi wire surface is easy to solder with conventional rosin fluxes
- **Cryo-compatible:** all Teflon® (PFA) insulation is heat strippable for ease of preparation

A robust, 4-wire cable for use in cryogenic environments to room temperature is now available. The cable is designed around 32 AWG (203  $\mu\text{m}$ ) diameter superconductive wires consisting of a NbTi core (128  $\mu\text{m}$  diameter) and a Cu-10% Ni jacket.

Minimum bend radius: 15 mm (0.6 in)  
Critical temperature: 9.8 K  
Critical field: 10 T

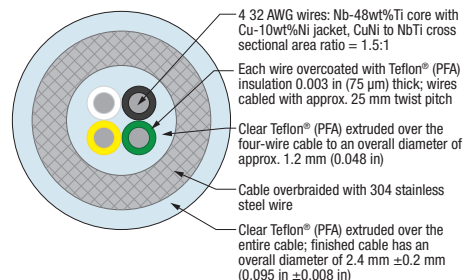

SR coaxial cable frequency response specifications		
	Insertion loss dB/m (dB/ft)	Power CW (20 °C, sea level, W)
0.5 GHz	4.43 (1.35)	7.6
1.0 GHz	6.27 (1.91)	5.3
5.0 GHz	14.09 (4.30)	2.4
10.0 GHz	20.01 (6.10)	1.7
20.0 GHz	28.45 (8.67)	1.2

### Ordering information

Part number	Description
CC-SR-10	Semi-rigid, 3 m (10 ft)



	Temperature (K)		
	295	77	4.2
Wire resistance — per wire ( $\Omega/\text{m}$ )	9.2	8.4	0 <sup>10</sup>
Overbraid resistance ( $\Omega/\text{m}$ )	0.90	0.64	0.62
Thermal conductivity — entire cable assembly ( $\Omega/\text{m}\cdot\text{K}$ )	7.6	2.8	0.17

<sup>10</sup> Superconducting

Field	Critical current (per wire)
3 T	35 A
5 T	25 A
7 T	15 A
9 T	6 A

### Ordering information

Part number	Description
CRYC-32-25	CryoCable™, 7.6 m (25 ft)
CRYC-32-50	CryoCable™, 15 m (50 ft)
CRYC-32-100	CryoCable™, 30 m (100 ft)





## Solder

	Indium foil	High temperature solder	Ostalloy®
<b>Melting point</b>	430 K	Solidus 548 K Liquidus 575 K	343.16 K
<b>Electrical thermal conductivity</b>	84 W/(m·K) at 293 K	35 W/(m·K) at 293 K	18.6 W/(m·K) at 293 K
<b>Resistivity</b>	$9 \times 10^{-4} \Omega\text{-m}$ at 293 K	$204 \times 10^{-9} \Omega\text{-m}$ at 293 K	—
<b>Tensile strength</b>	2.61 MPa to 3.55 MPa	30 MPa	—
<b>Density</b>	7.3 g/cm <sup>3</sup>	10.75 g/cm <sup>3</sup>	9.67 g/cm <sup>3</sup>
<b>Composition</b>	99.99% pure Indium	90% Pb 10% Sn	49.5% Bi, 27.3% Pb, 13.1% Sn, 10.1% Cd

### Indium foil/solder

- Foil form
- Exceptional pressure seal
- Extremely malleable
- 99.99% pure
- Acts as a metallic seal against corrosion
- Flexible sensor mounting material for low stress at cryogenic temperatures

Indium can be used to create solder “bumps” for microelectronic chip attachments and also as gaskets for pressure and vacuum sealing purposes. When used as a washer between a silicon diode or other temperature sensors and refrigerator cold stages, indium foil increases the thermal contact area and prevents the sensor from detaching due to vibration. It also may be used as a sealing gasket for covers, flanges and windows in cryogenic applications.

Indium, a semiprecious, nonferrous metal, is softer than lead, and extremely malleable and ductile. It stays soft and workable down to cryogenic temperatures. It is an excellent choice for cryogenic pumps, high vacuum systems and other unique joining and sealing applications. Indium lends itself to this application due to its characteristic “stickiness” or “tackiness” and ability to conform to many irregular surfaces.

*Note: Indium foil becomes a superconductor at 3.38 K (-270 °C), below which the thermal conductivity decreases.*

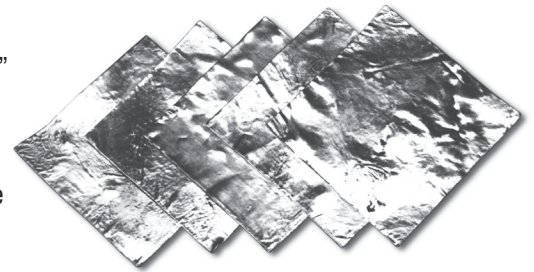

### Specifications

**Melting point:** 430 K (157 °C)

**Thermal conductivity at 293 K (20 °C):** 84 W/(m · K)

**Superconducting transition:** 3.38 K (-270 °C)

**Volume resistivity (Ω·m):**  $8.27 \times 10^{-4}$  at 273 K (0 °C);  
 $9.00 \times 10^{-4}$  at 293 K (20 °C);  $30.11 \times 10^{-4}$  at 455 K (182 °C)

**Thermal expansion coefficient:**  $24.8 \times 10^{-6}$  at 300 K (27 °C)

**Magnetism:** Diamagnetic

**Dimensions:** 0.127 mm × 50.8 mm × 50.8 mm (0.005 in × 2 in × 2 in)

**Tensile strength:** 2.61 MPa to 3.55 MPa (380 psi to 515 psi)

**Specific heat:** 290 J/(kg · K) at 293 K

### Ordering information

Part number	Description
IF-5	5 indium foil sheets, 0.127 mm × 50.8 mm × 50.8 mm (0.005 in × 2 in × 2 in)
ID-10-31	10 indium disks, 7.925 mm diameter × 0.127 mm (0.312 in diameter × 0.005 in)
ID-10-56	10 indium disks, 14.27 mm diameter × 0.127 mm (0.562 in diameter × 0.005 in)





## High temperature solder

- 90% Pb, 10% Sn
- Good for connecting hardware
- Solidifies quickly

This solder has a higher lead content than normal electronics solder, and can be used for connecting hardware for use at cryogenic temperatures. Its higher melting point also makes it perfect for soldering leads to silicon diode, platinum, or rhodium-iron temperature sensors for operation up to 500 K (227 °C).

### Specifications

**Solidus:** 548 K (275 °C)  
**Liquidus:** 575 K (302 °C)  
**Density:** 10.75 g · cm<sup>-3</sup>  
**Diameter:** 0.787 mm (0.031 in)

### Ordering information

Part number	Description
SLT-10	90% Pb, 10% Sn solder, 3 m (10 ft)



## Ostalloy® 158 solder

- Does not shrink, but exhibits expansion upon solidification
- Low melting temperature 343 K (70 °C), requiring only a simple melting pot and a gas or electric heat source
- Reusable many times
- Oxide separated easily in hot water
- Solidifies quickly
- Creates almost no dross because of its low melting temperature

This is a low melting point solder, nearly identical to what is commonly called Wood's Metal. An alloy of bismuth, tin, lead, and cadmium, it is an eutectic alloy with a sharply defined melting point of 343.16 K (70 °C). Ostalloy® 158 has proven itself in production processes—there is no equal to be found to its special advantages.

Mainly used as sealing for demountable vacuum cans and electric feedthroughs in cryogenic testing facilities. Good for soldering any items which cannot be subjected to high temperatures. Ostalloy® 158 solder is used for tool fixturing, holding small parts to be machined, tube shaping and bending, nesting fixturing dies, and internal and external support of thin walled tools and parts. This solder is not recommended for general temperature sensor lead attachment due to its low joint strength.



### Specifications

**Composition of Ostalloy® 158 solder:**  
 49.5% Bi, 27.3% Pb, 13.1% Sn, 10.1% Cd

### Ordering information

Part number	Description
SOSY-16	Ostalloy® 158 solder, 454 g (16 oz)





# Epoxy, Grease, and Varnish

## Specifications

	Conductive epoxy	Stycast® epoxy	Apiezon grease		Varnish
			Type N	Type H	
Maximum temperature	573 K	403 K	303 K	513 K	423 K
Glass transition temperature	≥353 K	359 K	—	—	—
Thermal conductivity					
1 K	—	0.0065 W/(m · K)	0.001 W/(m · K)	—	0.034 W/(m · K)
4.2 K	—	0.064 W/(m · K)	0.005 W/(m · K)	—	0.062 W/(m · K)
77 K	—	—	—	—	0.22 W/(m · K)
100 K	—	—	0.11 W/(m · K)	—	0.24 W/(m · K)
300 K	2.5 W/(m · K)	1.3 W/(m · K)	0.19 W/(m · K)	0.22 W/(m · K)	0.44 W/(m · K)
Thermal expansion (1/K)	>360 K: $150 \times 10^{-6}$ <360 K: $43 \times 10^{-6}$	$29 \times 10^{-6}$	0.00072	0.00072	—
Volume resistivity	At 298 K: 0.0001 to 0.0004 (Ω-cm)	298 K: $5 \times 10^{14}$ (Ω-m) 394 K: $1 \times 10^{10}$ (Ω-m)	$2 \times 10^{16}$ (Ω-m)	$4.6 \times 10^{13}$ (Ω-m)	$>1 \times 10^{15}$ (Ω-m)
Shelf-life (298 K max)	12 months from date of manufacture	12 months from date of manufacture	—	—	12 months from date on the can when stored at room temperature
Pot life	4 days, ~1 day working time	45 min, ~20 min working time	—	—	—
Cure schedule	323 K: 12 h 353 K: 90 min 393 K: 15 min 423 K: 5 min 448 K: 45 s	298 K: 16 to 24 h 318 K: 4 to 6 h 338 K: 1 to 2 h	NA	NA	5 min to 10 min drying time
Dielectric strength	NA (conductive)	14.4 kV/mm	—	—	(Dry) 118 kV/mm
Dielectric constant	NA (conductive)	(1 MHz): 5.01	—	—	—
Vapor pressure	—	<13.3 Pa (0.1 Torr) at 298 K	$2.27 \times 10^{-7}$ Pa ( $1.7 \times 10^{-9}$ Torr) at 293 K	$2.27 \times 10^{-7}$ Pa ( $1.7 \times 10^{-9}$ Torr) at 293 K	Partial
Outgassing	—	TML: 0.25% CVCM: 0.1%	TML: <1% CVCM: <0.1%	TML: <1% CVCM: <0.1%	—





# Epoxy

## Low temperature conductive epoxy

- Excellent low temperature thermal and electrical conductivity
- Low viscosity
- Thixotropic
- No resin bleed during curing
- Low weight loss
- Low volatility

This epoxy is used to permanently attach test samples or temperature sensors to sample holders. It is a 100% solid, two component, low temperature curing, silver-filled epoxy which features very high electrical and thermal conductivity combined with excellent strength and adhesive properties.

*Note: Epoxy must be cured at a minimum of 50 °C for 12 h to achieve proper electrical and physical properties. Curing at 175 °C for 45 s will achieve optimum properties.*

**ESF-2-5 and ESF-2-10 can be used to 300 mK and below. Results may vary based on application and materials used.**

### Specifications

**Maximum operating temperature:** 573 K (300 °C)  
**Thermal conductivity:** 300 K (27 °C)—2.5 W/(m · K)  
**Thermal expansion coefficient (K<sup>-1</sup>):** Above 360 K (85 °C)— $150 \times 10^{-6}$ ; below 360 K (85 °C)— $43 \times 10^{-6}$   
**Volume resistivity (Ω-cm) at 298 K (25 °C):** 0.0001 to 0.0004  
**Shelf life (25 °C [298 K] max):** 12 months from date of manufacture  
**Pot life:** 4 days, about 1 day working time  
**Cure schedule:** 323 K (50 °C)—12 h; 353 K (80 °C)—90 min; 393 K (120 °C)—15 min; 423 K (150 °C)—5 min; 448 K (175 °C)—45 s

### Ordering information

Part number	Description
ESF-2-5	Low temperature conductive epoxy, 5 packets, 2 g each
ESF-2-10	Low temperature conductive epoxy, 10 packets, 2 g each



## Stycast® epoxy 2850-FT, catalyst 9

- Mixed and applied from two-part flexible packets
- Excellent low temperature properties
- Permanent mounting
- Exceptional electrical grade insulation properties
- Low cure shrinkage
- Low thermal expansion
- Resistance to chemicals and solvents

Stycast® is the most commonly used, highly versatile, nonconductive epoxy resin system for cryogenic use. The primary use for Stycast® is for vacuum feedthroughs or permanent thermal anchors. Lake Shore uses this product in vacuum tight lead-throughs with excellent thermal cycle reliability. Stycast® is an alternative to Apiezon® N grease when permanent sensor mounting is desired. (Can place stress on sensor—see Appendix C.)

*Note: Can be chemically removed with methylene-chloride (several hour soak). A commercial stripper is available from Miller-Stephenson Co. (<http://www.miller-stephenson.com/>) part number MS-111.*

**Shipped as a Dangerous Good.**

### Specifications

**Maximum operating temperature:** 403 K (130 °C)  
**Glass transition temperature:** 359 K (86 °C)  
**Thermal conductivity:**  
 1 K (272 °C)—0.0065 W/(m · K)  
 4.2 K (269 °C)—0.064 W/(m · K)  
 300 K (27 °C)—1.3 W/(m · K)  
**Thermal expansion coefficient (1/K):**  $29 \times 10^{-6}$   
**Volume resistivity [Ω-m]**  
 298 K (25 °C)— $5 \times 10^{14}$   
 394 K (121 °C)— $1 \times 10^{10}$   
**Shelf life (25 °C [298 K] max):** 12 months from date of manufacture  
**Pot life:** 45 minutes, about 20 minutes working time  
**Cure schedule:** 298 K (25 °C)—16 h to 24 h  
 318 K (45 °C)—4 h to 6 h  
 338 K (65 °C)—1 h to 2 h  
**Dielectric strength:** 14.4 kV/mm  
**Dielectric constant (1 MHz):** 5.01  
**Vapor pressure at 298 K (25 °C):** <13.3 Pa (0.1 Torr)  
**Outgassing** TML: 0.25% CVCVM: 0.01%

### Ordering information

Part number	Description
ES-2-20	Stycast® epoxy, 20 packets, 2 g each





## Grease

### Apiezon® grease—Types N and H

- Stable
- Nonpermanent sensor mounting
- Chemically inert
- Nontoxic
- Easily applied and removed
- Excellent lubrication properties

Apiezon® grease is well-suited for cryogenic use because of its low vapor pressure and high thermal conductivity. It is often used for nonpermanent mounting and thermal anchoring of cryogenic temperature sensors as well as for lubricating joints and o-rings.

Apiezon® N: this general purpose grease enhances thermal contact and provides a temporary mounting method for temperature sensors. It is pliable at room temperatures and solidifies at cryogenic temperatures, which makes it easy to apply and remove the sensor (without damage) at room temperature. The grease is not an adhesive and will not necessarily hold a sensor or wires in place without some mechanical aid, such as a spring clip or tape. It is very good for sensors inserted into holes. Contains a high molecular weight polymeric hydrocarbon additive which gives it a tenacious, rubbery consistency allowing the grease to form a cushion between mating surfaces.

Apiezon® H: this grease will withstand temperatures up to 523 K (250 °C) without melting. It is designed for general purposes where operating temperatures necessitate the use of a relatively high melting point grease.

**Note:** Can be removed using Xylene with an isopropyl alcohol rinse.



### Specifications

	Type N	Type H
<b>Approximate melting point:</b>	316 K (43 °C)	523 K (250 °C)
<b>Thermal conductivity:</b>		
<b>293 K (20 °C)</b>	0.19 W/(m-K)	0.22 W/(m-K)
<b>1 K (-272 °C)</b>	0.001 W/(m-K)	—
<b>4.2 K (-269 °C)</b>	0.005 W/(m-K)	—
<b>100 K (-173 °C)</b>	0.15 W/(m-K)	—
<b>300 K (27 °C)</b>	0.44 W/(m-K)	—
<b>Volume resistivity:</b>	$2 \times 10^{16} \Omega\text{-m}$	$4.6 \times 10^{13} \Omega\text{-m}$
<b>Thermal expansion coefficient (K<sup>-1</sup>):</b>	0.00072	
<b>Vapor pressure at 293 K (20 °C):</b>	$2.67 \times 10^{-7} \text{ Pa}$ ( $2 \times 10^{-9} \text{ Torr}$ )	$3.60 \times 10^{-7} \text{ Pa}$ ( $2.7 \times 10^{-9} \text{ Torr}$ )
<b>Solvent system:</b>	Hydrocarbons or chlorinated solvents	

### Ordering information

Part number	Description
GAN-25	Apiezon® N grease, 25 g tube
GAH-25	Apiezon® H grease, 25 g tube





# Varnish

## VGE-7031 varnish

- Clear modified phenolic
- Can be air-dried or baked
- Use up to 470 K for 1 to 2 hour maximum
- Varnish will not outgas after baking
- Can be used in vacuum ( $1.33 \times 10^{-6}$  Pa [ $9.98 \times 10^{-9}$  Torr])
- Superior electrical properties
- Excellent chemical resistance
- May be applied by dipping, roller coating, brushing, or spraying
- Moderately good, low stress adhesive
- Enhances thermal contact

VGE-7031 insulating varnish and adhesive possesses electrical and bonding properties which, when combined with its chemical resistance and good saturating properties, make it an excellent material for cryogenic temperatures. As an adhesive, VGE-7031 bonds a variety of materials, has fast tack time, and may be air-dried or baked. It is excellent for laminating many types of materials, and may be applied to parts to be bonded and either baked shortly after applying or allowed to air dry and baked after the parts are stored and assembled hours, days, or even **weeks** later. It is also an electrically insulating adhesive at cryogenic temperatures, and is often used as a calorimeter cement. VGE-7031 is compatible when dry with a wide variety of materials, including cotton, Dacron® polyester fiber, nylon glass tapes, laminates, Mylar® polyester film, mica products, polyester products, vinyl products, wire enamels, paints, rayon, plastics, and metals. When soaked into cigarette paper, it makes a good, high thermal conductivity, low electrical conductivity heat sinking layer.

*Note: May be thinned to the desired application viscosity with a 50:50 mix of denatured alcohol and toluene.*

*The solvents in the varnish have a tendency to craze Formvar® wire insulation. The wire cannot be disturbed during curing of the varnish (typically 12 to 24 hours at room temperature).*

**Classified as hazardous cargo by the U.S. Government. UPS Ground shipment only.**

**Available in continental U.S. only.**

### Specifications

**Maximum operating temperature:** 423 K (150 °C)

**Thermal conductivity:**

1 K (-272 °C)—0.034 W/(m·K)

4.2 K (-269 °C)—0.062 W/(m·K)

77 K (-196 °C)—0.22 W/(m·K)

100 K (-173 °C)—0.24 W/(m·K)

300 K (27 °C)—0.44 W/(m·K)

**Percent solids by weight:** 18 to 20%

**Viscosity at 298 K (25 °C):** 1.3 kg/(m·s) (1300 cP)

**Specific gravity at 298 K (25 °C):** 0.88

**Flash point, closed cup:** 269 K (-4 °C)

**Shelf life:** 12 months from date on the can when stored at room temperature

**Drying time (25 µm film, tack free):** 5 min to 10 min at

298 K (25 °C); 2 min to 5 min at 398 K (125 °C)

**Solvent system:** Xylene, alcohol, acetone

### Ordering information

**Part number**

VGE-7031

**Description**

Insulating varnish and adhesive, 0.47 L (1 pt) can





## Miscellaneous Accessories

### Heat sink bobbins

Heat sink bobbins for cryostat lead wires are gold-plated OFHC or ETP copper for removing heat flowing down sensor leads. The small bobbin holds 4 to 8 phosphor bronze or manganin wires, and the large bobbin holds up to 40, depending on wire gauge and number of wraps. 4 or 5 wraps are usually sufficient, using VGE-7031 varnish or Stycast® epoxy for potting the wires. Do not use copper or other high conductivity wires.

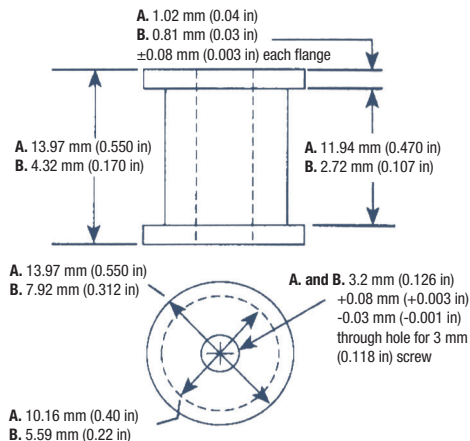

### Ordering information

Part number	Description
HSB-40	Large heat sink bobbin (use "A" dimensions)
HSB-8	Small heat sink bobbin (use "B" dimensions)



### Beryllium oxide heat sink chip

Beryllium oxide heat sink chips can be used to heat sink electrical leads or samples at low temperature with good electrical isolation. They can also be used as a buffer layer to take up expansion mismatch between an object with large expansion coefficient (e.g., copper, epoxy) and an object with a low expansion coefficient (e.g., a DT-670-SD diode sensor). One side is fully metallized with molybdenum/manganese, followed by nickel and gold. It is easily soldered with In/Ag solders. Sn/Pb solders can pull up metallization under some circumstances. The other side has two 1.27 mm (0.05 in) by 4.06 mm (0.16 in) electrically isolated solder pads. The thermal conductivity is several times that of copper in the liquid nitrogen region but about 1000 times lower at liquid helium temperature. The magnetic susceptibility is about that of non-magnetic stainless steel.

**Note:** Due to metallization irregularities and surface dirt, it is not recommended that these chips isolate more than 100 V.

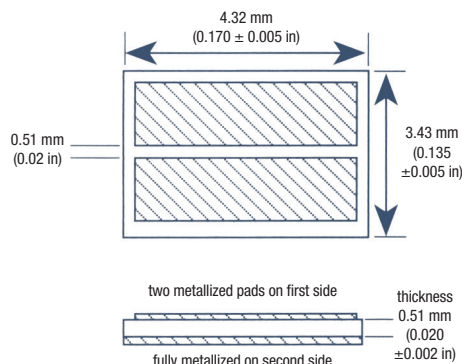

### Ordering information

Part number	Description
HSC-4	Heat sink chip (package of 10)





## 19-pin vacuum feedthrough

This hermetically sealed glass-to-metal electronic connector is designed to meet the dimensional requirements of MIL-C-26482 and is furnished with a silicone o-ring to seal against the mating connector plug shell. It is commonly used to pass electrical signals into a vacuum chamber from the outside.

**Note:** The VFT19-FMC threads should be sealed with Teflon® tape or epoxy if a vacuum seal is important.

VFT19

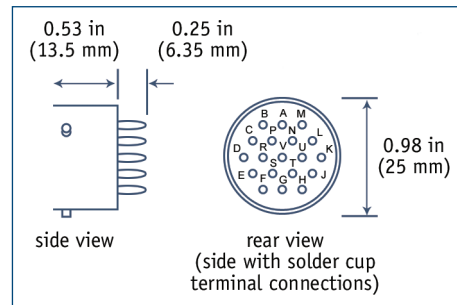

VFT19-F

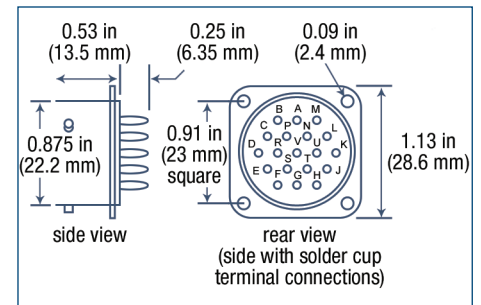

VFT19-FMC

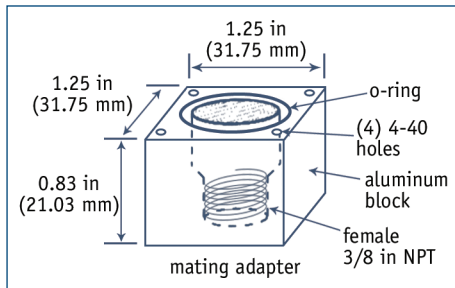

VFT19-MC

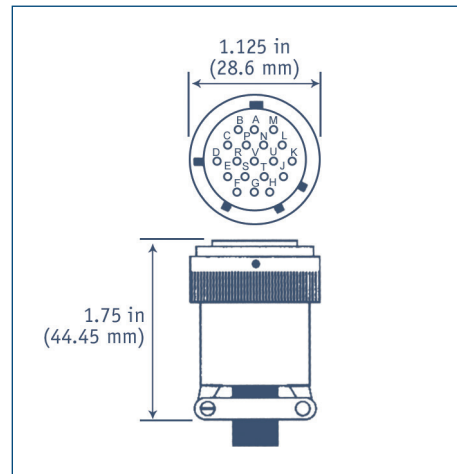

### Specifications

**Shell:** Mild steel

**Contacts:** High nickel iron alloy

**Finish:** Fused tin over cadmium

### Ordering information

Part number	Description
VFT19	19-pin vacuum feedthrough
VFT19-F	19-pin vacuum feedthrough in flange
VFT19-FMC	Mating adapter for mounting VFT19-F to 3/8 NPT hole pipe feedthrough
VFT19-MC	Mating connector plug to VFT19-F



## 4-lead resistance sample holder

- 4 pre-tinned and drilled solder pads
- Plug-in convenience (4-pin plug)
- Mating socket included

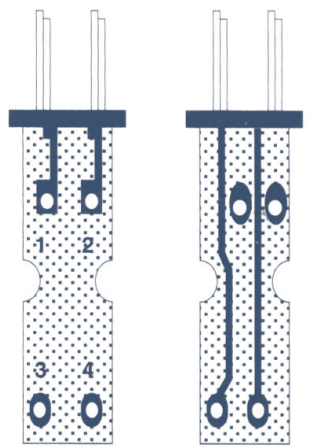

Front view Rear view

### Specifications

**Temperature range:** 4.2 K to 373 K (-269 °C to 100 °C)

**Current:** 1 A at 100 VDC

**Insertion force:** 227 g (8 oz) per pin

**Dimensions:** 5.1 mm wide × 27.9 mm long (0.2 in wide × 1.1 in long)

**Hole diameter:** 0.8 mm (0.03125 in)

**Hole spacing:** 2.5 mm (0.1 in) between holes 1 & 2 and 3 & 4; 15.2 mm (0.6 in) between holes 1 & 4 and 2 & 3

**Mating connector:** Black thermoplastic

**Sockets:** Phosphor bronze with gold over nickel

**Socket diameter:** 0.41 mm to 0.51 mm (0.016 in to 0.020 in square)

**Socket depth:** 2.03 mm to 6.35 mm (0.080 in to 0.25 in)

### Ordering information

Part number	Description
700RSH	4-lead resistance sample holder and mating connector; 200 cycle minimum when used below room temperature





## Cartridge heaters

- Precision-wound nickel-chromium resistance wire
- Efficient magnesium oxide insulation
- CSA component recognition
- 2 solid pins
- High-temperature rated INCOLOY® case\*

\*The nickel lead wires and INCOLOY (iron/nickel/chromium alloy) case make these heaters unsuitable for magnetically sensitive locations

6.248 ± 0.076 mm  
(0.246 ± 0.003 in)

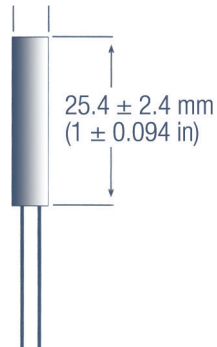

Lake Shore cartridge heaters can be used with all of our temperature controllers. Heaters have wattage ratings in dead air. In cryogenic applications, these cartridge heaters can handle many times the rated value if properly heat sunk or in liquid.

### Specifications

**Diameter:** 6.248 mm ± 0.076 mm (0.246 in ± 0.003 in) recommended to fit hole of 6.35 mm (0.25 in)

**Insulation between leads and case:** Magnesium oxide\*\*

**Leads:** Nickel, 0.635 mm (0.025 in) diameter × 50.8 mm (2 in) long

\*\*Dielectric strength of insulation is reduced when hot, forming leakage current

### Ordering information

Part number	Length	V	Ω	W
HTR-50	25.4 ± 2.4 mm	50	50	50
HTR-25-100	(1 ± 0.094 in)	50	25	100



## Electrical tape for use at cryogenic temperatures

- Excellent tape for use at cryogenic temperatures—does not degrade with time like masking tape
- CHR Industries electrical tape
- Yellow polyester film

### Specifications at 25 °C

**Backing:** Polyester film

**Temperature class (upper limit):** 403 K (130 °C)

**Total thickness:** 0.064 mm (0.0025 in)

**Dielectric breakdown:** 5 kV

**Insulation resistance:** >1 MΩ

**Breaking strength:** 55 N (12.5 lb)

**Elongation:** 100% at break

### Ordering information

Part number	Description
T3M-72	1 roll cryogenic tape 12.7 mm × 65.8 m (0.5 in × 72 yd)



## Ferrite bead for high frequency filtering

RF pickup can affect an experiment by upsetting the instrument reading, by being rectified by a diode thermometer to appear as an offset, or by transmitting through the system wiring to pollute the experimental environment. A ferrite bead will reduce the effect of RF pickup on instrument leads by acting like a high impedance (resistance) to high frequency noise. DC and slow moving signals are not affected. The bead can be clamped around existing wiring for ease of installation.

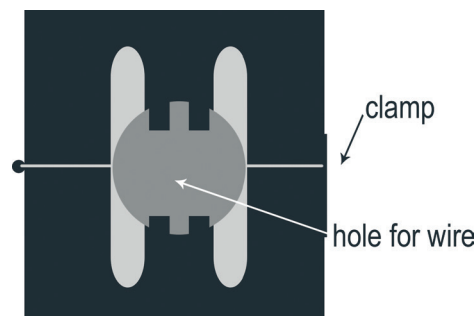

### Specifications

**Material:** Fair-Rite® 43

**Impedance with wire passed once through bead:**

110 Ω at 25 MHz, 225 Ω at 100 MHz

**Impedance with wire passed twice through bead:**

440 Ω at 25 MHz, 900 Ω at 100 MHz

**Construction:** 2 halves of a ferrite bead held by a plastic clamp

**Overall dimensions:** 22.1 mm × 23.4 mm × 32.3 mm  
(0.87 in × 0.92 in × 1.27 in)

**Cable opening diameter:** 10.2 mm (0.4 in)

**Temperature range:** 288 K to 308 K (15 °C to 35 °C)

Weight: 0.046 kg (0.1 lb)

### Ordering information

Part number	Description
2071	Ferrite bead











# Appendices

- 156 **Appendix A: Overview of Thermometry**
- 158 **Appendix B: Sensor Characteristics**
- 168 **Appendix C: Sensor Packaging and Installation**
- 181 **Appendix D: Sensor Calibration Accuracies**
- 190 **Appendix E: Temperature Measurement System**
- 199 **Appendix F: PID Temperature Control**
- 202 **Appendix G: Sensor Temperature Response Data Tables**
- 207 **Appendix H: Common Units and Conversions**
- 209 **Appendix I: Cryogenic Reference Tables**





# Appendix A: Overview of Thermometry

## General thermometry and temperature scales

Thermodynamically speaking, temperature is the quantity in two systems which takes the same value in both systems when they are brought into thermal contact and allowed to come to thermal equilibrium. For example, if two different sized containers filled with different gasses at different pressures and temperatures are brought into thermal contact, after a period of time, the final volumes, pressures, entropies, enthalpies, and other thermodynamic properties of each gas can be different, but the temperature will be the same.

Thermodynamically, the ratio of temperature of two systems can always be determined. This allows a thermodynamic temperature scale to be developed, since there is an implied unique zero temperature. Additionally, it allows the freedom to assign a value to a unique state. Therefore, the size of a temperature unit is arbitrary.

The SI temperature scale is the Kelvin scale. It defines the triple point of water as the numerical value of 273.16, i.e., 273.16 K. The unit of temperature in this scale is the kelvin (K).

Another scale is the Rankine scale, where the triple point of water is defined as the value 491.688 °R (degrees Rankine). On the Rankine scale, temperature is 9/5 the Kelvin temperature.

The Kelvin and Rankine scales are both thermodynamic, however, other non-thermodynamic scales can be derived from them. The Celsius scale has units of °C (degrees Celsius) with the size of the unit equal to one Kelvin.

$$T(^{\circ}\text{C}) = T(\text{K}) - 273.15 \quad \text{Eqn. 1}$$

While the Fahrenheit scale is defined as

$$T(^{\circ}\text{F}) = T(^{\circ}\text{R}) - 459.67 \quad \text{Eqn. 2}$$

Additionally,

$$T(^{\circ}\text{C}) = [T(^{\circ}\text{F}) - 32] * (5/9) \quad \text{Eqn. 3}$$

Both Celsius and Fahrenheit are non-thermodynamic temperature scales, i.e., the ratio of temperature is not related to thermodynamic properties (a 50 °F day is not two times “hotter” than a 25 °F day!) These scales are used for their pragmatic representation of the range of temperature that is experienced daily.

At the most basic level, a thermometer is a device with a measurable output that changes with temperature in a reproducible manner. If we can explicitly write an equation of state for a thermometer without introducing any unknown, temperature-dependent quantities, then we call that thermometer a **primary** thermometer. These include the gas thermometer, acoustic thermometer, noise thermometer, and total radiation thermometer. A **secondary** thermometer has an output that must be calibrated against defined fixed temperature points. For example, a platinum resistance temperature detector (RTD) is based on the change in resistance of a platinum wire with temperature.

Since primary thermometers are impractical (due to size, speed, and expense), secondary thermometers are used for most applications. The common practice is to use secondary thermometers and calibrate them to an internationally recognized temperature scale based on primary thermometers and fixed points. The most recent efforts in defining a temperature scale have resulted in the International Temperature Scale of 1990 (ITS-90) and the Provisional Low Temperature Scale of 2000 (PLTS-2000).

The ITS-90 is defined by 17 fixed points and 4 defining instruments. It spans a temperature range from 0.65 K to 10,000 K. For cryogenic purposes the three defining instruments are helium vapor pressure thermometry, gas thermometry, and platinum resistance thermometry.

For temperature below 1 K there is the Provisional Low Temperature Scale of 2000 (PLTS 2000). The PLTS-2000 is defined by a polynomial relating the melting pressure of He3 to temperature from the range 0.9 mK to 1 K. The pressure to temperature relationship is based on primary thermometers such as Johnson noise and nuclear orientation. Realization of the PLTS-2000 requires a helium-3 melting pressure thermometer (MPT). For the best realization of PLTS-2000, an MPT with an absolute pressure standard is used. This is a costly and time consuming method. Another method is to use the MPT as an interpolating instrument in conjunction with superconducting fixed points.

Few, if any, individuals or laboratories can afford the expense of maintaining the equipment necessary for achieving the ITS-90 and PLTS-2000. It is more customary to purchase thermometers calibrated by a standards laboratory. Even then, this thermometer is typically two or three times removed from primary thermometers.



Normally the temperature scale, once defined, is transferred from the primary thermometers to secondary thermometers maintained by government agencies, such as the National Institute of Standards and Technology (NIST), the National Physical Laboratory (NPL), or the Physikalisch-Technische Bundesanstalt (PTB). The most common of these secondary thermometers is the resistance thermometer, which is normally a high purity platinum or a high purity rhodium-iron alloy. Standards grade platinum resistance thermometers are referred to as standard platinum resistance thermometers (SPRT) while rhodium-iron resistance thermometers are referred to as RIRTs. Both materials are highly stable when wire-wound in a strain-free configuration. These standards grade resistance thermometers are maintained for calibrating customers' thermometers in a convenient manner. A standards laboratory would maintain a temperature scale on a set of resistance thermometers calibrated by that government agency. This is extremely expensive and time consuming. Thus, primary standards would not be used in day-to-day operation. Instead, the standards laboratory would calibrate a set of working standards for that purpose. These are the standards used to calibrate thermometers sold to customers. Each step in the calibration transfer process introduces a small additive error in the overall accuracy of the end calibration.

In addition to the sensor calibration process, there is also a class of sensors where the manufacturing process is highly reproducible. All of these sensors have a similar output to temperature response curve to within a specified tolerance. Industrial grade platinum thermometers and silicon diodes are examples of sensors that are interchangeable, i.e., their output as a function of temperature (R vs. T or V vs. T) is so uniform that any sensor can be interchanged with another—without calibration—and the temperature reading will still be accurate. The level of accuracy is specified by tolerance bands. With silicon diodes it is possible for a sensor to be interchangeable to within 0.25 K.

#### References:

Schooley, James F. **Thermometry**. Boca Raton, Florida: CRC Press Inc., 1986.

Quinn, T.J. **Temperature**. Academic Press, 1983.

Callan, H.B. **Thermodynamics and an introduction to Thermostatistics, Second Edition**, New York: Wiley, 1985.

Mangum, B. W. and G. T. Furukawa. **Guidelines for Realizing the International Temperature Scale of 1990 (ITS-90)**. NIST Technical Note 1265, 1990.

#### Fixed points

Repeatable temperature points are referred to as fixed points. These are simply points that occur reproducibly at the same temperature. There are numerous examples of fixed points. These include boiling points, freezing points, triple points, superconducting transition points, and superfluid transition points.

Figure 1 shows a typical pressure-temperature phase diagram. Matter can exist in three states: solid, liquid, and gas. The pressure-temperature diagram intuitively makes sense. If we heat matter to a high enough temperature, it becomes gaseous. If we subject matter to a high enough pressure, it becomes a solid. At combinations of pressure and temperature in between these limits, matter can exist as a liquid. The boundaries that separate these states of matter are called the melting (or freezing) curve, the vaporization (or condensation) curve and the sublimation curve. The intersection of all three curves is called the triple point. All three states of matter can coexist at that pressure and temperature. When we say the freezing point or boiling point of a substance is reproducible, it is implied that we are measuring that point at the same nominal pressure as in previous measurements. As is shown in the diagram, there is not a single freezing point or a single boiling point. There are an infinite number of freezing points and boiling points which form the boundaries between the solid and liquid states of matter. There is, however, a single triple point, which makes it inherently reproducible. There is only one combination of pressure and temperature for a substance that allows the triple point to be obtained.

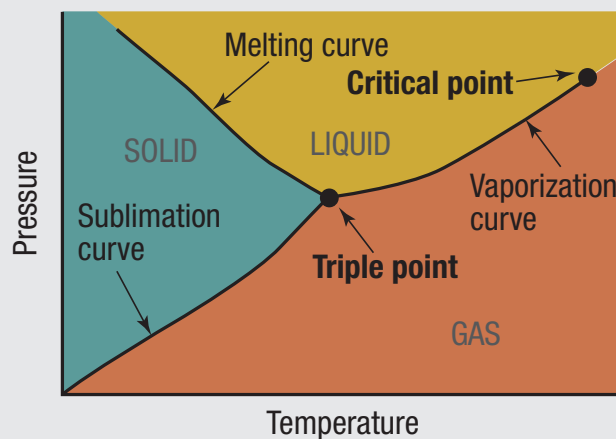

Figure 1 – generic pressure vs. temperature curve



## Appendix B: Sensor Characteristics

### Types of temperature sensors

Any temperature dependent parameter can be used as a sensor if it fits the requirements of the given application. These parameters include resistance, forward voltage (diodes), thermal EMFs, capacitance, expansion/contraction of various materials, magnetic properties, noise properties, nuclear orientation properties, etc. The two most commonly used parameters in cryogenic thermometers are voltage (diodes) and resistance. There are distinct reasons for choosing diode thermometry or resistance thermometry.

### Diodes

A diode temperature sensor is the general name for a class of semiconductor temperature sensors. They are based on the temperature dependence of the forward voltage drop across a p-n junction. The voltage change with temperature depends on the material. The most common is silicon, but gallium arsenide and gallium aluminum arsenide are also used.

Silicon diodes can be used from 1.4 K to 500 K. From 25 K to 500 K, a silicon diode has a nearly constant sensitivity of 2.3 mV/K. Below 25 K the sensitivity increases and is nonlinear. The temperature response curve is shown in Figure 1. Diode temperature sensors from Lake Shore (DT-670 Series) typically are mounted in a special semiconductor package (SD package). The semiconductor packaging is robust and allows for solder mounting for probes and circuits and easy installation and handling.

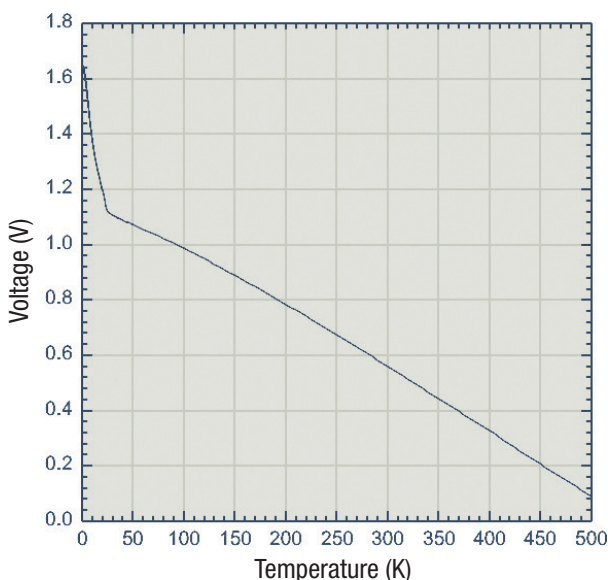

Figure 1 – Curve DT-670

Silicon diode sensors are typically excited with a constant  $10\ \mu\text{A}$  current. The output signal is fairly large: 0.5 V at room temperature and 1 V at 77 K. This can be compared to platinum where a  $100\ \Omega$  PRT with a 1 mA excitation has only a 100 mV signal at 273 K. The straightforward diode thermometry instrumentation is shown in Figure 2.

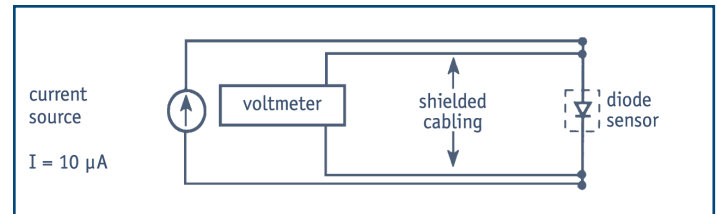

Figure 2 – Typical diode sensor instrumentation schematic

An important feature of silicon diodes is their interchangeability. Silicon diodes from a particular manufacturer are interchangeable, or curve-matched over their whole range. This is typically defined in terms of tolerance bands about a standard voltage-temperature response curve. They are classified into different tolerance bands with the best accuracy being about  $\pm 0.25\ \text{K}$  from 2 K to 100 K and  $\pm 0.3\ \text{K}$  from 100 K to 300 K.

The large temperature range, nearly linear sensitivity, large signal and simple instrumentation make the diode useful for applications that require a better accuracy than thermocouples. Also, because of the large signal, a diode can be used in a two-lead measurement with little lead resistance error. AC noise-induced temperature errors, to which resistors are immune (aside from heating effects), can be prevalent in diodes.

### Resistors

Temperature sensors based on the changing resistance with temperature can be classified as positive temperature coefficient (PTC) or negative temperature coefficient (NTC). Platinum RTDs are the best example of PTC resistance sensors. Other PTC RTDs include rhodium-iron, nickel, and copper RTDs. Figure 3 shows a typical resistance sensor instrumentation schematic.

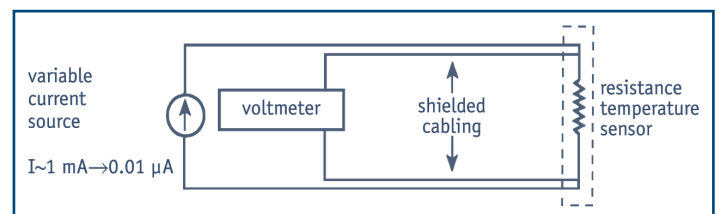

Figure 3 – Typical resistance sensor instrumentation schematic



A PTC RTD is typically metallic (platinum) and has a fairly linear temperature-resistance response. NTC RTDs are semiconductors or semi-metals (doped germanium, Cernox®). They have extremely nonlinear response curves, but are much more sensitive to temperature change.

**Positive temperature coefficient (PTC) RTDs**—The most common type of PTC RTD is platinum. Platinum RTDs are the industry standard due to their accuracy and reproducibility over a wide range of temperatures, as well as their interchangeability. Measurements in the range from -258 °C to 600 °C are routinely made with a high degree of accuracy using platinum RTDs. Industrial-grade platinum RTDs are wire-wound devices that are encapsulated in glass or ceramic, making them durable for general-purpose use.

Platinum RTDs follow a standard response curve to within defined tolerances (IEC 751). The industry standard for class B accuracy is specified as  $\pm 0.3$  K and  $\pm 0.75\%$  variation in the specified  $0.00385$  K<sup>-1</sup> temperature coefficient of resistance at 273 K. Below 70 K, a platinum RTD is still usable but requires an individual calibration.

Like all resistors, platinum RTDs can be measured by current excitation or voltage measurement. Common configurations are two-, three-, and four-lead measurements. Two-lead measurements do not correct for lead resistance, so therefore can only be used in applications where the sensor is close to a temperature transmitter. Because their resistance change with temperature is linear over a wide range, a single current excitation (1 mA) can be used for the whole range.

**Negative temperature coefficient (NTC) RTDs**—NTC resistors are normally semiconductors with a very strong temperature dependence of resistance, which decreases with increasing temperature. It is not uncommon for the resistance to change five orders of magnitude over their useful temperature range. The three most common are germanium, Cernox®, and ruthenium oxide (Rox™) RTDs. Carbon-glass RTDs are still used, but they are generally being replaced by Cernox® for nearly all applications.

Cernox® is the trade name for zirconium oxy-nitride manufactured by Lake Shore Cryotronics, Inc. It is a sputter-deposited thin film resistor. Cernox shows good temperature sensitivity over a wider range (0.1 K to 420 K) and is highly resistant to magnetic field-induced errors and ionizing radiation. Cernox can be packaged in the same robust hermetically sealed SD package (Figure 4) that is used for diode temperature sensors. This makes Cernox more robust than other NTC RTDs.

Germanium and carbon-glass (Figures 5 and 6) have very large sensitivities, but more narrow operating ranges than Cernox. Germanium is very stable and is recognized as a secondary standard for  $T < 30$  K. Both sensors are piezoresistive, so the sensing element must be mounted in a strain-free package, which

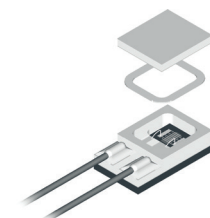

Figure 4 – CX-SD

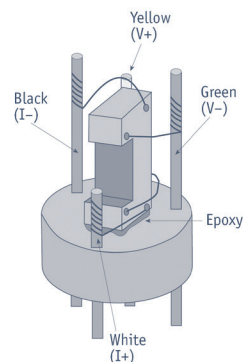

Figure 5 – Typical germanium packaging

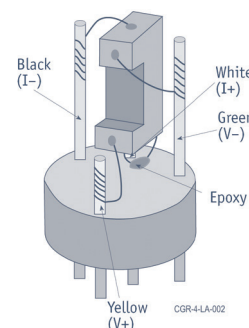

Figure 6 – Typical carbon-glass packaging

provides a very weak thermal link to their surroundings. Both sensors are sealed in a helium atmosphere, but at lower temperatures the pressure is very low and the gas eventually liquefies, reducing the thermal contact. The requirement of strain-free mounting also results in a very fragile sensor. Dropping a sensor from a height of a few centimeters can cause shifts in the calibration.

Ruthenium oxide is a generic name for a class of bismuth ruthenate thick-film resistors. They are epoxied to a BeO header, mounted, and sealed in gold-plated copper AA canisters. Unlike other NTC RTDs, Ruthenium oxide resistors are interchangeable and follow a standard curve. They can be used to below 50 mK and up to 40 K. Their sensitivity is negligible for  $T > 40$  K.

For NTC RTD temperature sensors, up to 70% of the thermal connection to the sensor is through the leads. The large resistance change coupled with thermal considerations results in a requirement for a variable current source for measurement in which the current must be varied over several orders of magnitude (i.e., from about  $< 0.01$   $\mu$ A to 1 mA or above) as well as a voltmeter capable of measuring voltages near 1 mV.

### Capacitors

Capacitors are also used for low temperatures, but usually not for temperature measurement. Capacitance temperature sensors have the advantage of being insensitive to magnetic fields, but they commonly experience calibration shifts after thermal cycling and the SrTiO<sub>3</sub> capacitors have been known to drift over time while at low temperatures. Phase shifts in the ferroelectric materials are probably the cause of the thermal cycling shifts. The time response of capacitance sensors is usually limited by the physical size and low thermal diffusivity of the dielectric material. The capacitance is measured by an AC technique.



### Thermocouples

Thermocouples are only useful where low mass or differential temperature measurements are the main consideration. They must be calibrated in-situ because the entire length of the wire contributes to the output voltage if it traverses a temperature gradient. Errors of 5 K to 10 K can easily occur.

### Sensor selection

The most important question to ask when selecting a temperature sensor and instrumentation system is “What needs to be measured?” A simple question, but it can be surprisingly easy to answer incorrectly. Some processes need extremely high resolution over a narrow temperature range. Other systems need only a gross estimate of the temperature but over a very wide range.

Design requirements dictate the choice of temperature sensor and instrumentation. Not all applications require the same choice. Even within an application, different temperature sensors can be required. Selecting the appropriate sensor requires prioritizing the most important design attributes. Some attributes are not exclusive to others: The most stable sensors also have a very slow response rate and can be expensive, while sensors with the highest sensitivity have the smallest range.

Design requirements can be classified into four categories:

**Quality of measurement**—This concerns measurement uncertainty, resolution, repeatability, and stability.

**Experimental design**—This is related to constraints due to the experiment (or cryogenic system). It concerns the physical size of the sensors, temperature range of operation, and power dissipation.

**Environmental constraints**—These are effects due to external conditions such as magnetic fields or ionizing radiation. Other external constraints would be vibration or ultra high vacuum.

**Utility requirements**—These are primarily requirements for cost, ease of use, installation, packaging, and long-term reliability.

### Quality measures

### Accuracy versus uncertainty

The term “accuracy” has been almost universally used in literature when presenting specifications, and is often used interchangeably with uncertainty. However, from a strict metrology viewpoint, a distinction does exist between accuracy and uncertainty. Accuracy refers to the closeness of agreement between the measurement and the true value of the measure quantity. Accuracy is a qualitative concept and should not have numbers associated with it. This can be understood since, in practice, one does not have a priori knowledge of the true value of the measured quantity. What one knows is the measured value and its uncertainty, i.e., the range of values which contain the true value of the measured quantity. The uncertainty is a quantitative result and the number typically presented in specifications.

In any proper measurement, an estimate of the measurement uncertainty should be given with the results of the measurement. There are often many sources that contribute uncertainties in a given measurement, and rigorous mathematical methods exist for combining the individual uncertainties into a total uncertainty for the measurement. Temperature sensors, installation, environment, instrumentation, thermal cycling, and thermal EMFs can all contribute to the measurement uncertainty.

A sensor calibration is a method to assign voltage or resistance measurements to a defined temperature scale (i.e., ITS-90 or PLTS-2000). The level of confidence at which this can be done (measuring voltage or resistance AND transferring those values to a defined temperature) is defined by the uncertainty of the calibration.

The uncertainty of the Lake Shore calibration is only one component in a customer measurement system.

It is possible to degrade this accuracy specification by as much as one or two orders of magnitude with improper installation and/or poor shielding and measurement techniques.

### Repeatability (of the measurement)

The exact definition of repeatability is the closeness of the agreement between the results of successive measurements of the same measurand carried out under the same conditions of measurement (repeatable conditions).

Repeatability is a measure of how well a sensor repeats its measurement under the same conditions. This is often thought of as measurement performed over a period of time (seconds, minutes, hours) at the same temperature. This property is often called precision or stability of the measurement. This value is primarily an instrumentation specification. The sensors themselves are very stable under successive measurements. The stability of the instrument used to measure the sensor needs to be included.

### Reproducibility



The definition of reproducibility is the closeness of agreement between the results of the measurements of the same measurand carried out under changed conditions of measurements. Often the changed conditions are thermal cycling or mounting (or unmounting) of the sensors. Temperature sensors are complex combinations of various materials bonded together. Aging, thermal cycling, mechanical shock from handling, etc. all affect the reproducibility.

Lake Shore quantifies the reproducibility under thermal cycling in two manners:

*Short-term reproducibility:* Changes in response values under repeated, successive cycles from ambient to liquid helium (4.2 K).

*Long-term stability:* Changes in response after 200 thermal shocks in LN<sub>2</sub> (77 K). Calibrations are performed prior to and after the thermal cycles.

Actual long-term stability for a specific sensor depends on the treatment of the sensor in terms of handling and thermal cycling. A single mechanical shock can cause an immediate calibration shift.

Users should include the short-term reproducibility value in their total uncertainty estimates.

### Sensitivity and resolution

Sensitivity can be presented in a variety of ways. Typically, it is given in terms of the signal sensitivity, which is the change in a measured parameter per change in temperature (Ω/K or V/K). These sensitivities can be a very strong function of temperature. Diodes have sensitivities that range from 2 mV/K to 180 mV/K. Resistor sensitivities can range from less than 0.001 Ω/K to 1,000,000 Ω/K, depending upon the device type and temperature.

For resistors, the above signal sensitivity (dR/dT) is geometry dependent (i.e., dR/dT scales directly with R), consequently, very often this sensitivity is normalized by dividing by the measured resistance to give a sensitivity, S<sub>r</sub>, in change per kelvin

$$S_r = (1/R)(dR/dT), \quad \text{Eqn. 1}$$

where T is the temperature in kelvin and R is the resistance in ohms. This is a common method to express the sensitivity of metal resistors like platinum RTDs.

When comparing different resistance sensors, another useful

materials parameter to consider is the dimensionless sensitivity. The dimensionless sensitivity S<sub>D</sub> for a resistor is a material-specific parameter given by

$$S_D = (T/R)(dR/dT) = d(\ln R)/d(\ln T) \quad \text{Eqn. 2}$$

Equivalent definitions are made for diodes with resistance replaced by forward voltage and for capacitors with resistance replaced by capacitance. S<sub>D</sub> is also the slope of the resistance versus temperature on a log-log plot, normally used to illustrate resistance versus temperature for negative temperature resistance sensors since their resistance varies by many orders of magnitude. S<sub>D</sub> ranges from 0.2 to 6 for most common cryogenic temperature sensors, depending on temperature and sensor type.

Temperature resolution is the smallest temperature difference that can be determined by your measurement system and sensor choice. It is a combination of sensor sensitivity and instrument resolution (ΔR). It can be expressed as

$$\Delta T = \Delta R / (dR/dT) \quad \text{Eqn. 3}$$

(or as a ratio  $\Delta T/T = (\Delta R/R)/S_D$ )

Instrument manufacturers will either express the resolution of the measurement as fraction of full scale (i.e., 1 part per million) or as an absolute ΔR (i.e., 1 Ω for 10,000 Ω scale). Do not confuse temperature resolution with display resolution; actual temperature resolution can be greater or less than the digital display resolution.

### Experimental design

#### Range of use

Two factors limit the useful range of a sensor. First, the physical phenomena responsible for the temperature dependence of the property being measured must occur at a measurable level in both absolute signal and sensitivity to temperature change. Second, the materials used in construction of the temperature sensor must be appropriate to the temperature range of use. Materials such as epoxies, solders, and insulators that are very useful at low temperatures can break down at higher temperatures. Exposure to extreme temperatures (either high or low) can induce strains in the sensor due to changes in the packaging materials or in the leads; the resulting strain can cause a shift in the low temperature calibration for that sensor.

#### Physical size, construction, and thermal response times



As a general rule, larger sensors will be more stable, but they may have a longer thermal response time and may not fit into many experimental schemes. This can be somewhat deceptive, however, because the actual thermal response time depends integrally upon the physical construction of the sensor (i.e., the temperature sensing element) and its associated packaging. Strain-free mounting of sensor elements inside the package necessarily makes for poor thermal connection and longer thermal response times. The choice of package materials can also have a great effect on thermal response times at low temperatures.

Thermal response times are determined by physical construction material and mass of the temperature-sensing element. Strain-free mounted sensors tend to have longer thermal response times. Diode sensors that are mounted directly on a sapphire substrate will be in very good thermal contact with the surroundings and hence have short thermal response times. Thermal response times for various sensors are given in Table 1. The values listed are the 1/e response times.

**Table 1—Thermal response times**

	4.2 K	77 K	273 K
DT-470-SD	<10 ms	100 ms	200 ms
DT-420	<10 ms	50 ms	NA
CX-XXXX-BC	1.5 ms	50 ms	135 ms
CX-XXXX-SD	15 ms	250 ms	0.8 s
CX-XXXX-AA	0.4 s	1 s	1 s
GR-200A-1000	200 ms	3 s	NA
CGR-1-1000	1 s	1.5 s	NA
PT-102	NA	1.75 s	12.5 s
PT-111	NA	2.5 s	20 s

### Power dissipation

Diode, resistance, and capacitance temperature sensors must all be energized electrically to generate a signal for measurement. The power dissipated within the temperature sensor must be appropriate for the temperature being measured; the joule heating within the temperature sensor causes an incremental temperature rise within the sensor element itself (self-heating). Consequently, this temperature rise must be kept negligible compared to the temperature of interest.

For diodes, a fixed excitation current of 10  $\mu$ A is a compromise between power dissipation and noise immunity. The power dissipated is the product of voltage times current. Since the voltage increases with decreasing temperature, power also increases, resulting in a practical lower temperature limit for diode thermometers of slightly above 1 K.

Resistors, on the other hand, have a linear I-V relationship that allows (at a fixed temperature) the measurement of resistance at many different currents and voltages. Since positive temperature

coefficient resistance temperature sensors vary relatively linearly with temperature, they can normally be measured by utilizing a fixed current chosen such that self-heating over the useful temperature range is minimized.

In the case of negative temperature coefficient resistance temperature sensors such as Cernox<sup>®</sup> or germanium RTDs, resistance can vary by as much as five orders of magnitude. To keep the joule heating low, their resistance must be measured either at a fixed voltage or with a variable current selected to keep the resulting measured voltage between 1 mV and 15 mV.

Table 2 gives some typical values of appropriate power levels to use with various temperature sensors in various ranges. These power dissipation levels should keep the temperature rise below 1 mK.

**Table 2—Power (W)**

	Cernox <sup>®</sup> , germanium, Rox <sup>™</sup>	Platinum, rhodium-iron
0.02 K	10 <sup>-14</sup>	—
0.1 K	10 <sup>-10</sup>	—
1 K	10 <sup>-9</sup>	10 <sup>-7*</sup>
2 K to 10 K	10 <sup>-8</sup>	10 <sup>-6*</sup>
10 K to 100 K	10 <sup>-7</sup> to 10 <sup>-6</sup>	10 <sup>-5</sup>
273 K	10 <sup>-6</sup> (CGR, CX)	3 × 10 <sup>-5</sup>

\*Rhodium-iron only

### Environmental

#### Usefulness in magnetic fields

Probably the most common harsh environment that temperature sensors are exposed to is a magnetic field. Magnetic fields cause reversible calibration shifts, which yield false temperature measurements. The shift is not permanent and sensors will return to their zero-field calibration when the field is removed.

The usefulness of resistance temperature sensors in magnetic fields depends entirely on the particular resistance temperature detector (RTD) chosen. The Lake Shore Cernox<sup>®</sup> thin-film resistance sensors are the recommended choice for use in magnetic fields. The Cernox<sup>®</sup> sensors are offered in a variety of packages and have a wider temperature range than carbon-glass. Ruthenium oxide RTDs are a good choice for temperature below 1 K and down to 50 mK or lower. Due to their strong magnetoresistance and associated orientation effect, germanium sensors are of little use in magnetic fields.

Depending on the desired accuracy, silicon diodes can be used effectively in certain temperature ranges (<0.5% error above 60 K in 1 T fields). However, special care must be taken in mounting the diode to ensure that the junction is perpendicular to field, i.e., current





flow is parallel to the magnetic field. Diodes are strongly orientation dependent.

Capacitors are excellent for use in magnetic field environments as control sensors. They can be used in conjunction with another type of sensor (Cernox<sup>®</sup>, carbon-glass, germanium, etc.) to control temperature. The temperature is set using the other sensor before the field is turned on. Control is then accomplished with the capacitor. Table 3 (page 162) shows magnetic field dependence for some Lake Shore sensors.

### Usefulness in radiation

Ionizing radiation refers to a broad class of energetic particles and waves. The effects of radiation can produce temporary or permanent calibration shifts. The exposure can be measured using standard dosimetry techniques, but the actual absorbed dose will vary depending on the material. Due to extensive work performed on the effects of radiation on biological tissue and Si semiconductor devices, the dose is often expressed either in tissue equivalent dose or dose Si, i.e., grays (1 gray = 100 rad).

The data for neutron radiation is more difficult to interpret than gamma radiation data because effects occur due to both the neutrons and the associated background gamma radiation. In both cases it is difficult to calculate or measure the actual absorbed dose. The actual absorbed dose depends on dose rates, energy of the radiation, exposure dose, material being irradiated, etc. Figures 7a to 7e (pages 163 to 164) show data for various sensors.

### Usefulness in ultra high vacuum systems

The bakeout procedure performed in most ultra high vacuum systems can be damaging to the materials used in the construction of a temperature sensor. Even if the sensor withstands the high bakeout temperature, the sensor's calibration may shift. Without the bakeout, (and possibly with it) some materials in the sensor (Stycast<sup>®</sup>, for example) may interfere with the high vacuum by acting as a virtual leak. There can be a considerable outgassing from various types of epoxies and ceramics, and some of these materials would not survive the high temperature bake. With proper packaging, diodes, Cernox<sup>®</sup>, rhodium-iron, and platinum RTDs can be easily used in ultra high vacuum systems that require a high temperature bake out.

Specific factors to be aware of in an ultra high vacuum environment are:

- Check the compatibility of construction materials of the

sensor with ultra high vacuum before using it in such an environment. This includes thermal grease, epoxies, and solders (e.g., Apiezon<sup>®</sup> N grease cannot be used in these systems due to vapor pressure).

- Solders may not be compatible. Welding may be required.
- Typical insulation used for cryogenic wire may be incompatible with high temperature bakeouts and ultra high vacuums due to thermal ratings and outgassing.

The Lake Shore SD package for diodes is considered UHV compatible. A special package exists for the Cernox<sup>®</sup> sensor that uses spot welded platinum leads.

A useful website with more information on outgassing properties of materials is found at <http://outgassing.nasa.gov>.

### Vibration (shock) environments

Subjecting a temperature sensor to vibrations can permanently shift the calibration, either slowly or catastrophically. Sensors such as germanium and carbon-glass are mounted in a strain-free manner, and mechanical shocks due to vibration will have the same effect on the sensor as dropping it. Other sensors including Cernox<sup>®</sup> and silicon diodes, due to their physical construction and packaging are less susceptible to vibration-induced errors.

### Flight qualified

For special applications, Lake Shore will test and qualify sensors to flight standards. Silicon diode and Cernox<sup>®</sup> sensors, due to their characteristics, performance, construction, and packaging are ideally suited for many flight and large projects applications. Tests are performed to the required standards (for example MIL-STD-750 or MIL-STD-883). Some tests include burn-in lifetime tests, thermal shock, vibration, PIND, gross and fine leak (hermeticity), x-ray, and long and short-term stability.

### Utility

#### Interchangeability

It is very convenient and cost effective to have temperature

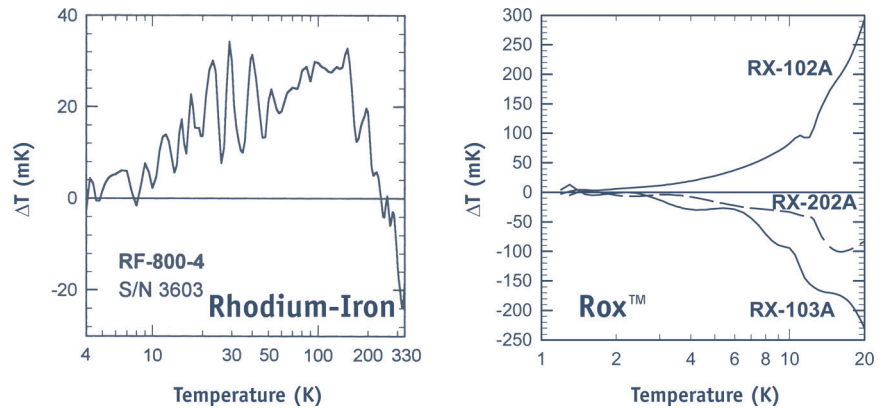

**Table 3—Typical magnetic field-dependent temperature errors  $\Delta T/T$  (%) at B (magnetic induction)**

	T(K)	Magnetic flux density B				Notes
		2.5 T	8 T	14 T	19 T	
Cernox® 1050 (CX series)	2	1.3	3.1	3.9	5	Best sensor for use in magnetic field (T > 1 K)
	4.2	0.1	-0.15	-0.85	-0.8	
	10	0.04	-0.4	-1.1	-1.5	
	20	0.04	0.02	-0.16	-0.2	
	30	0.01	0.04	0.06	0.11	
	300	0.002	0.022	0.062	0.11	
Carbon-glass resistors (CGR series)	4.2	-0.5	-2.3	-4.9	-6.6	
	10	-0.2	-1.1	-2.6	-3.8	
	25	0.02	0.22	0.54	0.79	
	45	0.07	0.48	1.32	2.2	
	88	0.05	0.45	1.32	2.3	
	306	<0.01	0.22	0.62	1.1	
Rox™ 102A	2	-1.4	-7.9	-13	-17	Recommended for use over the 0.05 K to 40 K temperature range. Consistent behavior between devices in magnetic fields.
	3	-1.5	-7	-14	-18	
	4	-0.56	-6.7	-14	-18	
	8	-1.3	-6.1	-13	-21	
	16	-0.40	-3.4	-9.6	-16	
	23	-0.31	-2.2	-6.2	-11	
Rox™ 103A	2	0.58	1.5	2.2	2.6	Excellent for use in magnetic fields from 1.4 K to 40 K. Predictable behavior.
	3	0.44	1.1	1.7	2.0	
	4	0.27	0.95	1.4	1.7	
	8	0.11	0.49	0.71	0.80	
	16	0.018	0.076	0.089	0.040	
	23	0.0051	0.0058	-0.0060	-0.095	
Rox™ 202A	2	-0.13	-2.2	-3.9	-5.2	Recommended for use over the 0.05 K to 40 K temperature range. Consistent behavior between devices in magnetic fields.
	3	0.18	-0.68	-2.7	-3.7	
	4	0.77	0.046	-1.8	-3.2	
	8	-0.023	0.16	-0.65	-3.0	
	16	0.03	0.16	-0.48	-1.5	
	23	-0.05	-0.08	-0.39	-0.92	
Platinum resistors (PT Series)	20	20	100	250	—	Recommended for use when T ≥ 40 K.
	40	0.5	3	6	8.8	
	87	0.04	0.4	1	1.7	
	300	<0.01	0.02	0.07	0.13	
Rhodium-iron (RF Series)	4.2	11	40	—	—	Not recommended for use below 77 K in magnetic fields.
	40	1.5	12	30	47	
	87	0.2	1.5	4	6	
	300	<0.01	0.1	0.4	—	
Capacitance CS-501 Series		$\Delta T/T(\%) < 0.015$ at 4.2 K and 18.7 T $\Delta T/T(\%) < 0.05$ at 77 K and 305 K and 18.7 T				Recommended for control purposes. Monotonic in C vs. T to nearly room temperature.
Germanium resistors (GR Series)	2.0	-8	-60	—	—	Not recommended except at low B owing to large, orientation-dependent temperature effect.
	4.2	-5 to -20	-30 to -55	-60 to -75	—	
	10	-4 to -15	-25 to -60	-60 to -75	—	
	20	-3 to -20	-15 to -35	-50 to -80	—	
Chromel-AuFe (0.07%)	10	3	20	30	—	Data taken with entire thermocouple in field, cold junction at 4.2 K; errors in hot junction.
	45	1	5	7	—	
	100	0.1	0.8	—	—	
Type E thermocouples (chromel-constantan)	10	1	3	7	—	Useful when T ≥ 10 K. Refer to notes for Chromel-AuFe (0.07%).
	20	<1	2	4	—	
	455	<1	<1	2	—	

	T(K)	1 T	2 T	3 T	4 T	5 T	Notes
Silicon diodes Junction parallel to field (DT Series)	4.2	-200	-300	-350	-400	-500	Strongly orientation dependent.
	20	-10	-20	-25	-30	-40	
	40	-4	-6	-8	-10	-12	
	60	-0.5	-1	-2	-3	-3.5	
	80	<0.1	-0.5	-0.8	-1.1	-1.5	
	300	<0.1	<-0.1	<-0.1	<-0.1	<-0.1	
Silicon diodes Junction perpendicular to field (DT Series)	4.2	-8	-9	-11	-15	-20	Strongly orientation dependent.
	20	-4	-5	-5	-5	-10	
	40	-1.5	-3	-4	-5	-5.5	
	60	-0.5	-1	-2	-3	-3.5	
	80	-0.1	-0.3	-0.5	-0.6	-0.7	
	300	<0.1	0.2	0.5	0.6	0.6	
GaAlAs diodes (TG Series)	4.2	2.9	3.8	3.7	2.8	1	Shown with junction perpendicular (package base parallel) to applied field B. When junction is parallel to B, induced errors are typically less than or on the order of those shown.
	30	0.2	0.2	0.3	0.3	0.2	
	78	<0.1	<0.1	0.17	0.16	0.1	
	300	-0.1	<0.1	<0.1	<0.1	<0.1	

**Figure 7a—Gamma rays**

Temperature shift as a function of temperature due to 10,000 Gy gamma radiation dose from a Cs-137 source. Dose rate was 0.5 Gy/min with irradiation performed at 298 K.

**Figure 7b—Neutrons and gamma rays**

Temperature shift as a function of temperature due to a  $2.5 \times 10^{12}$  neutron/cm<sup>2</sup> fluence from a nuclear pool reactor. The neutron flux was  $3.75 \times 10^7$  neutron/cm<sup>2</sup>/s with irradiation performed at 298 K (associated gamma ray dose of 29 Gy).

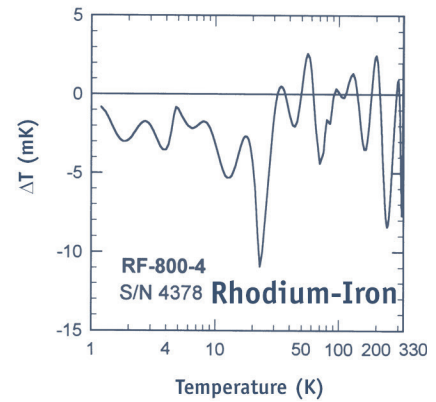
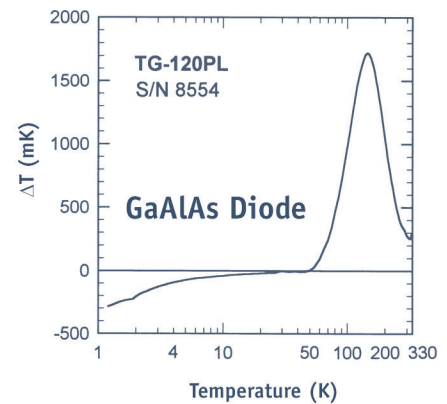
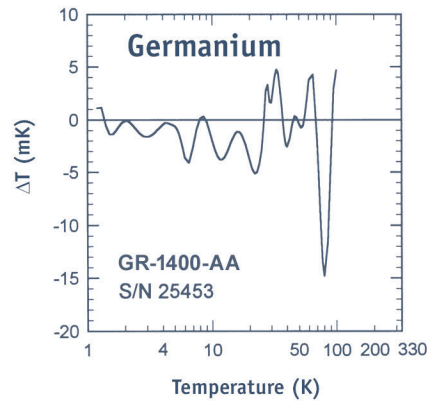
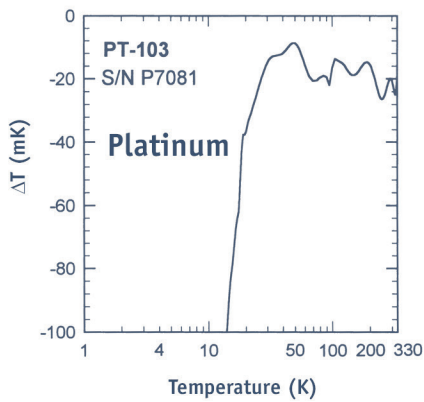



**Figure 7d—Gamma rays**

Temperature shift as a function of temperature due to 10,000 Gy gamma radiation dose from a Co-60 source. Dose rate was 40 Gy/min with irradiation performed at 4.2 K.

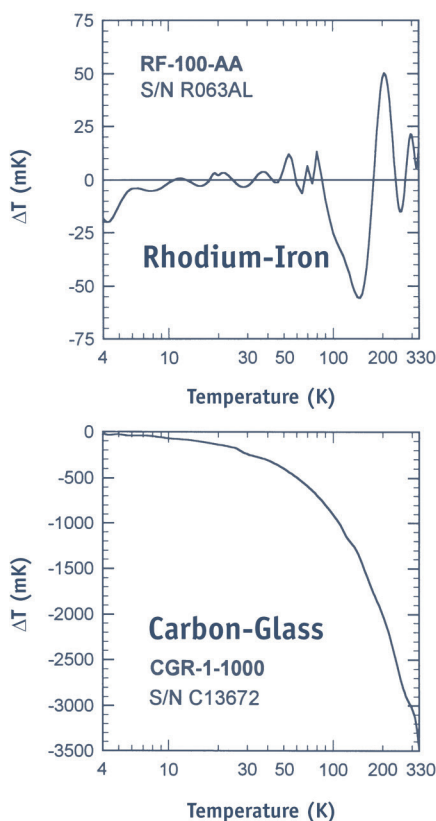

**Figure 7c—Neutrons and gamma rays**

Temperature shift as a function of temperature due to a  $10^{14}$  neutron/cm<sup>2</sup> fluence from a nuclear pool reactor. The neutron flux was  $2 \times 10^{12}$  neutron/cm<sup>2</sup>/s with irradiation performed at 298 K (associated gamma ray dose of 116 Gy).

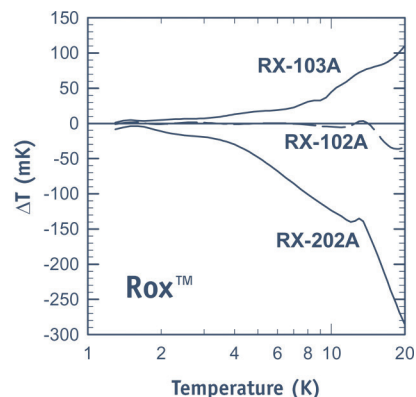

**Figure 7e—Neutrons and gamma rays**

Temperature shift as a function of temperature due to a  $2 \times 10^{12}$  neutron/cm<sup>2</sup> fluence from a nuclear pool reactor. The neutron flux was  $7.5 \times 10^7$  neutron/cm<sup>2</sup>/s with irradiation performed at 4.2 K (associated gamma ray dose of 23 Gy).

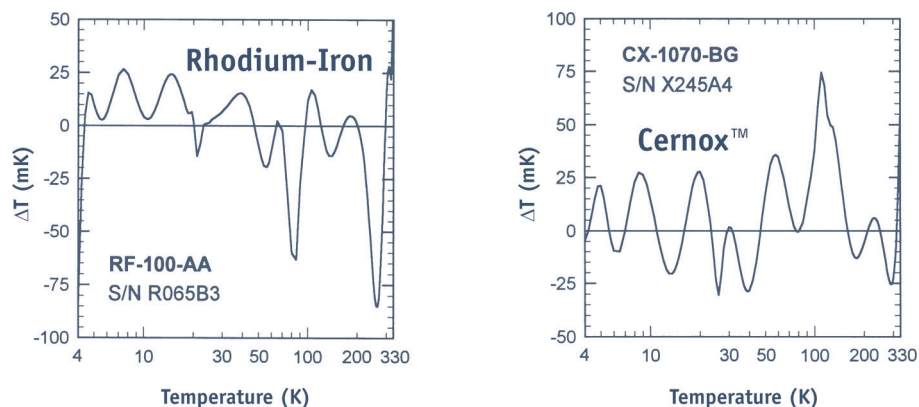



sensors that match a standard curve, thus not requiring individual calibration. Such sensors are termed “interchangeable.” In industry, interchangeable sensors make equipment design and manufacture simpler. Any monitoring equipment for those sensors can be identical. Time is saved in research settings since new calibrations do not have to be programmed into control and data acquisition equipment each time a new sensor is installed.

Some cryogenic temperature sensors exist at present which are interchangeable within a given tolerance band. Silicon diodes from Lake Shore are interchangeable. Series DT-670 diodes conform closely to a curve that Lake Shore calls Curve 670. The conformance is indicated by placing the diodes within tolerance bands. These sensors can be ordered by simply specifying a tolerance band. In this case, individual calibrations are not performed. If the greater accuracy is required, a calibration is necessary. Calibration can decrease the uncertainty by a factor of 10 or more. The DT-470 also follows a unique standard curve and is interchangeable with other DT-470s.

In addition to silicon diodes, platinum and ruthenium oxide RTDs both follow standard curves. Platinum RTDs match an industry standard curve (IEC 751) in terms of resistance versus temperature. Industrial platinum resistance temperature sensors are broken into Class B tolerances and Class A tolerances. Lake Shore offers only Class B sensors.

Ruthenium oxide RTD sensors also follow a standard curve. Like silicon diodes, this curve is unique to each manufacturer.

### Signal size

For resistors, values lie between approximately 10  $\Omega$  and 100,000  $\Omega$ . Resistance measurements outside this range become more difficult to perform, especially at ultra-low temperatures. Keep in mind that

for carbon-glass, Cernox<sup>®</sup>, and germanium sensors, there are several resistance ranges available to suit the appropriate temperature range(s). Because of their rapidly changing resistance and use at ultra-low temperature, it is necessary to use a small excitation current. The resulting voltage measurement can be in the nanovolt range in some cases. At these low voltages a variety of noise sources begin to affect the measurement.

Diode temperature sensors have a relatively large output (about 1 V) and a fixed current excitation of 10  $\mu$ A. This allows for simple instrumentation compared to NTC RTDs like Cernox<sup>®</sup>.

### Packaging

Sensors come in various packages and configurations. Apart from the size considerations discussed previously, there are practical considerations as well. A cylindrical package is obviously better suited for insertion into a cylindrical cavity than a flat or square-shaped package. Lake Shore offers a variety of sensor packages and mounting adaptors as well as probe assemblies. The most common package is the SD package. It is a robust and reliable hermetically sealed flat package. With a metallized and insulated bottom, the SD package can be indium soldered to the experimental surface. It can also be mechanically clamped as well as varnished or epoxied. The SD package can also be mounted into adaptor packages like the CU bobbin.

Many RTDs like germanium and Cernox<sup>®</sup> are mounted in cylindrical AA canisters. This is a requirement for GRTs due to their strain-free mounting. Cernox<sup>®</sup> is also available in a SD package.

Many cryogenic sensors can be packaged into custom probes and thermowells. Lake Shore has many standard probe configurations and can manufacture special customer designed probes for various applications.



# Appendix C: Sensor Packaging and Installation

## Installation

Once you have selected a sensor and it has been calibrated by Lake Shore, some potential difficulties in obtaining accurate temperature measurements are still ahead. The proper installation of a cryogenic temperature sensor can be a difficult task. The sensor must be mounted in such a way so as to measure the temperature of the object accurately without interfering with the experiment. If improperly installed, the temperature measured by the sensor may have little relation to the actual temperature of the object being measured.

**Figure 1—Typical sensor installation on a mechanical refrigerator**

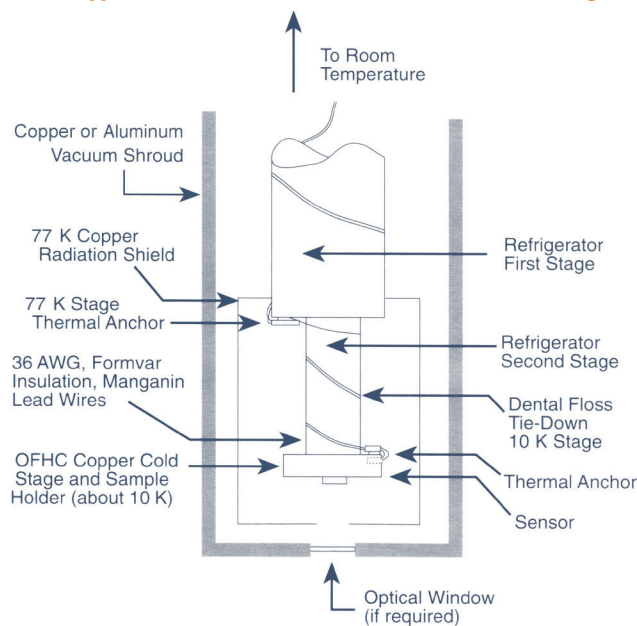

Figure 1 shows a typical sensor installation on a mechanical refrigerator. Note the additional length of lead wire wrapped around the refrigerator stages to minimize thermal conductance along the leads. If the optical radiation load through the window is large, the sample temperature will not necessarily be the same as that of the sensor in the block. A sensor placed in more intimate contact with the sample may be required.

## General installation considerations

Even with a properly installed temperature sensor, poor thermal design of the overall apparatus can produce measurement errors.

### Temperature gradients

Most temperature measurements are made on the assumption that the area of interest is isothermal. In many setups this may not be the case. The positions of all system elements—the sample, sensor(s), and the temperature sources—must be carefully examined to determine the expected heat flow patterns in the system. Any heat flow between the sample and sensor, for example, will create an unwanted temperature gradient. System elements should be positioned to avoid this problem.

### Optical source radiation

An often overlooked source of heat flow is simple thermal or blackbody radiation. Neither the sensor nor the sample should be in the line of sight of any surface that is at a significantly different temperature. This error source is commonly eliminated by installing a radiation shield around the sample and sensor, either by wrapping super-insulation (aluminized Mylar®) around the area, or through the installation of a temperature-controlled aluminum or copper shield (see Figure 1).

### 2-lead versus 4-lead measurement

4-lead measurements are recommended for all sensors. 2-lead measurements can be performed with diode sensors with a small increase in uncertainty. Refer to Appendix E: Temperature Measurement, for a detailed discussion.



### High temperature effects

Below room temperature, the primary effect of using dissimilar materials bonded together in sensing elements or packages is stress-induced by different expansion coefficients. Above room temperature, additional problems can occur. Alloying, diffusion (Kirkendahl voids), chemical reactions, and corrosion (especially in the presence of moisture and chlorine) accelerate as the temperature increases. These factors can cause catastrophic failure with time, or a shift in the sensor calibration. Completely accurate de-rating data for all situations that could be encountered is impossible to compile.

### Conduction (lead attachment)

Another source of heat flow that is often neglected is conduction through the electrical leads that run between the sensor and the ambient environment. 32- or 36-gauge, low thermal conductivity wire such as phosphor bronze or manganin is used to alleviate this problem. These leads must also be thermally anchored at several successive temperature points between ambient temperature and the sensor. Performing a 4-lead measurement will overcome the high lead resistance.

The physical mounting of the leads of a sensor is as important as the mounting of the sensor itself. Thermal contact to the active element in a cryogenic sensor occurs both through the sensor body and the electrical leads. In fact, for some sensors (e.g., germanium resistance thermometers) the primary thermal contact is through the leads. For accurate temperature readings, the sensor and its leads must be anchored so they are at the same temperature as the sample being measured. Table 1 shows typical heat sinking lengths.

**Table 1—Wire heat-sinking length required to thermally anchor to a heat sink at temperature T to bring the temperature of the wire to within 1 mK of  $T_{lower}$**

	$T_{upper}$ (K)	$T_{lower}$ (K)	Heat-sinking length (mm) for wire sizes			
			0.21 mm <sup>2</sup> (24 AWG)	0.032 mm <sup>2</sup> (32 AWG)	0.013 mm <sup>2</sup> (36 AWG)	0.005 mm <sup>2</sup> (40 AWG)
Copper	300	80	160	57	33	19
	300	4	688	233	138	80
Phosphor bronze	300	80	32	11	6	4
	300	4	38	13	7	4
Manganin	300	80	21	4	4	2
	300	4	20	7	4	2
304 SS	300	80	17	6	3	2
	300	4	14	5	3	2

Note: values are calculated assuming wires are in a vacuum environment, and the thermal conductivity of the adhesive is given by the fit to the thermal conductivity of VGE-7031 varnish

There are a number of ways in which sensor leads can be properly anchored, with the choice usually determined by the needs and constraints of the particular application. Longer leads may be wound directly around a sensor adaptor or another anchor adjacent to the sample and varnished into place. The varnish serves two purposes: it physically holds the leads in place, and it increases the contact surface area between the wire and the sample, or sample holder. VGE-7031 varnish is widely used as a low-temperature adhesive and can be easily removed with methanol. As long as the leads are electrically insulated with an enamel-type coating, such as Formvar® (see caution note) or polyimide, the varnished-down leads provide a suitable thermal anchor (thermal short) to their surroundings. Leads with heavy insulation, such as Teflon®, minimize the potential for making a thermal short to the surroundings, resulting in more thermal conduction down the leads into the sensing element. Resulting temperature measurement errors can be significant.

#### TIP: maintain electrical isolation

To maintain good electrical isolation over many thermal cycles, a single layer of cigarette paper can be varnished to the thermal anchor first, and the wire then wound over the paper and varnished down. The actual sensor leads are then soldered to this thermally anchored lead wire after the sensor body is mounted. For a more permanent installation, replace the VGE-7031 varnish with a suitable epoxy such as Stycast® 2850-FT.

#### Caution: varnish can cause crazing of Formvar® insulation.

One can make a separate thermal anchor to which the thermometer leads are attached. A typical technique for producing a physically compact anchor uses small gauge wire (32 AWG) insulated with Formvar®, polyimide, or a similar coating. The wire is wound around the sample in a bifilar manner or onto a separate bobbin and bonded with varnish. For most applications, a bonded length of 5 cm to 10 cm provides a sufficient thermal anchor unless poor practices elsewhere in the system permit excessive heat leaks down the leads. Copper wire may require several meters for heat sinking.

**What you may need:****Wire**

- ✓ Phosphor bronze
- ✓ Manganin
- ✓ Nichrome
- ✓ Copper
- Constantan
- ✓ Stainless steel coaxial cable

**Solders**

- 60/40 lead/tin
- ✓ 90/10 lead/tin
- ✓ Silver
- ✓ Ostalloy® 158 (Wood's metal)
- Indium-silver
- ✓ Indium

**Fluxes**

- RMA
- Keep Clean flux
- Stay Clean flux
- Stay Silv® flux

**Insulating materials**

- Ceramics
- Masking tape
- ✓ Polyester tape
- Kapton® films
- Teflon® tape
- Heat shrink tubing
- G-10
- Mylar® (polyester film)
- Fiberglass sleeving
- ✓ Epoxies
- ✓ VGE-7031 varnish
- ✓ Stycast® 2850 FT epoxy
- Cigarette paper
- ✓ Greases (Apiezon® N & H)

**Conducting materials**

- ✓ Silver filled epoxy
- Silver conductive paint
- ✓ Indium foil

**Fasteners**

- Dental floss
- ✓ Clamps
- Screws/bolts
- ✓ VGE-7031 varnish
- ✓ Stycast® 2850 FT epoxy

**Heat sinking**

- ✓ Copper bobbins
- ✓ Metallized ceramic chips

**Other accessories**

- ✓ Vacuum feedthroughs
- ✓ Cartridge heaters

✓ Lake Shore stocks these accessories as a convenience to our customers

**Cryogenic accessories for installation****Cryogenic wire**

Cryogenic wire is different from normal wire due to its low thermal conductivity and high electrical resistivity. The most common types of cryogenic wire are phosphor bronze and manganin. Phosphor bronze is a nonmagnetic copper alloy. Manganin wire has a lower thermal conductivity (a factor of about  $\frac{1}{3}$ ) and higher resistivity compared to phosphor bronze wire. Both are readily available in small gauges ranging from 32 to 42 AWG. Either polyimide or polyvinyl formal (Formvar®) is used to insulate the wires. The polyimide is a resin with a 220 °C thermal rating. It has exceptional resistance to chemical solvents and toxic heat. It also is unaffected by exposure to varnish solvent. Formvar® is a vinyl acetate resin rated at 105 °C. It has excellent mechanical properties such as abrasion resistance and flexibility. The film will withstand excessive elongation without rupture when stressed during winding. Formvar® has a tendency to craze upon contact with solvents such as toluol, naptha, and xylol. It should be given an annealing preheat prior to varnish application. The Formvar® insulation can be removed mechanically or chemically during terminal preparation.

Phosphor bronze wire is readily available in multifilar form with 2 or 4 wires. In bifilar form, the wires are twisted to minimize noise pickup. In quadfilar form, the wires are either straight or 2 twisted pairs twisted together. The latter form is most useful for standard 4-lead measurements. The wires are bonded together for ease in heat sinking while the twisting helps minimize noise pickup. Straight Quad-Lead™ wire can be bonded together with the help of VGE-7031 varnish. The bonding agent is soluble in alcohol.

Other types of common cryogenic wires include nichrome wire, which has a very high electrical resistivity making it excellent for heater windings. Ultra miniature flexible coaxial cables with 304 stainless steel or copper conductors are available for providing shielded leads when necessary. For low resistance, heavy duty lead wires and multifilar silver-plated twisted copper wire are available. Constantan wire is another copper alloy having just a little more copper content than manganin. As such, its resistivity is a little lower, while its thermal conductivity is a little higher. Evanohm® wire is a very high resistivity wire (about 5 times the resistivity of nichrome) with very small temperature dependence. This wire is also excellent for heater windings.

**TIP: Making your own ribbon cable—ease of handling**

*Two nails should be hammered into a piece of wood at a distance of just over half the needed lead length. The wire is wrapped continuously from one nail to the other. With a rubber or plastic glove, apply a thin coating of VGE-7031 varnish along the entire length of the wires and allow to dry. Then the cable can be cut for full length. (Remember that the solvents in VGE-7031 varnish will attack Formvar® insulation.)*





### Solders and fluxes

The most common electrical connections are solder joints. There are a number of solder compounds available such as 60/40 tin/lead, silver, Wood's metal, cadmium/tin, and indium. They have varying melting points, and the melting points sometimes determine the upper temperature limit for a sensor. Care should be taken when using these solders, as the fumes are toxic. Also, many of these solders become superconducting at lower temperatures. The transition temperature should be checked if this could affect your experiment. (Read on to the fasteners section for more comments on solders.)

There are a number of fluxes that are used with these solders. Rosin Mildly Activated (RMA) soldering flux is an electronic grade rosin flux typically used for soldering wires to temperature sensors. Keep Clean flux is a mild acid flux used when RMA flux is not effective. It is strong enough to clean the oxidation off the surface and the solder to promote a good joint. It is very useful in situations where joints are repeatedly made and broken. Stay Clean flux is a corrosive acid flux used when neither of the above are useful. It is commonly used with stainless steel and platinum. Due to its highly corrosive nature, it must be cleaned off with methanol or water or it will continue to corrode the material. Stay Silv<sup>®</sup> flux is a high temperature flux for use with high temperature solders such as silver solder. It is not useful on aluminum, magnesium, or titanium.

It is often difficult to make electrical connection to many of the materials used for electrical leads in cryogenic applications. These lead materials include Kovar, copper, gold, phosphor bronze, manganin, constantan, platinum, stainless steel, and nichrome. Soldering these materials can be problematic. The small diameter wire complicates the problem by making it difficult to heat the wire uniformly, allowing the solder to flow. Choosing a proper flux and solder for the wire is crucial to making a reliable electrical connection with minimal effort.

Most of the sensors shipped by Lake Shore have undergone testing to ensure proper operation. Their electrical leads have been tinned. For these sensors, a standard electronic grade RMA flux is appropriate. This flux is also appropriate for Kovar, gold, and copper leads that have not been tinned. For other wire types, a more corrosive acid flux is needed. Stay Clean flux is recommended for untinned wire consisting of constantan, manganin, phosphor bronze, platinum, nichrome, or stainless steel.

**Note: Care must be taken to thoroughly clean the residual Stay Clean flux off with water or methanol after use to prevent further corrosion.**

Typically, standard 60/40 Sn/Pb solder can be used for applications ranging from 0.05 K to 350 K (liquidus point of 461 K and solidus point 456 K). This solder can be used with any of the above material types after tinning. If the application requires a higher temperature, then use 90/10 Pb/Sn solder (liquidus point of 575 K and solidus point 548 K). For very high temperatures up to 800 K, use Stay Silv<sup>®</sup> flux with cadmium-free silver solder (liquidus point of 922 K; solidus point of 891 K).

### Insulating materials

When installing electrical leads at low temperatures, it is important to know what insulation materials can be used. Insulating materials that work well at cryogenic temperatures include ceramics, temporary masking tape, polyester film tape, Kapton<sup>®</sup> film, Teflon<sup>®</sup> tape and tubing, G-10, Mylar<sup>®</sup>, epoxies, varnishes, cigarette paper (used under VGE-7031 varnish), and greases.

The most common varnish for cryogenic work is VGE-7031 varnish. It has good chemical resistance, bonds to a variety of materials and has a fast tack time. It may be air-dried or baked. VGE-7031 varnish is compatible with cotton, Dacron<sup>®</sup> polyester fiber, nylon, glass tapes, laminates, Mylar<sup>®</sup> polyester film, mica products, polyester products, vinyl products, wire enamels, paints, rayon, plastics, and metals. The solvents in VGE-7031 varnish will attack Formvar<sup>®</sup> insulation, causing it to craze, but in most cases this will not be a problem after drying thoroughly.

Stycast<sup>®</sup> 2850FT and GT are composed of a black epoxy resin, filled with silica powder to give them a lower thermal expansion coefficient. The FT is roughly matched to copper, while the GT is roughly matched to brass. The result is a material that is very strong, adheres well to metals, and tolerates brief exposure up to 200 °C for soldering. The drawbacks are that it is essentially unmachinable, has a non-negligible magnetic susceptibility and a temperature-dependent dielectric constant at low temperatures, and is somewhat permeable to helium at room temperature.

Another useful insulator is Kapton<sup>®</sup> tape. It is a polyimide tape with a thin coating of Teflon<sup>®</sup> FEP on either or both sides of the film to provide adhesion. The principal advantages of this severed tape insulation is its uniform, pinhole free covering and thermal stability for continuous use up to 240 °C. It has exceptional cut-through resistance under extreme temperature and pressure conditions. This Kapton<sup>®</sup> insulation offers excellent moisture protection and, because it is smooth and thin, has a space advantage over glass, Dacron<sup>®</sup> glass, paper, and fiber-over-film constructions. It is compatible with all standard varnishes, and is highly resistant to solvent attack.



### Conducting materials

Sometimes it is desired to make electrical contact between materials. The solders previously mentioned are electrically conducting, as are certain epoxies (silver-filled) and silver conductive paint.

### Fasteners

A variety of materials are suitable for fastening sensors at low temperatures. These include dental floss (Dacron® fiber), screws, bolts, pins, springs, tape, pastes, solders, epoxies, and varnishes. You must consider coefficients of linear expansion when deciding upon a mounting scheme. If linear expansion coefficients are too mismatched, mountings will simply come loose, or in the worst case, damage the mounting surface or the sensor. Expansion coefficients should never differ by more than a factor of 3 between two materials being bonded together. Greases such as Apiezon™ N grease, H grease, and Cry-Con® grease can be used to increase the surface area of contact between a sensor and the mounting surface. VGE-7031 varnish accomplishes the same purpose, as does Stycast® 2850. Mounting the sensor with Stycast® is more permanent.

If the Stycast® is being used with diodes, the user should be aware that stress on the diode package can cause piezoresistive shifts in the calibration curve. In extreme cases, (e.g., by using hard solder between the SD package and copper), the package can crack. The best joint in almost all cases is made by pure indium, which remains malleable at all temperatures. The exceptions are for service temperatures over 125 °C or where strength is paramount. Indium can also corrode rapidly in the presence of moisture under thermal cycling conditions.

#### TIP: Where to buy flux & solder

*RMA flux is available from most electronics supply stores as well as Kester Solder, 515 E. Touhy Avenue, Des Plaines, IL 60018*

*60/40 Sn/Pb solder is also available from most electronics supply stores both with and without RMA flux.*

*Stay Clean soldering flux, Stay Silv® white brazing flux, and cadmium-free silver solder are available from J. W. Harris Company, Inc., 10930 Deerfield Road, Cincinnati, OH 45242*

### SD package installation

Three aspects of using a cryogenic temperature sensor are critical to its optimum performance. The first involves the proper mounting of the sensor package; the second relates the proper joining of sensor lead wires and connecting wires; the final concern is the thermal anchoring of the lead wires. Although the sequence in which these areas should be addressed is not fixed, all elements covered under each aspect should be adhered to for maximum operating capabilities of the sensor.

#### Sensor mounting

1. The mounting area should be prepared and cleaned with a solvent such as acetone followed by an isopropyl alcohol rinse. Allow time for the solvents to evaporate before sensor mounting.
2. The list below provides brief instructions on mounting a sensor using a number of different methods. The constraints of your application should dictate the most appropriate mounting method to follow.

**Mechanical**—The preferred method for mechanically mounting an SD sensor is using the Lake Shore spring loaded clamp. This clamp should be ordered at the time the sensor is ordered (-CO suffix on sensor part number). The clamp holds the SD sensor in contact with the surface and also allows the sensor to be changed or replaced easily. A thin layer of Apiezon® N Grease (0.055 mm) or a flat 100% indium preform should be used between the sensor and mounting surface to enhance thermal contact. The spring keeps the sensor from getting crushed.

**Indium solder (100% In)**—A low wattage heat source should be used, as the sensor temperature must never exceed 200 °C (147 °C for Cernox®). The mounting surface and sensor should be tinned with a rosin flux (RMA is recommended) prior to mounting the sensor. A thin, uniform layer of indium solder should be the goal. Clean both the sensor and mounting surface of residual flux using rosin residue remover. Once the surface area is dry, reheat the mounting surface to the melting point of the solder (156 °C). Press the sensor into position and allow it to warm to the melting point of the solder. Remove the heat source and allow sufficient time for the solder to solidify (typically 2 to 3 seconds) before removing it.

**Apiezon® N grease**—This is best used as a thermal conductor when the sensor is mounted in a hole or recess, and when the sensor is intended to be removed. The sensor should be surrounded with thermal grease and placed into the mounting position. When the temperature is lowered, the thermal grease will harden, giving good support and thermal contact.

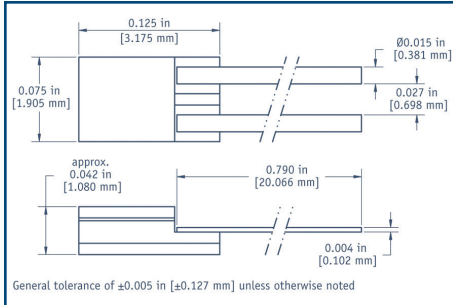

Figure 2 – SD Package

**VGE-7031 varnish**—Prepare varnish and apply a thin layer on the mounting surface. Press the sensor firmly against the varnish during curing to ensure a thin bond layer and good thermal contact. Varnish will air-dry in 5 to 10 minutes. Sufficient time must be allowed for the solvents in the varnish to evaporate. There is a small probability of ionic shunting across the sensor during the full cure period of the varnish (typically 12 to 24 hours).

**Stycast® 2850FT epoxy**—Prepare epoxy and apply a thin layer on the mounting surface. Press the sensor firmly into the epoxy during curing to assure a thin bond layer and good thermal contact. Epoxy will cure in 12 hours at 25 °C or in 2 hours at 66 °C.

**Note: When using an electrically conductive adhesive or solder, it is important that the excess does not “creep-up” the edges of the sensor or come in contact with the sensor leads. There is a thin braze joint around the sides of the SD package that is electrically connected to the sensing element. Contact to the sides with any electrically conductive material will cause a short.**

3. Follow manufacturer's instructions for adhesive curing schedule. Never heat the sensor above 200 °C (147 °C for Cernox®).

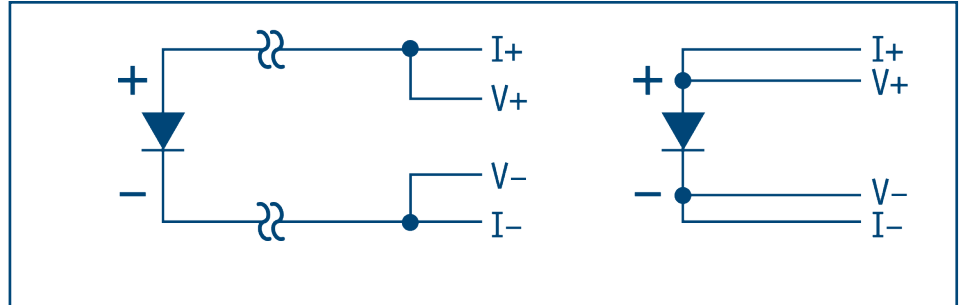

Figure 3 – 2-Lead versus 4-Lead Measurements

### Lead attachment

1. Although the SD sensor package (Figure 2) is a 2-lead device, measurements should preferably be made using a 4-wire configuration to avoid uncertainties associated with lead resistance.

**2-lead measurement scheme**—The leads used to measure the voltage are also the current carrying leads. The resulting voltage measured at the instrument is the sum of the temperature sensor voltage and the voltage drop across the 2 leads (see Figure 3).

**4-lead measurement scheme**—The current is confined to one pair of current leads with the sensor voltage measured across the voltage leads (see Figure 3).

2. Lead polarity: for the silicon diode and for the GaAlAs diode, when viewed with the base down (the base is the largest flat surface) and the leads toward the observer, the positive lead (anode) is on the right and the negative (cathode) is on the left. For Cernox® there is no polarity.
3. Strip the insulation from the connecting wires by scraping delicately with a razor blade, fine sand paper, or steel wool. Phosphor bronze or manganin wire, in sizes 32 or 36 AWG, is commonly used as the connecting lead wire. These wires have low thermal conductivity and high resistivity, which help minimize the heat flow through the leads. Typical wire insulation is polyvinyl formal (Formvar®) or polyimide (ML). Formvar® insulation has better mechanical properties such as abrasion resistance and flexibility. Polyimide insulation has better resistance to chemical solvents, heat, and radiation.
4. Prepare the connecting wire ends with an RMA (rosin mildly active) soldering flux, and tin them with a minimal amount of 60% Sn 40% Pb solder. Use a low wattage soldering iron which does not exceed 200 °C.
5. Clean off residual flux with rosin residue remover. The sensor leads can be prepared in an identical manner.
6. Join one sensor lead with two of the connector wires. Apply the soldering iron to the connector wire above the joint area until the solders melt, then remove the iron. Repeat for the other set of connector wires and the other sensor lead. Heat sinking the SD sensor with a flat jaw alligator clip is good practice to eliminate heat buildup at the sensor element.
7. Avoid putting stress on the device leads, and leave enough slack to allow for the thermal contractions that occur during cooling which could fracture a solder joint or lead. Some epoxies and shrink-tubing can put enough stress on lead wires to break them.



### Heat sinking/thermal anchoring

1. Since the area being measured is read through the base of the sensor, heat flow through the connecting leads creates less of an offset between the sensor chip and the true sample temperature than with other types of packages. However, thermal anchoring of the connecting wires is necessary to ensure that the sensor and the leads are at the same temperature as the sample.
2. Connecting wires should be thermally anchored at several temperatures between room temperature and cryogenic temperatures to guarantee that heat is not being conducted through the leads to the sensing element. Two different size copper bobbins are available from Lake Shore for heat sinking leads.
3. If connecting wires have a thin insulation such as Formvar<sup>®</sup> or polyimide, a simple thermal anchor can be made by winding the wires around a copper post, bobbin, or other thermal mass. A minimum of 5 wraps around the thermal mass should provide sufficient thermal anchoring, however, additional wraps are recommended for good measure if space permits. To maintain good electrical isolation over many thermal cycles, it is good practice to first varnish a single layer of cigarette paper to the anchored area then wrap the wire around the paper and bond in place with a thin layer of VGE-7031 varnish. Formvar<sup>®</sup> wiring insulation has a tendency to craze with the application of VGE varnish. If used, the wires cannot be disturbed until the varnish is fully cured and all solvents have evaporated (typically  $\geq 24$  hours).
4. A final thermal anchor at the sample itself is good practice to ensure thermal equilibrium between the sample and temperature sensor.

### CU, DI, CY, and CD package installation

Three aspects of using a cryogenic temperature sensor are critical to its optimum performance. The first involves the proper mounting of the sensor package; the second relates the proper joining of sensor lead wires and connecting wires; the final concern is the thermal anchoring of the lead wires. Although the sequence in which these areas should be addressed is not fixed, all elements covered under each aspect should be adhered to for maximum operating capabilities of the sensor.

#### Sensor mounting

The CU, DI, and CY packages (Figures 4 and 5) combine a standard SD sensor with a gold-plated copper mounting bobbin. The mounting bobbin of these packages each has a hole designed for mounting with a #4-40 screw. The CD package is shown in Figure 6.

1. A threaded hole in your mounting surface is necessary for mounting the sensor package. The hole in the sensor package will accommodate a #4-40 screw. A brass screw is recommended due to the thermal contractions/expansions of the final assembly.
2. The threaded hole and surrounding surface should be cleaned with a solvent such as acetone followed by an isopropyl alcohol rinse. Allow time for the solvents to evaporate before sensor mounting.
3. Apply a small amount of Apiezon<sup>®</sup> N grease to the threads of the screw. To ensure good thermal contact between the sensor and mounting surface, use an indium washer/preform or a thin layer of Apiezon<sup>®</sup> N grease between the mounting surface and the sensor package.  
Note: An overabundance of grease will increase the thermal barrier. Keep the thickness to 0.05 mm or less.
4. Insert screw through sensor mounting bobbin and tighten screw firmly enough to hold sensor in place. Avoid overtightening (torque of 3 to 5 in-oz [0.2 to 0.35 N-m] should be sufficient).

#### Lead attachment

The SD sensor has been attached to the mounting bobbin and encapsulated in Stycast<sup>®</sup> epoxy. The 0.92 m (36 in) Polyimide (ML) insulated sensor leads are 36 AWG phosphor bronze wire which are thermally anchored to the bobbin. Teflon<sup>®</sup> tubing is used as a strain relief to reinforce the leads at the bobbin assembly. The difference between the CU package and the DI package is the connecting lead configuration. Standard lead configuration for the CU is a 4-lead device [red (-), green (V-), black/dark blue (V+), clear (I+)] while standard lead configuration for the DI package is a 2-lead device [green = cathode (-), clear = anode (+)].



Figure 4—CU &amp; DI package

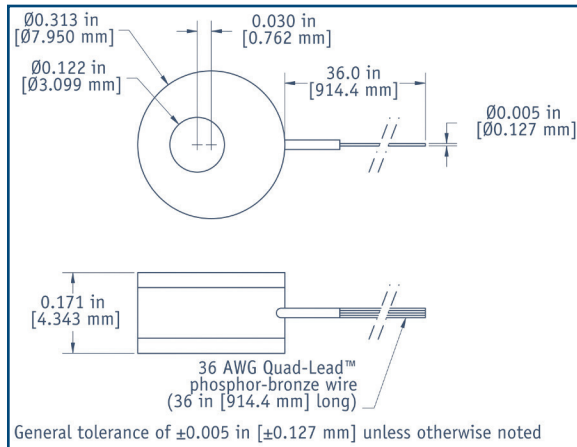

Figure 5—CY package

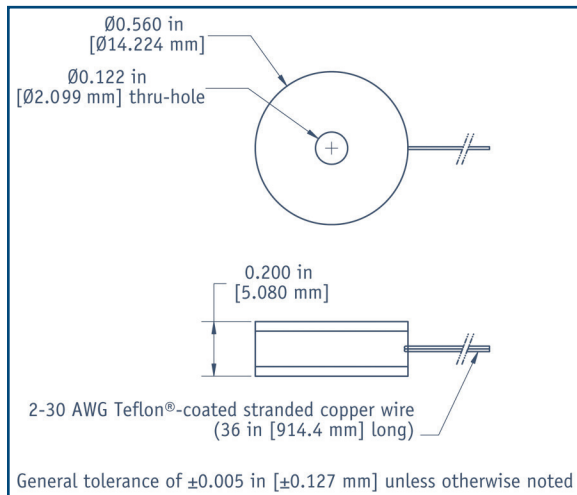
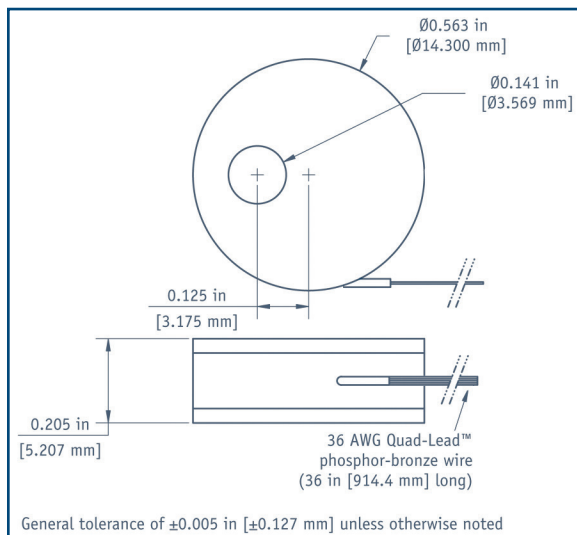

Figure 6—CD package

**DI package—2-lead measurement scheme**

The leads used to measure the voltage are also the current carrying leads. The resulting voltage measured at the instrument is the sum of the temperature sensor voltage and the voltage drop within the two current leads (see Figure 3).

**CU package—4-lead measurement scheme**

The current is confined to one pair of current leads with the sensor voltage measured across the voltage leads (see Figure 3).

Thirty-six inches of lead wire is attached during the production process. If additional connection wire is required, use the following instructions:

1. Prepare the sensor leads with an RMA (rosin mildly active) soldering flux, and tin them with a minimal amount of 60% Sn 40% Pb solder. Use a low wattage soldering iron that does not exceed 200 °C. Clean off residual flux with rosin residue remover.
2. Strip the insulation from the connecting wires by scraping delicately with a razor blade, fine sand paper, or steel wool. (Phosphor bronze or manganin wire, in sizes 32 or 36 AWG, is commonly used as the connecting lead wire. These wires have low thermal conductivity, which help minimize the heat flow through the leads. Typical wire insulation is Formvar® or Polyimide (ML). Formvar® insulation has better mechanical properties such as abrasion resistance and flexibility. Polyimide insulation has better resistance to chemical solvents and burnout.) Follow the same procedure as Step 1 for preparing connecting wires.
3. DI package—join one sensor lead with two of the connector wires. Apply the soldering iron above the joint area until the solders melt, then remove the iron immediately. Repeat for the other connecting wires and the other sensor lead. Insulate the joints appropriately.

CU package—identify lead polarities and apply the soldering iron above the joint area until the solders melt, then remove the iron immediately. Leave enough slack to allow for the thermal contractions that occur during cooling, which could fracture a solder joint or lead. Insulating the soldering joint is recommended to prevent shorts. Use heat shrink tubing. Teflon® and Kynar® shrink tubings are more resistant to cracking at low temperatures than polydelefin.



### Heat sinking/thermal anchoring

Depending on the application, sufficient heat sinking of the leads may already exist in the bobbin. Use the following procedure if additional heat sinking is recommended:

1. Connecting wires should be thermally anchored at several temperatures between room temperature and cryogenic temperatures to guarantee that heat is not being conducted through the leads to the sensing element.
2. A simple thermal anchor can be made by winding the wires around a copper post, bobbin, or other thermal mass. A minimum of 5 wraps around the thermal mass should provide sufficient thermal anchoring, however, additional wraps are recommended for good measure if space permits. To maintain good electrical isolation over many thermal cycles, it is good practice to first varnish a single layer of cigarette paper to the anchored area then wrap the wire around the paper and bond in place with a thin layer of VGE-7031 varnish. Formvar® wiring insulation has a tendency to craze with the application of VGE varnish. If used, the wires cannot be disturbed until the varnish is cured and all solvents have evaporated (typically  $\geq 24$  hours).

### Copper AA package

Three aspects of using a temperature sensor are critical to its optimum performance. The first involves the proper mounting of the sensor package; the second relates to the proper joining of sensor lead wires and connecting wires; the final concern is the thermal anchoring of the lead wires. Although the sequence in which these areas should be addressed is not fixed, all elements covered under each aspect should be adhered to for maximum operating capabilities of the sensor.

#### Sensor mounting

Shown in Figure 7, the copper AA package (or “can”) is designed for mounting in a 3.2 mm ( $\frac{1}{8}$  in) hole.

1. A hole should be drilled 3.2 mm ( $\frac{1}{8}$  in) diameter by 8.5 mm (0.335 in) deep minimum for the copper can.
2. Surface area should be cleaned with a solvent such as acetone followed by an isopropyl alcohol rinse. Allow time for the solvents to evaporate before sensor positioning.
3. A small amount of Apiezon® N grease should be applied around the mounting surface and the sensor to enhance thermal contact.
4. Position the copper can so that it is fully submerged in the mounting hole.

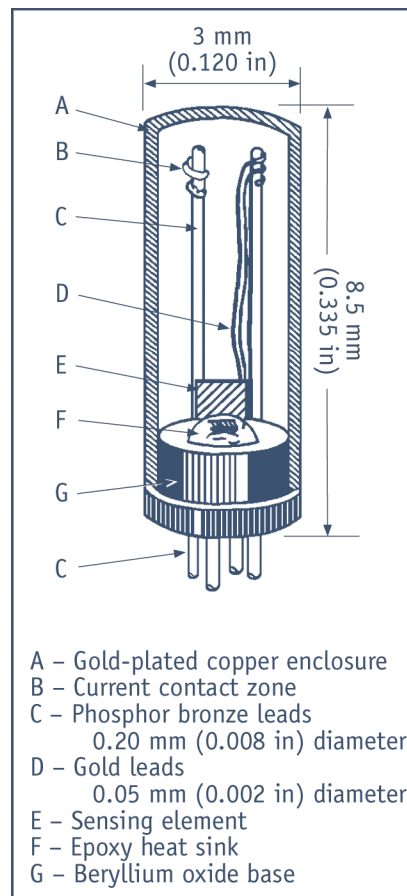

Figure 7—Copper AA package with Cernox® sensor shown. While internal connections are different for the other sensors, the overall package dimensions are the same.



### Lead configurations

Four leads are attached with strain relief at the sensor. For Cernox<sup>®</sup>, germanium, and rhodium-iron sensors, each lead is 32 AWG (0.20 mm diameter) phosphor bronze wire, insulated with heavy build polyimide to an overall diameter of 0.24 mm (0.0095 in), 150 mm (6 in) long. For Rox<sup>™</sup> sensors, each lead is 34 AWG (0.15 mm diameter) copper wire, insulated with heavy build polyurethane nylon to an overall diameter of 0.185 mm (0.0073 in), 15 cm (6 in) long. Thermal rating of the insulation is 220 °C. Leads are color-coded at the base of each sensor.

**Table 2—Key/color code**

	Rox <sup>™</sup> *	Cernox <sup>®</sup>	Germanium	Rhodium-iron
I+	—	White	White	White
V+		White	Yellow	White
I-	—	Black	Black	Black
V-		Black	Green	Black

\* The Rox<sup>™</sup> ruthenium oxide RTD uses the copper AA package but is a 2-lead only device. The leads have no specific polarity. While the Rox<sup>™</sup> is built as a 2-lead device, the sensor should be operated in a 4-lead measurement scheme to eliminate errors due to lead resistance, which can be significant.

### Extra lead attachment

If extra long leads are to be attached, then it is recommended that a 4-lead measurement scheme be used with this sensor. Attaching four connecting wires to the sensor leads is recommended. Refer to Table 2 to determine sensor lead polarity.

1. Prepare the sensor leads and connecting lead wires with a RMA (rosin mildly active) soldering flux, and tin them with a minimal amount of 60% Sn/40% Pb solder. Use a low wattage soldering iron that will not exceed 200 °C. Clean off residual flux with rosin residue remover. The sensing element inside the package should be protected from excessive heat by putting a heat sink clip over the package.
2. Strip connecting wire insulation by delicately scraping with a razor blade, fine sand paper, or steel wool. Phosphor bronze or manganin wire, in sizes 32 or 36 AWG, is commonly used as the connecting lead wire. These wires have low thermal conductivity, which helps minimize the heat flow through the leads. Typical wire insulation is polyvinyl formal (Formvar<sup>®</sup>) or Polyimide (ML). Formvar<sup>®</sup> insulation has better mechanical properties such as abrasion resistance and flexibility. Polyimide insulation has better resistance to chemical solvents and burnout.
3. Prepare the connecting wire ends with a RMA (rosin mildly active) soldering flux, tin them with a minimal amount of 60% Sn 40% Pb solder. Use a low wattage soldering iron that will not exceed 200 °C.
4. Clean off residual flux with rosin residue remover. The sensor lead can be prepared in an identical manner.
5. Attach one sensor lead with the connector wire and apply the soldering iron above the joint area until the solders melt, then remove the iron immediately. Repeat for the other set of connector wires and the other sensor lead.
6. Avoid putting stress on the device leads and leave enough slack to allow for the thermal contractions that occur during cooling that could fracture a solder joint or lead. This can be achieved with heat shrink tubing.



### Heat sinking/thermal anchoring

1. Since the heat flow through the connecting leads can create an offset between the sensor substrate and the true sample temperature, thermal anchoring of the connecting wires is necessary to assure that the sensor and the leads are at the same temperature as the sample.
2. Connecting wires should be thermally anchored at several temperatures between room temperature and cryogenic temperatures to guarantee that heat is not being conducted through the leads to the sensing element.
3. If the connecting leads have a thin insulation such as Formvar® or polyimide, a simple thermal anchor can be made by winding the wires around a copper post, bobbin, or other thermal mass. A minimum of 5 wraps around the thermal mass should provide enough of an anchor, however, additional wraps are recommended for good measure if space permits. To maintain good electrical isolation over many thermal cycles, it is good practice to first varnish a single layer of cigarette paper to the anchored area, then wrap the wire around the paper and bond in place with a thin layer of VGE-7031 varnish. Formvar® wiring insulation has a tendency to craze with the application of VGE varnish. Once VGE varnish is applied, the wires cannot be disturbed until all solvents have evaporated and the varnish has fully cured (typically 12 to 24 hours).
4. A final thermal anchor at the sample itself is a good practice to ensure thermal equilibrium between the sample and temperature sensor.

### Bare chip installation

#### General comments

All of the possible permutations for mounting the chips have not been thoroughly tested. Also, in order to avoid possible adverse effects on stability and thermal mass, heat capacity thermal response times, etc., chips also are not protected by a coating over the active film. The customer must therefore assume some risk of damaging the chips during installation. The sensor and contact films on the Cernox® chips, however, are refractory materials and difficult to scratch. The material presented below includes the best techniques we know to help assure the successful application of unencapsulated chips.

- a. Use good fine-point tweezers. Grasp the chip by the edges at one end (at a contact pad end, if possible). This way, if the tweezers should scrape across the chip, the resistor will not be damaged. Alternately, the wires may be grasped with fingers or tweezers. In the latter case, the operator must develop a very light touch so the wires are not cut or damaged.
- b. If it is necessary to apply pressure to the chip, do so with a cotton swab over the contact area, or with harder objects only outside the patterned area. Do not rub the chip.
- c. Some dirt particles will not hurt the sensor reading, but conducting particles and moisture may, especially if halogen (e.g., chlorine, etc.) contaminants are present. If it is deemed necessary to clean the chips, place a few into a watch glass and rinse with appropriate solvents. (A watch glass is used because it has a curved surface and the sensor will touch only at its corners. It also has a shallow sloped surface, and the rinse liquids can be easily decanted.) Finish with a rinse of pure isopropyl alcohol. Decant the liquid and dry under a light bulb ( $\approx 50$  °C). For chips with leads, hold the sensor by the leads and immerse it in isopropyl alcohol for a few seconds. CO<sub>2</sub> snow cleaning can also be very effective, as can ultraviolet/ozon treatments.

#### Attaching leads

There are several ways to apply electrical leads to the contact pads, which are gold over contact metal (not wetted easily with solder). In all cases, clamp the sensor chip by the edges and, if possible, do not rely on hand control to position and attach the wires. A clamp can be made from a small, smooth-jawed alligator clip (Figure 8) by cutting off the jaw on the side to which the wire is normally soldered and then fastening that side of the clip to a plate. Another method uses tape to hold the sensors (Figure 9). Kapton® tape and its adhesive will withstand epoxy cure temperatures (165 °C) and the adhesive will not come off on the chip. Do not use Scotch® tape.

The best way by far to connect the chip is to use a thermosonic gold ball bonder. The bonding is clean, uses no flux, and can be done at or near room temperature. The ball attachment at the pad also provides a robust way of making a flying lead that can be attached at the other end later (50  $\mu$ m diameter gold wire).





Another way is to use silver-loaded conducting epoxy. Make sure the wire and the pads are clean. Use a flexible wire, 40 AWG or smaller, so undue stress will not be applied to the pads. Use a needle to apply small amounts of epoxy to the pads and to the ceramic substrate as well. If the epoxy must be heated in order to cure, a temperature of up to 200 °C could be tolerated by the chip (not Cernox®). This should be done before calibrating, however, since the calibration may shift slightly (shift may amount to 1% of reading at temperatures above 50 K and 0.05% at 4.2 K and below).

### Mounting sensor chips

There are several means of attaching a chip to a substrate. It is possible for strain-induced shifts in calibration to occur. Therefore, keep in mind that the greater the expansion difference between the sensor substrate, the bonding substance and the mating piece, the more likely a strain-induced shift in the calibration may occur. If the joint is stable, this shift probably will be reproducible, and an in-situ calibration may remove the uncertainty. The only substance we have found capable of relieving stress during use is pure indium. This will only work with metallized substrates and in systems that can be heated if the joint is to be soldered.

If it is deemed advisable to use an indium solder joint for reasons of strain, and the mating piece cannot be soldered, a “buffer” layer of metallized BeO or sapphire can be used. Solder the chip to the buffer with indium, and use Stycast® 2850FT/catalyst 9 or equivalent epoxy to attach the buffer to the mating piece.

Stycast® 2850FT or another low expansion, nonconducting epoxy can be used for direct mounting as well. If epoxy is used to completely encapsulate the chip, stress-induced calibration shifts of up to 0.5 K can occur at lower temperatures.

If a greased mounting is desired (Apiezon® N or equivalent), the sensor could be inserted into a hole lined with cigarette paper or tied to a greased surface with thread or dental floss, with paper over it to avoid abrasion. The leads must be insulated with plastic sleeving, fiberglass sleeving, epoxy, or other technique.

VGE-7031 varnish is also a good mounting adhesive and is more easily removed than epoxy. It can be soaked into cigarette paper for a more reliable insulating layer for the leads. The substrate of the sensor is already insulating.

### Attaching cable wires to sensor leads

The lead wires on a chip sensor are necessarily small in diameter. 50 µm diameter gold wire has a break strength of about 25 g, and 62 µm (42 AWG) copper wire has a rated tensile strength of about 150 g, but the actual break strength is lower because the weak point is usually at the point of attachment or damage from handling (e.g., tweezer marks). The copper wire will only withstand 2 or 3 sharp 90° bends with a 10 g weight attached. The wire will also peel out of silver-loaded epoxy at a smaller force than the rated break strength. However, with reasonable care, loss from damaged leads is negligible.

### Soldering

Both gold and copper wires will dissolve in In and Pb/Sn solders, but gold dissolves much faster. Gold can be successfully soldered by using a temperature controlled iron set just above the solder’s melting point. The wire or other attachment point is tinned, and the gold wire stuck into the solder as the iron is removed. If the gold alloy is any length beyond the solder bead, the joint will be greatly weakened, but it is not difficult to repeatedly make successful joints.

Copper wire does not require the precautions above, but repeated soldering will gradually shorten the wire. Keep in mind that heat sinking may be necessary in some situations, but the joints on the chip, if any, will usually be well heat sunk through the chip.

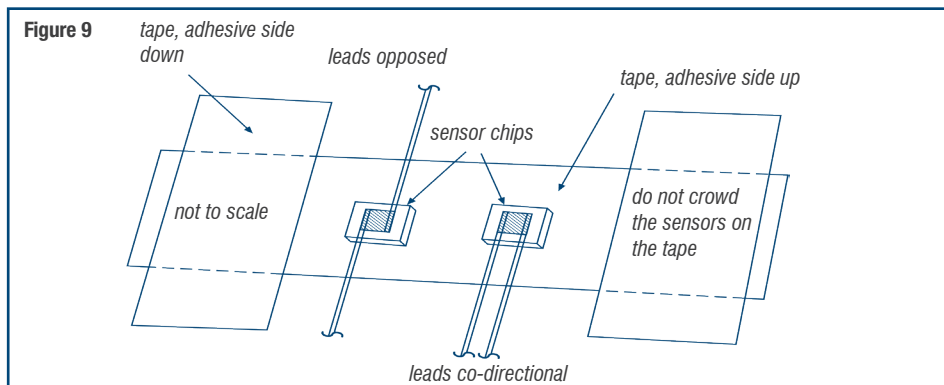
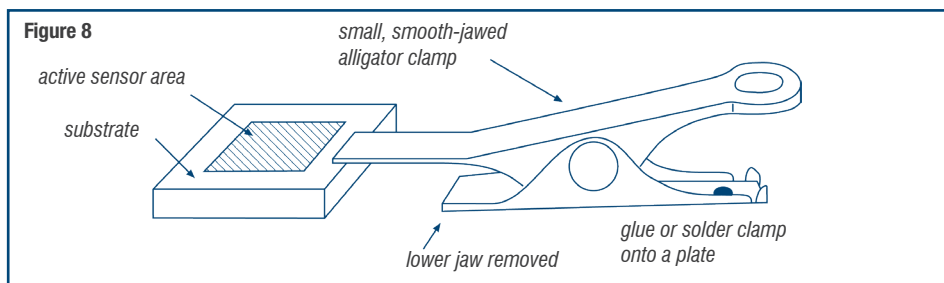



## Attachment

The two most important requirements are that the attachment points of the fine sensor wires should be immobile under all operating conditions, and the sensor leads should have some slack to take up contraction upon cooling. If the leads are connected to a cable, the cable should be attached so it cannot twist at the end. 4-wire (kelvin) cabling schemes down to the sensor leads are preferred for resistance sensors. The lower the resistance of the sensor, the more necessary this becomes.

The following sequence is usually the best:

1. Fix the end of the wire or cable in place, with the ends pretinned.
2. Apply an insulating layer on the mounting surface if it is a conductor. The uninsulated sensor leads can be kept separate using small Teflon® sleeving or by making channels out of the cigarette paper, Kapton® film, etc. used for the insulator. (See Figure 10.)
3. Mount the sensor as desired.
4. Adjust the sensor leads into contact with the proper cable wire and solder the joint. It is best to do this by pushing or training the leads into place. (See Figure 11.) Grasping the wire while trying to solder it is inviting wire damage. It is unnecessary to twist the sensor leads around the cable wires. Slack can be built into the leads by using two pairs of tweezers to put an “s-curve” into the wire before soldering.

## Cryogenic accessories

Recommended for proper installation and use of Lake Shore sensors—see Accessories section for more information

### Stycast® epoxy 2850FT

Permanent attachment, excellent low temperature properties, electrical insulator, low cure shrinkage

### Apiezon® N grease

Low viscosity, easy to use, solidifies at cryogenic temperatures, excellent lubricant

### VGE-7031 varnish

Nonpermanent attachment, excellent thermal conductor, easy to apply and remove

### Indium solder

99.99% pure, excellent electroplating material, foil form

### 90% Pb 10% Sn solder

Greater lead content, for higher temperature applications greater than 200 °C

### Soldering flux

Variety of types

### Phosphor bronze wire

Available in single, dual, and quad strands, no magnetic attraction, low thermal conduction

### Manganin wire

Low thermal conductivity, high resistivity, no magnetic attraction

### Heat sink bobbin

Gold-plated oxygen-free high-conductivity (OFHC) copper bobbins

Figure 10

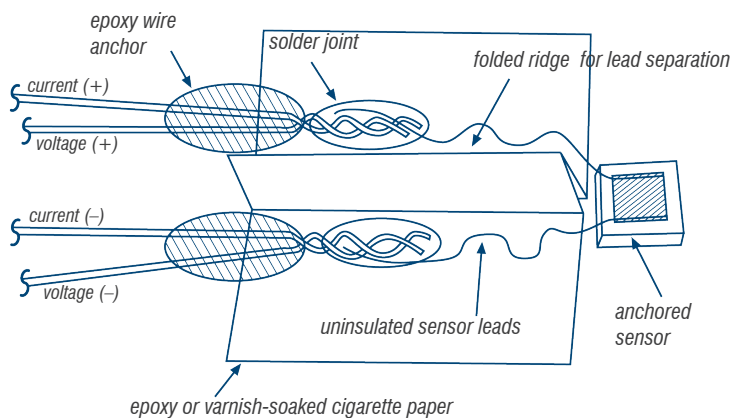
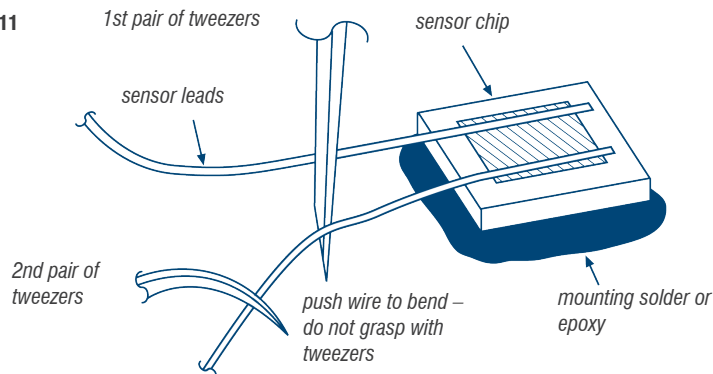

Figure 11





## Appendix D: Sensor Calibration Accuracies

### Understanding what's available:

#### Uncalibrated—Good

#### SoftCal™—Better

#### Calibrated—Best

The accuracy<sup>1</sup> of a sensor relates to how closely the measurement of resistance (or voltage) can be converted to temperature relative to the recognized international temperature scales (ITS-90 and PLTS-2000). Understanding how the accuracy of temperature sensors is specified begins with the definition of the response curve (e.g., voltage vs. temperature, resistance vs. temperature) for a particular sensor.

Temperature sensors either follow a known standard response within a given tolerance, or they must be calibrated against known standards. Details on calibration procedure are defined in this section. More information on the measurement system and uncertainty analysis is found in Appendix E: Temperature Measurement System.

It is convenient to have temperature sensors that match a standard curve and do not need an individual calibration. Such sensors are interchangeable. Interchangeable sensors follow the same response curve to within a given accuracy and can be interchanged routinely with one another.

Some cryogenic temperature sensors exist currently which are interchangeable within several tolerance bands. The Lake Shore DT-670 series silicon diodes are one example. These conform to five defined accuracy bands about a single curve (Curve 670) and can be ordered by simply specifying the tolerance band required for the experimental accuracy required. In this case, individual calibrations are not performed. However, if increased accuracy is required, full calibration over a specified range may be selected. This provides a fully characterized sensor that can be relied upon for much more accurate measurements, at the cost of being considered “interchangeable” with other sensors from that product line.

In addition to diodes, both platinum and ruthenium oxide sensors also follow a standard curve of resistance versus temperature. Platinum sensors follow an industry standard curve (IEC 751). Lake Shore offers platinum available in Class B tolerance band. If greater temperature accuracy is required, these sensors can be individually calibrated or a SoftCal™ can be utilized to increase the accuracy of the temperature measurement.

Ruthenium oxide RTDs are also interchangeable. Like silicon diodes, they are interchangeable within a manufacturer lot. Two tolerance bands for ruthenium oxide are defined by Lake Shore.

Table 1, Table 2, and Table 5 summarize Lake Shore temperature sensor accuracies. They are categorized into Good, Better, and Best for each sensor type. The following pages explain the advantages of investing in SoftCal™ or a full calibration from Lake Shore to obtain improved accuracy.

<b>Good</b>	Uncalibrated	<ul style="list-style-type: none"> <li>■ Silicon diodes follow standard curve</li> <li>■ Platinum resistors follow standard curve</li> <li>■ Interchangeable Rox™ resistors follow standard curve</li> <li>■ Cernox® and germanium sensors can be purchased uncalibrated but must be calibrated by the customer</li> </ul>
<b>Better</b>	SoftCal™	<ul style="list-style-type: none"> <li>■ An abbreviated calibration (2-point: 77 K and 305 K; or 3-point: 77 K, 305 K, and 480 K) which is available for platinum sensors</li> </ul>
<b>Best</b>	Calibration	<ul style="list-style-type: none"> <li>■ All sensors can be calibrated in the various pre-defined temperature ranges. Lake Shore has defined calibration ranges available for each sensor type. The digits represent the lower range in kelvin, and the letter corresponds to high temperature limit, where:  A = 6 K    B = 40 K    D = 100 K    L = 325 K    M = 420 K    H = 500 K    J = 800 K  For example: The calibration range “1.4L” would result in a sensor characterized from 1.4 K to 325 K</li> </ul>

<sup>1</sup> The use of the terms accuracy and uncertainty throughout this catalog are used in the more general and conventional sense as opposed to following the strict metrological definitions. For more information, see Appendix B: Accuracy versus Uncertainty.



### Uncalibrated—Good

With the purchase of an uncalibrated sensor you will receive:

#### Silicon diodes

- Curve 670 data (DT-670)
- Installation instructions

#### Platinum

- Standard IEC-751 data
- Installation instructions

#### Ruthenium oxide

- Curve data (102, 103, or 202)
- Installation instructions

#### Thermocouple

- Reference data

#### Cernox®, germanium, capacitance

- Installation instructions

**Table 1—Uncalibrated sensors: typical accuracy (interchangeability)**

	Temperature														
	0.05 K	0.5 K	1.4 K	2 K	4.2 K	10 K	20 K	25 K	40 K	70 K	100 K	305 K	400 K	500 K	670 K
<b>Silicon diode</b>															
DT-470-SD, Band 11	—	—	—	±0.25 K	±0.25 K	±0.25 K	±0.25 K	±0.25 K	±0.25 K	±0.25 K	±0.25 K	±0.5 K	±1.0 K	±1.0 K	—
DT-470-SD, Band 11A	—	—	—	±0.25 K	±0.25 K	±0.25 K	±0.25 K	±0.25 K	±0.25 K	±0.25 K	±0.25 K	±1% of temp	±1% of temp	±1% of temp	—
DT-470-SD, Band 12	—	—	—	±0.5 K	±0.5 K	±0.5 K	±0.5 K	±0.5 K	±0.5 K	±0.5 K	±0.5 K	±1.0 K	±2.0 K	±2.0 K	—
DT-470-SD, Band 12A	—	—	—	±0.5 K	±0.5 K	±0.5 K	±0.5 K	±0.5 K	±0.5 K	±0.5 K	±0.5 K	±1% of temp	±1% of temp	±1% of temp	—
DT-470-SD, Band 13	—	—	—	±1.0 K	±1.0 K	±1.0 K	±1.0 K	±1.0 K	±1.0 K	±1.0 K	±1.0 K	±1% of temp	±1% of temp	±1% of temp	—
DT-471-SD	—	—	—	—	—	±1.5 K	±1.5 K	±1.5 K	±1.5 K	±1.5 K	±1.5 K	±1.5% of temp	±1.5% of temp	±1.5% of temp	—
DT-414	—	—	—	±1.5 K	±1.5 K	±1.5 K	±1.5 K	±1.5 K	±1.5 K	±1.5 K	±1.5 K	±1.5% of temp	—	—	—
DT-421	—	—	—	—	—	—	±2.5 K	±2.5 K	±2.5 K	±2.5 K	±2.5 K	±1.5% of temp	—	—	—
DT-670-SD, Band A	—	—	—	±0.25 K	±0.25 K	±0.25 K	±0.25 K	±0.25 K	±0.25 K	±0.25 K	±0.25 K	±0.5 K	±0.5 K	±0.5 K	—
DT-670-SD, Band B	—	—	—	±0.5 K	±0.5 K	±0.5 K	±0.5 K	±0.5 K	±0.5 K	±0.5 K	±0.5 K	±0.5 K	±0.33% of temp	±0.33% of temp	—
DT-670-SD, Band C	—	—	—	±1.0 K	±1.0 K	±1.0 K	±1.0 K	±1.0 K	±1.0 K	±1.0 K	±1.0 K	±1.0 K	±0.5% of temp	±0.5% of temp	—
DT-670-SD, Band D	—	—	—	—	—	—	—	±0.25 K	±0.25 K	±0.25 K	±0.25 K	±0.50 K	±0.2% of temp	±0.2% of temp	—
DT-670-SD, Band E	—	—	—	—	—	—	—	±0.25 K	±0.25 K	±0.25 K	±0.25 K	±0.25% of temp	±0.25% of temp	±0.25% of temp	—
<b>Platinum</b>															
PT-102	—	—	—	—	—	—	—	—	—	±1.3 K	±1.2 K	±0.5 K	±0.9 K	±1.4 K	±2.3 K
PT-103	—	—	—	—	—	—	—	—	—	±1.3 K	±1.2 K	±0.5 K	±0.9 K	±1.4 K	±2.3 K
PT-111	—	—	—	—	—	—	—	—	—	±1.3 K	±1.2 K	±0.5 K	±0.9 K	±1.4 K	±2.3 K
<b>Rox™</b>															
RX-102A-AA	±10 mK	±25 mK	±50 mK	±75 mK	±125 mK	±300 mK	±1.25 K	±1.5 K	±4.0 K	—	—	—	—	—	—
RX-102A-AA-M	±5 mK	±20 mK	±25 mK	±40 mK	±75 mK	±200 mK	±500 mK	±750 mK	±1.5 K	—	—	—	—	—	—
RX-202A-AA	±15 mK	±30 mK	±100 mK	±125 mK	±250 mK	±1 K	±2.5 K	±3 K	±5.0 K	—	—	—	—	—	—
RX-202A-AA-M	±10 mK	±25 mK	±50 mK	±75 mK	±150 mK	±500 mK	±1.0 K	±1.5 K	±2.0 K	—	—	—	—	—	—
RX-103A-AA	—	—	±150 mK	±180 mK	±400 mK	±1 K	±2.0 K	±2.5 K	±4.0 K	—	—	—	—	—	—
RX-103A-AA-M	—	—	±50 mK	±75 mK	±100 mK	±300 mK	±700 mK	±1 K	±1.5 K	—	—	—	—	—	—



## SoftCal™—Better

SoftCal™ is only available with platinum resistors.

With the purchase of SoftCal™ you will receive:

- Interpolation table and breakpoint interpolation table
- 2-point calibration report (thermal cycling data at LN<sub>2</sub> and room temperature K) OR
- 3-point calibration report (thermal cycling data at LHe, LN<sub>2</sub>, and either 305 K or 480 K)

The temperature characteristics of Lake Shore temperature sensors are extremely predictable, and exhibit excellent uniformity from device to device. The SoftCal™ feature (sensor specific interpolation/extrapolation techniques) allows an abbreviated calibration, based on two or three calibration points, to generate a resistance versus temperature or voltage versus temperature curve over the useful range of selected sensors with remarkable accuracy. In the case of

the Lake Shore platinum resistance sensors, the SoftCal™ procedure makes small adjustments to the IEC-751 curve so that the resulting curve matches the resistance versus temperature characteristic of the individual sensor more closely. SoftCal™ provides the means to generate accurate, inexpensive calibrations for selected Lake Shore sensors to use with either Lake Shore temperature controllers and monitors or the customer's own readout electronics.

**Table 2—SoftCal™ (2- and 3-point soft calibration sensors): typical accuracy**

	70 K	305 K	400 K	475 K	500 K	670 K
<b>Platinum</b>						
PT-102-2S <sup>2</sup>	±0.25 K	±0.25 K	±0.9 K	±1.3 K	±1.4 K	±2.3 K
PT-103-2S <sup>2</sup>	±0.25 K	±0.25 K	±0.9 K	±1.3 K	±1.4 K	±2.3 K
PT-111-2S <sup>2</sup>	±0.25 K	±0.25 K	±0.9 K	±1.3 K	±1.4 K	±2.3 K
PT-102-3S <sup>3</sup>	±0.25 K	±0.25 K	±0.25 K	±0.25 K	±1.4 K	±2.3 K
PT-103-3S <sup>3</sup>	±0.25 K	±0.25 K	±0.25 K	±0.25 K	±1.4 K	±2.3 K
PT-111-3S <sup>3</sup>	±0.25 K	±0.25 K	±0.25 K	±0.25 K	±1.4 K	±2.3 K

<sup>2</sup> 2S (2-point at 77 K and 305 K)

<sup>3</sup> 3S (3-point at 77 K, 305 K, and 480 K)



## Calibrated—Best

Lake Shore calibrations include the following:

- Certificate of calibration
- Calibration data plot
- Calibration test data
- Polynomial fit equation and fit comparisons (temperature as a function of resistance or voltage)
- Interpolation table (resistance or voltage as a function of temperature)
- Breakpoint interpolation table
- Instrument breakpoint table

Lake Shore provides precision temperature calibrations for all sensor types, and Lake Shore calibrations are traceable to internationally recognized temperature scales.

Above 0.65 K, calibrations are based on the International Temperature Scale of 1990 (ITS-90). The ITS-90 scale became the official international temperature scale on January 1, 1990; it supersedes the International Practical Temperature Scale of 1968 (IPTS-68) and the 1976 Provisional Temperature Scale (EPT-76). Internally, this scale is maintained on a set of germanium, rhodium-iron, and platinum standards grade secondary thermometers calibrated at the U.S. National Institute of Standards and Technology (NIST) or Great Britain's National Physical Laboratory (NPL), or another recognized national metrology laboratory. Working standard thermometers are calibrated against, and routinely intercompared with, these secondary standards.

For temperatures below 0.65 K, Lake Shore calibrations are based on the Provisional Low Temperature Scale of 2000 (PLTS 2000) adopted by the Comité International des Poids et Mesures in October 2000. Internally, this scale is maintained on a set of germanium and rhodium-iron resistance thermometers calibrated at the U.S. National Institute of Standards and Technology, Great Britain's National Physical Laboratory, or Germany's Physikalisch-Technische Bundesanstalt (PTB). Working standard thermometers are calibrated against, and routinely intercompared with, these secondary standards along with a nuclear orientation thermometer and superconducting fixed points sets.

### Calibration method

Lake Shore performs comparison calibrations measuring the resistance or forward voltage of both the sensor under test and the working standard thermometer. All measurements are performed in a four-lead fashion to eliminate lead resistance.

The sensors to be calibrated are mounted, along with appropriate known standards, in a copper block designed to accommodate a variety of sensor styles. This block is enclosed within a quasi-adiabatic copper radiation shield, which, in turn, is thermally isolated within an outer vacuum jacket.

Constant temperature of the block is achieved by an appropriately mounted heater and precision temperature controller. The electrical, mechanical, and thermal designs of the calibration probe provide extremely stable and uniform temperatures within the copper block.

The calibration process above 4.2 K is computer controlled and the calibration data collected automatically. Data points are usually not at integer temperatures since the primary concern is temperature stability near a data point rather than the specific value. The precise temperature for each data point is subsequently determined. The typical number of data points collected is listed in Table 4 (page 186).

Calibration data is provided for each calibration, together with a calibration data plot and polynomial fits to that raw data, along with a computer generated smoothed interpolation table which is listed as a function of temperature. For resistance sensors, the raw data is given as temperature (T) and resistance (R); the interpolation table shows T, R,  $dR/dT$  and dimensionless sensitivity  $d(\log R)/d(\log T)$ . For diode sensors, the raw data is given as forward voltage (V) and temperature (T), and the interpolation table presents T, V, and  $dV/dT$ .

The specific techniques for generating and controlling calibration temperatures vary, depending on the temperature involved.

Calibrations performed over a wide temperature span frequently entail the consecutive use of a variety of procedures and equipment. In these cases, data points are routinely overlapped to assure integrity of the calibration. The sections that follow describe the specific techniques used for the various temperature ranges.

### Calibration method—1.2 K to 330 K

Temperatures from 1.2 K to 4.2 K are achieved by filling a He-4 subpot attached to the copper sensor block and pumping on the subpot through a vacuum regulator valve. Temperatures above 4.2 K are achieved by applying controlled power to a heater while the entire probe assembly remains immersed in liquid helium. In either case, the sensors themselves are maintained in a vacuum.



Extreme care is taken to ensure that the sensor block is thermally stable before calibration data is collected. The computer examines successive and interposed measurements of both the known standards and the sensors being calibrated at each data point to verify temperature stability.

Once temperature has stabilized, an appropriate DC excitation current is applied to the thermometer, and the resulting voltage is measured. In the case of resistance sensors, currents from 0.01 mA to 5 mA are selected as required. Sensor voltage is maintained between 1 mV and 3 mV for Cernox<sup>®</sup>, carbon-glass, germanium, and Rox<sup>™</sup> elements up to 300 k $\Omega$ . Higher resistances are measured using a fixed current of 0.01 mA. Sensor power is held between 1 mW and 10 mW for platinum and rhodium-iron resistors.

For resistors, successive voltage readings taken with the current applied in opposite polarities are averaged together to eliminate thermal EMFs from the data. The resistance of the sensing element is determined and reported to five significant figures at each temperature.

Diode thermometers are normally excited with a 10  $\mu$ A current ( $\pm 0.1\%$ ) and the resulting forward voltage reported to five significant figures.

#### Calibration method—below 1.2 K

Calibration temperatures below 1.2 K are produced in a dilution refrigerator. Techniques similar to those for higher temperatures are followed to ensure reliable calibration data. The need for increased care at these lower temperatures, however, requires greater involvement on the part of a skilled system technician and less reliance on automation.

Sensors are measured with a Lake Shore Model 370 AC resistance bridge operated at 13.7 Hz. Germanium and Rox<sup>™</sup> sensors are maintained at a nominal excitation voltage of 20  $\mu$ V RMS (0.05 K to 0.1 K) or 63  $\mu$ V RMS (0.1 K to 1.2 K). Cernox<sup>®</sup> sensors are maintained at a nominal excitation voltage of 20  $\mu$ V RMS from 0.1 K to 0.5 K and 63  $\mu$ V RMS from (0.5 K to 1.2 K).

#### Accuracy considerations

The uncertainty associated with a sensor calibration is the net result of each step in the calibration process. A temperature scale disseminated by national standards laboratories is transferred to secondary thermometers maintained by Lake Shore. Those thermometers are used to calibrate in-house working standard thermometers which are then used to calibrate commercial thermometers. Each step introduces an uncertainty that depends on the instrumentation used in the calibration and the specific temperature dependent characteristics of the sensor type calibrated. Other considerations such as calibration block uniformity and stability must also be accounted for. As a result, the calibration accuracy varies with both temperature range and sensor type.

In practice, however, the uncertainty of subsequent measurements performed with a calibrated sensor should include an additional uncertainty related to the short-term reproducibility of the sensor.

A summary of total calibration uncertainty for selected Lake Shore sensors at specific temperatures is given in Table 5. Errors in each case are expressed in millikelvin deviation from ITS-90 or PLTS-2000. The values in this table reflect the combination of all calibration uncertainties, and the short-term reproducibility upon temperature cycling. It should be noted that at a given temperature, uncertainties are highest for sensors with lowest normalized sensitivity [(1/R)(dR/dT) or (T/R)(dR/dT)] due to the low signal-to-noise ratio.

Lake Shore's calibration facility and procedures for diode and resistance sensor calibrations are traceable to recognized national metrology laboratories and are in compliance with ISO 9001. See page 189 regarding recalibration information.



### Lake Shore calibrations include:

**1. Certificate of calibration**—This states the traceability of the calibrations performed by Lake Shore to international temperature scales and standards.

**2. Calibration data**—The measured test data (resistance or forward voltage) is plotted as a function of the temperature. A straight-line interpolation is shown between the data points as a visual aid to the behavior of the sensor.

**3. Calibration data plot**—This table contains the actual calibration data recorded during the calibration of the temperature sensor. The indicated temperatures are those measured using the standard thermometers maintained by Lake Shore, while the voltage or resistance values are the measurements recorded on the device being calibrated.

**Table 3—Number of calibration data points**

Range (K)	Typical number of data points	Interpolation calibration printout interval
0.050 to 0.100	6	0.005
0.100 to 0.300	9	0.010
0.300 to 0.500	5	0.020
0.500 to 1.00	7	0.050
1.00 to 2.00	18	0.10
2.00 to 5.00		0.20
5.00 to 10.0	40	0.50
10.0 to 30.0		1.0
30.0 to 40.0		2.0
40 to 100		5.0
100 to 300	28	5.0
300 to 380		5.0
340 to 480 (silicon diodes)	10	5.0
340 to 480 platinum (400 K upper limit)	15	5.0
480 to 800 platinum sensors only	2	5

**4. Curve fit**—A curve fit is given for each sensor, allowing temperature to be calculated from the measurement of the forward voltage (diodes) or the resistance. One of two curve fit types are used: the first curve fit type is a polynomial equation based on the Chebychev polynomials; the second curve fit type is based on a cubic spline routine. Cubic spline routines are preferred when fitting a rapidly varying function or when smoothing is not desired. In general, the differences between the spline technique and the polynomial fits will be considerably less than the measurement uncertainties.

### Chebychev polynomial fits

A polynomial equation based on the Chebychev polynomials has the form

$$T(X) = \sum a_n t_n(X) \quad \text{Eqn. 1}$$

where  $T(X)$  represents the temperature in kelvin,  $t_n(X)$  is a Chebychev polynomial,  $a_n$  represents the Chebychev coefficient, and the summation is performed from 0 to the order of the fit. The parameter  $X$  is a normalized variable given by

$$X = ((Z-Z_L)-(Z_U-Z))/(Z_U-Z_L). \quad \text{Eqn. 2}$$

For diodes,  $Z$  is simply the voltage  $V$ . For resistors,  $Z$  is either the resistance  $R$  or  $Z = \log_{10}(R)$  depending on the behavior of the resistance with temperature.  $Z_L$  and  $Z_U$  designate the lower and upper limit of the variable  $Z$  over the fit range.

The Chebychev polynomials can be generated from the recursion relation

$$t_{n+1}(X) = 2Xt_n(X) - t_{n-1}(X) \quad \text{Eqn. 3}$$

$$\text{where } t_0(X) = 1, t_1(X) = X$$

Alternately, these polynomials are given by

$$t_n(X) = \cos [n \cdot \arccos(X)]. \quad \text{Eqn. 4}$$

All the necessary parameters for using equations 1 through 4 to calculate temperatures from either resistance or voltage are given in the calibration report. This includes the Chebychev coefficients,  $Z_L$  and  $Z_U$ , and also the definition of  $Z$ . Depending on the sensor being calibrated and the calibration range, several different fit ranges may be required to span the full temperature range adequately.

The use of Chebychev polynomials is no more complicated than the use of the regular power series, and they offer significant advantages in the actual fitting process. The first step is to transform the measured variable, either  $R$  or  $V$ , into the normalized variable using equation 2. Equation 1 is then used in combination with equation 3 or 4 to calculate the temperature.

An interesting and useful property of the Chebychev fits is evident in the form of the Chebychev polynomial given in equation 4. The cosine function requires that  $[t_n(X)] \leq 1$ , so no term in equation 1 will be greater than the absolute value of the coefficient. This property makes it easy to determine the contribution of each term to the temperature calculation and where to truncate the series if the full accuracy of the fit is not required.



**Table 4—Calibrated sensors: typical accuracy<sup>4</sup>**

	Temperature												
	0.05 K	0.1 K	0.3 K	0.5 K	1 K	1.4 K	4.2 K	10 K	20 K	77 K	300 K	400 K	500 K
<b>Silicon diode</b>													
DT-670	—	—	—	—	—	±21 mK	±12 mK	±12 mK	±14 mK	±34 mK	±35 mK	±50 mK	±54 mK
<b>Cernox®</b>													
CX-1010	—	±4 mK	±4 mK	±4 mK	±5 mK	±5 mK	±5 mK	±6 mK	±11 mK	±25 mK	±79 mK	±125 mK	—
CX-1030	—	—	±4 mK	±4 mK	±5 mK	±5 mK	±5 mK	±6 mK	±9 mK	±25 mK	±75 mK	±96 mK	—
CX-1050	—	—	—	—	—	±5 mK	±5 mK	±6 mK	±9 mK	±16 mK	±49 mK	±77 mK	—
CX-1070	—	—	—	—	—	—	±5 mK	±6 mK	±9 mK	±16 mK	±48 mK	±75 mK	—
CX-1080	—	—	—	—	—	—	—	—	±9 mK	±16 mK	±40 mK	±65 mK	—
<b>Rox™</b>													
RX-102A/103A/202A	±4 mK	±4 mK	±4 mK	±4 mK	±5 mK	±5 mK	±17 mK	±22 mK	±38 mK	—	—	—	—
<b>Platinum</b>													
PT-103/111	—	—	—	—	—	—	—	—	±10 mK	±12 mK	±26 mK	±48 mK	±58 mK
<b>Germanium</b>													
GR-50/300/1400	±5 mK	±5 mK	±5 mK	±5 mK	±6 mK	±6 mK	±6 mK	±4 mK	±8 mK	±25 mK	—	—	—

<sup>4</sup>All accuracies are:  $2\sigma$  figures;  $[(\text{calibration uncertainty})^2 + (\text{reproducibility})^2]^{0.5}$

The Chebychev polynomial fit is a smoothing fit and often yields a better representation of the calibration, as it can eliminate some random errors. Along with each set of Chebychev coefficients, a deviation table is given to show how well the polynomial fits the measured test data. This table gives the measured resistance or voltage, the measured temperature, and the temperature calculated from the fit equation. The last column gives the difference in millikelvin (0.001 K) between the measured value and the calculated value. A root mean square (RMS) deviation is given as an indication of the overall quality of the fit and as an indication of the accuracy with which the equation represents the calibration data. Chebychev polynomial fits are provided for all resistance temperature sensor calibrations.

A polynomial fit to the as-measured data is an additional source of uncertainty when using the sensor. In the polynomials provided with this set of calibration data, the standard deviation of the fit can be used as an estimate of this additional temperature uncertainty. The standard deviation of fit is determined from the following equation:

$$\sigma_{fit}^2 = \frac{\sum_{i=1}^N (T_i - T_{i\text{calc}})^2}{N - n} = \frac{N}{N - n} (\Delta T_{RMS})^2$$

where

$\sigma_{fit}$  = standard deviation of the fit

$T_i$  = measured temperature for point  $i$

$T_{i\text{calc}}$  = the temperature calculated from the polynomial equation for point  $i$

$N$  = number of data points in fit range

$n$  = number of fit coefficients

$\Delta T_{RMS}$  = root mean square deviation of fit

A value of  $\Delta T_{RMS}$  is given for each range of fit.



### Cubic spline fit

Some device types (e.g., GaAIAs diode thermometers) have either a fine structure that is undesirably smoothed by a Chebychev polynomial fit or else a rapidly varying response with temperature. For these devices, a cubic spline fit is provided. A cubic spline fit creates a cubic equation for each interval between calibration points. At each calibration point, the method requires that the cubic equations on either side of the calibration point match in value, first derivative (slope), and second derivative (curvature) at the calibration point. For this fit method, a table is provided listing temperature (T), forward voltage (V), and curvature (C) for each calibration point. In use, the voltage V is measured at the unknown temperature T. Using the provided table, the bracketing calibration points V(k) and V(k+1) are determined and the following quantities are defined:

$$dV=V(k+1)-V(k), dT=T(k+1)-T(k), dx=V-V(k), \quad \text{Eqn. 6}$$

$$\text{from which } S(0)=T(k), \quad \text{Eqn. 7}$$

$$S(1)=(dT/dV)-dV \cdot (2 \cdot C(k)+C(k+1))/6, \quad \text{Eqn. 8}$$

$$S(2)=C(k)/2, \text{ and} \quad \text{Eqn. 9}$$

$$S(3)=(C(k+1)-C(k))/(6 \cdot dV) \text{ are derived.} \quad \text{Eqn. 10}$$

Finally, the temperature is calculated as

$$T=S(0)+S(1) \cdot dx+S(2) \cdot dx^2+S(3) \cdot dx^3. \quad \text{Eqn. 11}$$

A major difference between the Chebychev polynomial fit and the cubic spline fit is that the cubic spline fit provides no smoothing. The curve fit produced by this method passes through each calibration point exactly, so there are no error terms to report.

**5. Interpolation table**—A complete interpolation table is provided over the calibration range of the sensor. This table lists the temperature, the resistance (resistance sensors) or voltage (diode sensors), the sensitivity (dR/dT or dV/dT), and, in the case of resistors, a normalized dimensionless sensitivity  $[d(\log R)/d(\log T) = (T/R) \cdot (dR/dT)]$ . The interpolation table lists resistance or voltage as a function of temperature, which is the reverse of the curve fit, which gives temperature as a function of sensor units. A cubic spline routine is used to calculate the resistance or voltage at a predetermined set of temperatures. For resistors, the interpolation table is calculated from the smoothed data produced by the Chebychev curve fit. For diodes, however, the interpolation table is calculated from the raw data in order to maintain the fine structure of the sensors' temperature response. Consequently, slight differences between the polynomial equations and the interpolation table are expected. These differences may be on the order of the RMS deviations for the polynomial fits. For resistors, these differences are typically about one tenth the calibration uncertainty. For diodes, the differences may be on the order of the calibration uncertainty in the regions of high curvature and one tenth the calibration uncertainty in the linear regions.

**6. Breakpoint table**—Lake Shore temperature instruments provide a seamless solution for measuring temperature sensors and converting the measurement into temperature units. This conversion requires the entry of the temperature response curve into the instrument. For calibrated sensors, this is accomplished through the use of a breakpoint table. With each calibration, Lake Shore provides breakpoint table formats to optimize the performance of the sensor when used with a Lake Shore instrument. The formats provided are compatible with any Lake Shore instrument produced over the last twenty years that accepts user curves. Software is also provided to install the breakpoint table file into most instruments using USB, Ethernet, IEEE-488, or RS-232 interfaces (instrument dependent).

In addition to the breakpoint table and software mentioned above, the CalCurve™ service provides the user with additional alternatives for installing a temperature response curve into a Lake Shore instrument. When the sensor and instrument are ordered together, a factory installed CalCurve service can be provided. A CalCurve can be done in the field when additional or replacement sensors are installed. In this case, curve data is loaded into a non-volatile memory that can be installed into the instrument by the user.

If the sensor is used with customer provided equipment (e.g., voltmeter, current source, and computer) then the curve fit (Chebychev or cubic spline) described in number 4 above should be used. The breakpoint tables are not necessary in this case.

**Caution: Proper calculation of a breakpoint table is based upon the interpolation method utilized by the specific instrument for which it is intended. The use of the breakpoint table in an instrument that uses a different interpolation method can cause significant conversion errors.**



## Lake Shore calibration services

- Recalibration
- Calibration report on CD-ROM
- Expanded interpolation table
- CalCurve™
- Certificate of conformance
- Second copy of calibration report

### Recalibration

The stability of a temperature sensor over time is dependent on both its operating environment and history of use. These environmental effects contribute to the degradation of calibration over time:

- Ionizing radiation
- Thermal shock
- Thermal stress from continuous exposure to high temperatures (relative to the sensor materials)
- Mechanical shock
- Improper use
- Corrosion (a serious problem for systems of dissimilar metallurgies in the presence of moisture and chemical agents such as salts—this includes integrated circuits and other electronics)
- Electrical stress/electromagnetic interference (EMI)/electrostatic discharge (ESD)

There are no specific published regulations or guidelines that establish requirements for the frequency of recalibration of cryogenic temperature sensors. There are certainly military standards for the recalibration of measuring devices. However, these standards only require that a recalibration program be established and then adhered to in order to fulfill the requirements.

Temperature sensors are complex assemblies of wires, welds, electrical connections, dissimilar metallurgies, electronic packages, seals, etc., and hence have the potential for drift in calibration. Like a voltmeter, where components degrade or vary with time and use, all of the “components” of a temperature sensor may also vary, especially where they are joined together at material interfaces. Degradation in a sensor materials system is less apparent than deterioration in performance of a voltmeter.

Lake Shore sensor calibrations are certified for one year. Depending upon the sensor type and how it is used, it is recommended that sensors be recalibrated in the Lake Shore Calibration Service Department periodically. Certainly, recalibration before important experiments would be advisable.

Sensors stored at a consistent temperature have been shown to remain stable over a long period of time.

### 8000 CalCurve™

The 8000 CalCurve™ on CD-ROM is provided free of charge at the time of order to any customer who orders a calibrated sensor. The 8000 is the calibration breakpoint interpolation data. Also on the CD is a PC executable program to load the data into a Lake Shore instrument. Once the data is loaded into the instrument, the user can calculate and display temperature with the data. The following information is included with the 8000 CalCurve™:

- Raw data
- Coefficients
- Interpolation table
- Instrument breakpoints
- A program for installing curves into instrument
- Instructions describing all file formats and contents

There is a charge to load previously stored calibration curves.



## Appendix E: Temperature Measurement System

The goal is to measure the temperature of some system. The ability to do so accurately and with the required resolution depends on a variety of factors. The calibration report from Lake Shore (or any calibration facility) is only the first step in determining the accuracy of the temperature measurement in the end-user's system.

A more quantifiable term than accuracy is total uncertainty of the measurement. This is simply the measurement itself and an estimate of all the errors of the measurement. Smaller errors are considered more accurate. The first step in estimating the errors in a customer system is the calibration itself. Essentially, a calibration is a series of resistance or voltage measurements of an unknown sensor and a corresponding measurement of an established temperature. By accounting for all the uncertainties of the measurement (installation, instrumentation, etc.) a total uncertainty is estimated. The actual accuracy a customer can expect will depend on this and other factors:

### 1. Design errors: *Can the system be measured by the sensor?*

These are errors of design and happen prior to sensor installation. For example, whether or not the sensor can be mounted on or near the sample to be measured could be a design error. If it is too far away, there can be thermal lags and offsets due to thermal conductance of the sample. Another example would be using too large a sensor to measure small samples. The thermal mass of the sensor could bias the temperature of the sample.

Design errors also apply to the physical construction of the sensor. This affects the reproducibility of the sensor over thermal cycling. Some sensors are more fragile than others and more prone to physical damage (for example carbon-glass RTDs).

### 2. Installation and environment errors: *Does the interaction of the sensor and system disturb the measurement?*

This would include installation errors and environmental effects. If leads are not properly heat sunk, they will introduce a heat load into the sensor. This affects the sensor's measurement and can also affect the sample. It can bias the reading of temperature as well as directly affect the temperature if the heat leak is great enough. Other interactions include thermal radiation, magnetic fields, and radiation.

### 3. Operation and instrumentation errors: *Does the instrumentation introduce errors to the measurement?*

Instrumentation is a crucial component to the total quality of the measurement. The choice of 2-lead or 4-lead measurements, excitation currents, instrument resolution, and accuracy all affect the measurement. Additionally, grounding errors, RF noise coupling, and thermal EMFs can introduce noise to the measurement.

Error terms can be classified into two classes:

**Type A**, (or random): Errors that can be evaluated by statistical methods.

**Type B**, (or systematic): Errors that can be evaluated by other means.

Most random errors are the result of instrumentation: uncertainty in the current source and voltage measurements. Other random errors are the actual assignment of a temperature (transferring ITS-90 or PLTS-2000), and interpolation errors. Design, installation, and environmental errors are systematic. For example, sensors in magnetic fields will create an offset to the measurement. This offset can be estimated from prior information or directly measured by other means (isothermal measurements with and without field). RF noise can also cause both random errors (adds to current noise) and systematic errors since at ultra-low temperatures the added noise can self-heat the sensors causing a systematic offset.

### Installation

2-lead vs. 4-lead installations can lead to significant measurement errors. Even with a properly installed temperature sensor, poor thermal design of the overall apparatus can produce measurement errors. Installation issues are addressed in Appendix C: Sensor Packaging and Installation, along with detailed installation instructions for specific Lake Shore sensors.

### Environmental concerns

Temperature sensors can be affected by changes in the environment. Examples include magnetic fields, ionizing radiation, or changes in the pressure, humidity, or chemistry of the environment. The most common are magnetic field and radiation-induced errors. These effects have been discussed previously. These environmental effects will create a systematic bias in the temperature measurement.



## Instrumentation

### 2-lead versus 4-lead

The measurement of resistance and diode temperature sensors requires passing a current through the temperature sensor to produce a sensor voltage that can be measured. The simplest resistance or voltage measurement configuration is a current source connected to the temperature sensor with a voltmeter connected to the current leads as shown in Figure 1. The current source can be represented as an ideal current source ( $I_s$ ) in parallel with a shunt resistance,  $R_s$ . The voltmeter, normally a digital multimeter (DMM) can be modeled as an ideal voltmeter ( $V_{in}$ ) in parallel with an input impedance,  $R_{in}$ .

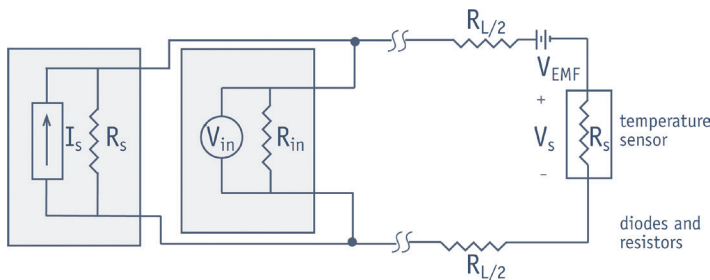

Figure 1—2-lead resistance measurement

The dominant source of error in a 2-lead resistance measurement is usually the resistance of the lead wires connecting the current source to the temperature sensor. In a cryogenic environment, the flow of heat down the leads of the cryostat is of critical concern due to the potential for sensor element heating. Normally, wire of small diameter and significant resistance per unit length is preferred to minimize this heat flow. Consequently, the resulting lead resistance can become a significant percentage of the resistance measured. The wire also has its own temperature sensitivity of resistance.

The equivalent error the lead resistance represents depends on the sensor type and sensor sensitivity. The 100  $\Omega$  platinum RTD has a nominal resistance of 100  $\Omega$  at 273.15 K (0  $^{\circ}$ C). The IEC 751 standard for the temperature sensitivity for platinum RTDs is 0.385  $\Omega$ /K between 273.15 K and 373.15 K (0  $^{\circ}$ C to 100  $^{\circ}$ C). Both the magnitude of the resistance and the temperature sensitivity are relatively small numbers, especially when the lead resistance may be several ohms. A 10  $\Omega$  lead resistance would result in a positive 26 K error in this temperature range (10  $\Omega$ /0.385  $\Omega$ /K = 26 K). The effect of lead resistance becomes even greater as the temperature decreases, since the temperature sensitivity ( $dR/dT$ ) of platinum sensors decreases with decreasing temperature.

Additionally, it is not uncommon for the internal lead resistance of the current leads (parasitic resistance) of a germanium or carbon-glass sensor to be as much as 10% to 20% or more of the sensor 4-lead resistance. Consequently, the 4-lead calibrated resistance-temperature data is of little use for a 2-lead measurement and the temperature error associated with 2-lead resistance measurements for germanium

and carbon-glass is almost always extremely large. The parasitic resistance for Cernox<sup>®</sup> temperature sensors, due to having common current and voltage contact, is extremely small. Even still, the low temperature error due to lead resistance can be at least 3 mK for 100  $\Omega$  of lead resistance. Since lead wire has its own temperature dependence, the error could be much larger. Table 1 shows typical error with 2-lead measurement.

In order to eliminate the effects of lead resistance, a 4-lead measurement (Figure 2) is normally used. Two of the leads, I+ and I-, supply current to the sensor, while the other two leads, V+ and V-, are used to eliminate the effect of lead resistance by measuring the voltage at the sensor voltage leads (4-lead sensor) or directly at the device leads (2-lead sensor). The reason this measurement scheme works is that the IR drop in the current leads is not measured, and the voltage drop in the voltage leads is extremely small due to the very small current required by the voltmeter (picoamperes or less) to make the voltage measurement.

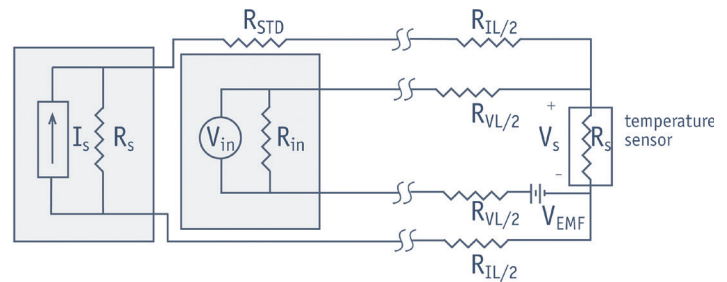

Figure 2—4-lead resistance measurement

A diode temperature sensor measurement requires a fixed 10  $\mu$ A current source and a voltmeter. As with resistance measurements, the dominant source of error in a 2-lead diode measurement is often the lead resistance. A 100  $\Omega$  lead resistance will result in a 1 mV voltage error at a current of 10  $\mu$ A. The Lake Shore DT-400 Series silicon diode temperature sensors have an average sensitivity of approximately  $-26$  mV/K below 30 K, resulting in a temperature error of 40 mK (1 mV/26 mV/K = 0.038 K); above 30 K the sensitivity is approximately  $-2.3$  mV/K, resulting in error exceeding 400 mK (1 mV/2.3 mV/K = 0.435 K). Consequently, unless the lead resistance can be reduced in magnitude or the resultant error can be tolerated, a 4-lead measurement is recommended.

Table 1—Typical errors for Cernox<sup>®</sup> 1070 resistor with lead resistance at 100  $\Omega$  (50  $\Omega$  each lead)

	R ( $\Omega$ )	dR/dT ( $\Omega$ /K)	$\Delta T$ (mK)
4.2 K	52444	-33321	-3.0
20 K	2851.6	-200.70	-498
100 K	317.44	-4.3908	large
300 K	68.949	-0.3052	very large



### Voltmeter input impedance

The voltmeter input impedance is generally not a problem in 2- or 4-lead measurements. It is not uncommon for today's voltmeters to have a 109  $\Omega$  or 1010  $\Omega$  input impedance in the voltage ranges of interest, which is large when compared to the temperature sensor resistance. Consequently, virtually no current will be shunted from the temperature sensor into the voltage measurement circuitry at these input impedance levels. A voltmeter input impedance of 109  $\Omega$  would produce only a 0.0001% error in a 1000  $\Omega$  resistance measurement.

### Current source output impedance

The output impedance of a good current source is also not ordinarily a problem in either 2- or 4-lead measurements, for the same reason. If the output impedance is not large compared to the sensor resistance, then a known series resistor should be placed in one of the current paths, and the current to the sensor should be measured by measuring the voltage across the known standard resistance.

### Thermoelectric and zero offset voltages

Voltages develop in electrical conductors with temperature gradients when no current is allowed to flow (Seebeck effect). Thermoelectric voltages appear when dissimilar metals are joined and joints are held at different temperatures. Typical thermoelectric voltages in cryogenic measurement systems are on the order of microvolts.

This effect can be minimized by a few steps. The same material should be used for conductors whenever practical, and the number of connections, or joints, in the measurement circuit should be minimized. Low thermal EMF solder can also be used (cadmium-tin solder has a lower thermal EMF than tin-lead solder by a factor of ten).

In addition to thermal offset, the instrumentation can have a zero offset (the signal value measured with no input to the measuring instrument). The zero offset can drift with time or temperature and is usually included in the instrument specifications.

The total offset voltage can be measured by reversing the current. When reading the voltage with the current in the forward direction, the voltmeter will read:

$$V^+ = V_s + V_{EMF} \quad \text{Eqn. 1}$$

where  $V_s$  is the actual voltage reading of the sensor, and  $V_{EMF}$  is the lead thermal EMFs. When the current is reversed, the voltmeter will read

$$V^- = -V_s + V_{EMF} \quad \text{Eqn. 2}$$

When the current is reversed, the voltage due to the sensor reverses sign while the thermal EMFs do not. The true voltage ( $V$ ) across the sensor is

$$V = (V^+ - V^-)/2 = V_s \quad \text{Eqn. 3}$$

By averaging the forward and reverse current voltage measurements, the error in the voltage measurement due to thermal EMFs is eliminated.

Diode measurements do not allow current reversal. The value of the offset voltage can be estimated by shorting the leads at the diode and measuring the offset voltage with zero excitation current at operating temperature.

Thermal EMFs in the sensor leads and connections do not have as big an effect on diode measurements as they do on resistance measurements, since the diode signal levels are much larger (typically a few tenths of a volt at room temperature to several volts at 4.2 K).

### Grounding

Signal grounding is important to the stability and repeatability of measurements. A measurement system that includes sensors, instruments, cabling, and possibly computer interfacing requires careful grounding.

Improper grounding of instruments or grounding at multiple points can allow current flows which result in small voltage offsets. The current flow through ground loops is not necessarily constant, resulting in a fluctuating voltage. Current can flow in the ground loop as it acts as a large aperture for inductive pickup. Also, current can result if there is a potential difference due to multiple grounds.

As each instrument handles grounding differently, it is important to carefully read your instrument manual for grounding suggestions. The grounding and isolation is handled differently in the Model 370 than in other Lake Shore instruments, since it is used for ultra-low temperature measurements. Ideally, there should be one defined ground for the measurement, and the cryostat is the best choice. Realistically, however, there are many instruments, wiring, and pumps attached to the cryostat. Each instrument may have its own ground. Simply attaching ground straps may create more ground loops.

Books on grounding and shielding can help to identify and eliminate both ground loops and electromagnetic noise.

### Reducing AC signal interference (RF noise)

Signal leads and cables are very susceptible to interference from unwanted AC signals in the RF frequency range. They act like antennas and pick up noise from computers, monitors, instrumentation, radio broadcasts, and other sources. Signals are either inductively coupled or capacitively coupled. The induced signals circulate as noise current in the measurement leads and distort measurements. There are other concerns when diodes are used as the sensing element, as discussed in the next section.



There are several ways to reduce the effect of AC signals. First, when possible, remove or shield the source of unwanted signals. Second, make each pair of signal leads as bad an antenna as possible. This can be accomplished by keeping them short and using twisted leads. Twisting reduces loop area to make leads that are prone to picking up noise smaller targets to electromagnetic signals. Twisting also helps to cancel unwanted signals in leads that are prone to transmit noise. In a typical 4-lead measurement, the current leads should be twisted together and the voltage leads should be twisted together. Third, put a conductive shield around all the leads to divert electric field signals and prevent capacitive coupling into the leads. Tie the shield to the ground closest in potential to the measurement. Many Lake Shore instruments provide a shield pin on the sensor connector for this purpose. The shield should be tied only at the instrument. Attaching at any other point can cause ground loops that were previously discussed.

In cases where shielding is not enough, filtering the unwanted signals can be considered. It is very difficult to add a filter to a measurement system without changing the measurement. One type of filter that has proven to work is a ferrite bead (see the Accessories section). The bead will act like a high impedance to unwanted high frequency signals and not affect the slow moving desired signals being measured. The Lake Shore 2071 ferrite bead can be clamped around existing wiring.

The greatest concern relates to leads external to the cryostat. Ideally, the cryostat itself acts as the shield for all wiring internal to it. However, it is still possible for cross-talk between different signal leads. In this application Lake Shore recommends Quad-Twist™ cryogenic wire, which has two twisted pairs of phosphor bronze wire that minimize noise pickup and allow proper heat sinking. In extreme cases coaxial cable may be needed, although it is much more difficult to heat sink.

### Measurement errors in diode thermometers due to AC interference

Wiring techniques are especially important when using diode thermometers in a measurement system. Noise currents produce a shift in measurement. Because diodes have a nonlinear voltage response to the changing current, the shift is seen as a lower measured voltage corresponding to a higher measured temperature. The temperature error in noisy systems can be as high as several tenths of a kelvin.

The following equation can be used to estimate the temperature shift with DT-470 silicon diodes over the range  $0 < V_{\text{RMS}} < 40$  mV and  $30 < T < 300$  K. The temperature errors tend to decrease at temperatures below 30 K ( $\Delta T$  in K,  $T$  in K, and  $V_{\text{RMS}}$  in mV).

$$\Delta T = 2.7768 \cdot T^{-1.11953} \cdot V_{\text{RMS}}^{2.01803} \quad \text{Eqn. 4}$$

There are two simple techniques that can be used to determine if this problem is present in the measuring system. The first is to connect a 10  $\mu\text{F}$  capacitor in parallel with the diode to act as a shunt for any induced AC currents. The capacitor must have low leakage current so

it does not alter the DC current through the diode. If the DC voltage reading across the diode increases with the addition of the capacitor, AC noise currents are present. The second method involves the measurement of the AC voltage across the diode. While an oscilloscope is the logical choice for looking at AC signals, many do not have the sensitivity required and often introduce unwanted grounds into the system and compound the problem. An AC voltmeter should be used.

Lake Shore instrumentation includes a 1  $\mu\text{F}$  capacitor across the current source in order to minimize the effects of noise related to power line frequency. A 0.1  $\mu\text{F}$  capacitor in parallel with a 30 pF to 50 pF capacitor at the voltage measurement input are used to minimize the effects of AC-coupled digital noise. The obvious disadvantage of the addition of AC filtering is that it slows down the response time of the measurement system.

### Effect of current source accuracy

**Diode temperature sensors**—Measurement accuracy of diode sensors is not as strongly dependent upon the current source accuracy as is the case with resistance temperature sensors. Diode sensors possess a nonlinear forward current-voltage characteristic. Consequently, the forward voltage variation with changing current for diodes is smaller than for resistance temperature sensors, which have linear current-voltage characteristics.

Below 30 K, the sensitivity ( $dV/dT$ ) of Lake Shore diode temperature sensors increases by an order of magnitude over sensitivities at higher temperatures. The slope ( $dV/dI$ ) of the I-V curves (Table 2) stays relatively constant. Both characteristics further reduce the effect of any change in forward bias current on temperature measurement accuracy.

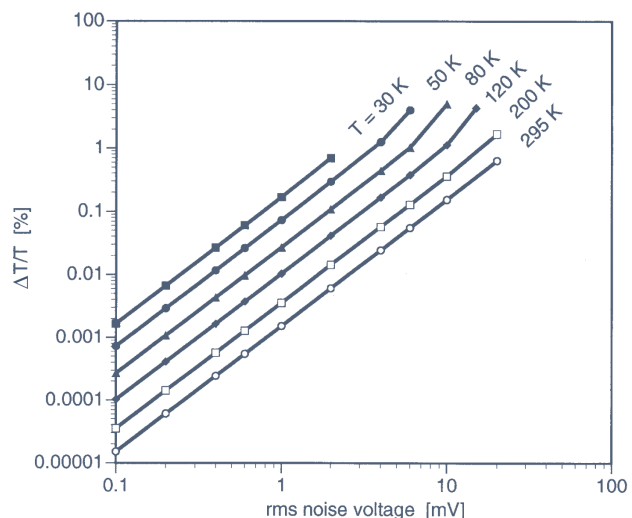

Figure 3—Calculated temperature reading shifts due to voltage noise across a Lake Shore Model DT-470 silicon diode temperature sensor



### Effect of current source accuracy

**Diode temperature sensors**—Measurement accuracy of diode sensors is not as strongly dependent upon the current source accuracy as is the case with resistance temperature sensors. Diode sensors possess a nonlinear forward current-voltage characteristic. Consequently, the forward voltage variation with changing current for diodes is smaller than for resistance temperature sensors, which have linear current-voltage characteristics.

Below 30 K, the sensitivity (dV/dT) of Lake Shore diode temperature sensors increases by an order of magnitude over sensitivities at higher temperatures. The slope (dV/dI) of the I-V curves (Table 2) stays relatively constant. Both characteristics further reduce the effect of any change in forward bias current on temperature measurement accuracy.

**Table 2 – Approximate dV/dI values for the DT-470 sensor**

Approximate dV/dI (Ω)	
300 K	3000
100 K	1000
40 K	700
4.2 K	2800

**Table 3—Equivalent temperature offsets for the DT-470 diode temperature sensors at selected current source uncertainties**

	dV/dI (Ω)	dV/dT (mV/K)	Temperature offset (mK)	
			dI(%)=0.05	dI(%)=0.1
300 K	3000	-2.40	6.5	13
100 K	1000	-2.04	2.5	5
40 K	700	-1.74	2.0	4
4.2 K	2800	-33.6	0.4	1

Lake Shore diode current sources are typically set to 10 μA ±0.1% or better and have a low-pass filter to minimize the effect of AC pickup in the current leads. Resultant errors due to current source inaccuracy are on the order of 10 mK or less for diode sensors.

If the output from a current source is not precisely 10 μA, the resultant error in temperature can be calculated using this relationship between the dV/dT and dV/dI values:

$$\Delta T = ((dV/dI)/(dV/dT))\Delta I \quad \text{Eqn. 5}$$

Note: dV/dI and dV/dT values are derived at the same temperature T.

In the above expression,  $R_d = dV/dI$  and  $R_s = V/I$  are the dynamic and static resistances of the temperature sensor. Note that the dynamic and static resistances of an ohmic sensor are equal. Results shown in Table 3.

**Resistance temperature sensors**—for resistance sensors, an error in current measurement is inversely related to the resultant measurement error of resistance:

$$\begin{aligned} R - \Delta R &= V/(I + \Delta I) && \text{Eqn. 6} \\ &\approx (V/I)(1 - \Delta I/I) \\ &= R - R(\Delta I/I) \end{aligned}$$

where I is the current setting, ΔI is the variation from that setting, and ΔR = RΔI/I.

The temperature error, ΔT, due to current source uncertainty, ΔI(%), is

$$\begin{aligned} \Delta T &= \Delta R/(dR/dT) && \text{Eqn. 7} \\ &= R(\Delta I/I)/(dR/dT) \\ \Delta T &= \Delta I(\%) / [(100/R)(dR/dT)] \end{aligned}$$

where ΔI(%) = 100 ΔI/I

All Lake Shore resistance current sources are typically set to 0.01%. For example (Table 4), temperature errors for a platinum resistance sensor near room temperature due to the current source can approach 36 mK and diminish to less than 10 mK below 100 K.

**Table 4—Equivalent temperature offsets for selected resistance sensors at selected voltmeter and current source uncertainties**

	T (K)	R (Ω)	dR/dT (Ω/K)	Temperature offset (mK)	
				dV(%)=0.01 dI(%)=0.01	dV(%)=0.05 dI(%)=0.05
PT-100	300	110.452	0.388	28.5	142.5
	100	29.987	0.411	7.3	36.5
	40	5.938	0.291	2.0	10
CGR-1-1000	300	6.21021	-0.0047	132	660
	100	9.66389	-0.0465	20.8	104
	40	16.8227	-0.3211	5.2	26
	4.2	964.19	-842.21	0.1	1
CX-1050	300	50.1	-0.165	30.4	152
	100	154.62	-1.55	10.0	50
	40	376.1	-8.9	4.2	21
	4.2	4596	-1867	0.2	1
GR-200A-1000	100	4.95987	-0.0469	10.6	53
	40	18.7191	-0.844	2.2	11
	4.2	981.026	-451.3	0.2	1





### Effect of voltage measurement accuracy

**Diode temperature sensors**—The effect of voltage measurement accuracy on resultant temperature measurement is not difficult to calculate, provided that diode sensitivity is known for the temperature of interest. The potential temperature error,  $\Delta T_v$  is

$$\Delta T_v = \Delta V / [dV/dT] \quad \text{Eqn. 8}$$

Table 5 illustrates potential temperature error due to the voltage measurement.

**Table 5—Equivalent temperature offsets for the DT-470 diode temperature sensor at selected voltmeter uncertainties**

	T (K)	V (V)	dV/dT (mV/K)	Temperature offset (mK)	
				$\Delta V(\%)=0.01$	$\Delta V(\%)=0.05$
DT-470	300	0.51892	-2.40	21.6	108
	100	0.97550	-2.04	47.8	239
	40	1.08781	-1.74	62.5	313
	4.2	1.62602	-33.6	4.8	24

**Resistance temperature sensors**—for positive temperature coefficient resistors such as platinum or rhodium-iron, the potential temperature error,  $\Delta T_R$ , is

$$\begin{aligned} \Delta T_R &= \Delta R / [dR/dT] \quad \text{Eqn. 9} \\ &= [\Delta V/I] / [dR/dT] \end{aligned}$$

since from Ohm's law,  $\Delta V = I\Delta R$ .

But  $\Delta V (\%) = 100\Delta V/V$ ; therefore

$$\begin{aligned} \Delta T_R &= [V\Delta V (\%) / 100I] / [dR/dT] \quad \text{Eqn. 10} \\ &= [\Delta V (\%) \cdot R / 100] / [dR/dT] \\ \Delta T_R &= \Delta V (\%) / [(100/R) (dR/dT)], \text{ and} \\ \Delta T_R &= \Delta I(\%) / [(100/R)(dR/dT)] \end{aligned}$$

The temperature offsets in Table 4 are calculated using both of the above equations.

This is not surprising, as we are dealing with Ohm's Law and a linear system.

### Self-heating

Any difference between the temperature of the sensor and the environment the sensor is intended to measure produces a temperature measurement error or uncertainty. Dissipation of power in the temperature sensor will cause its temperature to rise above that of the surrounding environment. Power dissipation in the sensor is also necessary to make a temperature measurement. Minimization of the temperature measurement uncertainty thus requires balancing the uncertainties due to self-heating and output signal measurement.

Self-heating is really a combination of sensor design and instrumentation. The primary reason for self-heating offsets at low temperatures is the thermal boundary resistance between the active sensor element and its surroundings. The thermal boundary resistance has a very strong inverse cube relationship with temperature. This forces the instrumentation to be capable of sourcing a small excitation and measuring a small (voltage) signal. The optimum excitation power will be a function of sensor, resistance, and temperature.

Lake Shore temperature controllers each have different excitation currents for NTC RTDs which effectively defines the minimum temperature range of the instrument-sensor combination.

An estimate of the self-heating error including thermal resistance for select sensors and optimum excitation power is found in Table 6 (page 197).



### Thermal (Johnson) noise

Thermal energy produces random motions of the charged particles within a body, giving rise to electrical noise. The minimum root mean square (RMS) noise power available is given by  $P_n = 4kT \Delta f_n$ , where  $k$  is the Boltzmann constant and  $\Delta f_n$  is the noise bandwidth. Peak-to-peak noise is approximately five times greater than the RMS noise. Metallic resistors approach this fundamental minimum, but other materials produce somewhat greater thermal noise. The noise power is related to current or voltage noise by the relations:  $I = [P_n/R_d]^{0.5}$  and  $V = [P_n R_d]^{0.5}$ . The noise bandwidth is not necessarily the same as the signal bandwidth, but is approximately equal to the smallest of the following:

- $\pi/2$  times the upper 3 dB frequency limit of the analog DC measuring circuitry, given as approximately  $1/(4 R_{\text{eff}} C_{\text{in}})$  where  $R_{\text{eff}}$  is the effective resistance across the measuring instrument (including the instrument's input impedance in parallel with the sensor resistance and wiring) and  $C_{\text{in}}$  is the total capacitance shunting the input
- $0.55/t_r$  where  $t_r$  is the instrument's 10% to 90% rise time
- 1 Hz if an analog panel meter is used for readout
- One half the conversion rate (readings per second) of an integrating digital voltmeter

### Calibration uncertainty

Commercially calibrated sensors should have calibrations traceable to international standards. About the best accuracy attainable is represented by the ability of national standards laboratories. Many laboratories provide calibrations for a fee. The calibration uncertainty typically increases by a factor of 3 to 10 between successive devices used to transfer a calibration.

### Calibration fit interpolation uncertainty

Once a calibration is performed, an interpolation function is required for temperatures that lie between calibration points. The interpolation method must be chosen with care, since some fitting functions can be much worse than others. Common interpolation methods include linear interpolation, cubic splines, and Chebychev polynomials. Formulas based on the physics of the sensor material may give the best fits when few fit parameters are used.

Use of an interpolation function adds to the measurement uncertainty. The additional uncertainty due to an interpolation function can be gauged by the ability of the interpolation function to reproduce the calibration points. Each calibration can be broken up into several ranges to decrease the fitting uncertainties. Typical uncertainties introduced by the interpolation function are on the order of one tenth the calibration uncertainty.

### Combining measurement uncertainties

Estimating the quality of a measurement involves the following steps: 1) identify the relevant sources of measurement uncertainty, 2) change the units of all uncertainties to temperature, and 3) combine all of the uncertainties using the root sum of squares method described later. Examples of source of measurement uncertainties affecting the accuracy, but not the precision of a measurement include offset voltages and calibration uncertainties.

The expected uncertainty of a measurement is expressed in statistical terms. As stated in the Guide to the Expression of Uncertainty in Measurement:

“The exact values of the contributions to the error of the measurement arising from the dispersion of the observations, the unavoidable imperfect nature of the corrections, and incomplete knowledge are unknown and unknowable, whereas the uncertainties associated with these random and systematic effects can be evaluated. ...the uncertainty of a result of a measurement is not necessarily an indication of the likelihood that the measurement result is near the value of the measurand; it is simply an estimate of the likelihood of nearness to the best value that is consistent with presently available knowledge.”

The uncertainty is given the symbol  $u$  and has the same units as the quantity measured. The combined uncertainty  $u_c$  arising from several independent uncertainty sources can be estimated by assuming a statistical distribution of uncertainties, in which case the uncertainties are summed in quadrature according to

$$u_c = \sqrt{u_1^2 + u_2^2 + \dots + u_i^2 + \dots + u_n^2} \quad \text{Eqn. 11}$$

Both random and systematic uncertainties are treated in the same way. Note that both sides of Equation 11 can be divided by the measurement quantity to express the measurement uncertainty in relative terms. Finding statistical data suitable for addition by quadrature can be a problem; instrument and sensor specifications sometimes give maximum or typical values for uncertainties. Two approaches may be taken when dealing with maximum uncertainty specifications. The conservative approach is to use the specification limit value in the combined uncertainty calculation. The less conservative approach is to assume a statistical distribution within the specification limits and assume the limit is roughly three standard deviations, in which case one third of the specification limit is used in uncertainty calculations. The manufacturer may be able to supply additional information to help improve uncertainty estimates. Practical recommendations and procedures for problems related to the estimation of measurement uncertainties are discussed in greater detail by Rabinovich.



Table 6 gives examples of uncertainty calculations for two types of temperature sensors, the DT-470-SD silicon diode sensor, and the CX-1050-AA Cernox<sup>®</sup> sensor.

When Lake Shore accounts for uncertainties in calibration measurements, all the above issues are taken into consideration, and their contributions are estimated.

### References:

ISO/TAG 4/WG 3. *Guide to the Expression of Uncertainty in Measurement, First Edition*. Geneva, Switzerland: International Organization for Standardization, 1992.  
S. Rabinovich, *Measurement Errors*, College Park, Maryland: American Institute of Physics, 1993.

**Table 6—Combined temperature measurement calculation examples**

	DT-470-SD-11		CX-1050-AA	
Temperature, T	80 K		4.2 K	
Mounting environment (N-greased to block)	vacuum		liquid helium	
Static Electrical Resistance, $R_s$	101,525 $\Omega$ (static $R_s = V/I$ )		4920 $\Omega$ (static $R_s = V/I$ )	
Dynamic Electrical Resistance, $R_d$	1000 $\Omega$ (dynamic $R_d = dV/dI$ )		4920 $\Omega$ (dynamic $R_d = dV/dI$ )	
Excitation current, I	10 $\mu\text{A}$		1 $\mu\text{A}$	
Output voltage, V	1.01525 V		4.92 mV	
Dimensionless temperature sensitivity, $S_0$	-0.1521		-1.71	
	Value used	Temperature uncertainty $u_T/T$ (PPM)	Value used	Temperature uncertainty $u_T/T$ (PPM)
Uncertainties due to:				
<b>Measurement instrumentation</b> (Keithley Instruments 2000 DVM)				
Meter range full scale (FS)	10.00000 V		100.0000 mV	
Voltage accuracy specification (ppm)	$\pm(30+5 \text{ FS}/V)$	521	$\pm(50+35 \text{ FS}/V)$	445
<b>Sensor self-heating</b>				
Thermal resistance	$R_t = 1000 \text{ K/W}$	127	$R_t = 3500 \text{ K/W}$	4.1
<b>Excitation uncertainty (Lake Shore Model 120-CS)</b>				
Current accuracy specification	$u/I = 0.05\%$	32	$u/I = 0.1\%$	585
<b>Thermal noise</b>		0.02		0.2
<b>Thermal voltages and zero drift</b>	10 $\mu\text{V}$	65	0 <sup>1</sup>	0
<b>Electromagnetic noise<sup>2</sup></b>	2 mV	1040	0 <sup>1</sup>	0
<b>Calibration uncertainty</b>	0.250 K <sup>3</sup>	3130	4 mK	952
<b>Interpolation uncertainty<sup>4</sup></b>	313		95.2	
<b>Combined uncertainties (ppm)</b>	3357		1206	

<sup>1</sup> Eliminated by current reversal

<sup>2</sup> Assuming an AC voltage of 2 mV<sub>rms</sub> is read across the voltmeter terminals—the voltage is converted to an approximate temperature shift

<sup>3</sup> Calibration accuracy

<sup>4</sup> Assumed to be one tenth the calibration uncertainty



### Estimating self-heating of temperature sensors

Any difference between the temperature of the sensor and the environment the sensor is intended to measure produces a temperature measurement error or uncertainty. Dissipation of power in the temperature sensor will cause its temperature to rise above that of the surrounding environment. Power dissipation in the sensor is also necessary to make a measurement with most temperature sensors (exceptions include thermocouples and optical pyrometers). Minimization of the temperature measurement uncertainty thus requires balancing the uncertainties due to self-heating and output signal measurement. The possibility that other experimental considerations might impose more stringent limitations on the power that can be dissipated in the temperature sensor should also be considered.

Following are two approaches to dealing with the problem of self-heating:

1. Choose an excitation that allows acceptable instrumentation measurement uncertainty and check to make sure self-heating is negligible at one or two points where it is likely to be most significant.

An easy way to check for self-heating is to increase the power dissipation and check for an indicated temperature rise. Unfortunately, this procedure will not work with non-linear devices such as semiconductor diodes. An indication of the self-heating error can be made by reading the diode temperature in both a liquid bath and in a vacuum at the same temperature, as measured by a second thermometer not dissipating enough power to self-heat significantly.

2. Measure the thermal resistance in the temperature range of interest and calculate the optimum operating point.

Examination leads to the conclusion that an increase in the sensor output voltage will result in a decreasing temperature uncertainty, so long as the voltage uncertainty remains constant. This is possible with an ohmic sensor by increasing the excitation current. Unfortunately, a larger excitation will dissipate more power in the temperature sensor, raising its temperature above the surroundings.

The self-heating depends on the excitation power according to the equation

$$\Delta T_{sh} = P_s R_t = I^2 R_e R_t = V^2 R_t / R_e \quad \text{Eqn. 12}$$

where  $\Delta T_{sh}$  is the temperature rise due to self-heating,  $P_s$  is the power dissipated in the sensor,  $I$  is the excitation current,  $R_e$  is the electrical resistance, and  $R_t$  is the thermal resistance between the sensor and its environment. The thermal resistance is extremely difficult to calculate for all but the simplest cases and is best determined experimentally using the following procedure:

1. Mount the sensor as it will be used on a temperature controlled block or directly in liquid
2. Record the output voltage as a function of excitation current (I-V curve) until significant self-heating is observed (when  $R_e = V/I$  is no longer constant)
3. Replot the data as sensor temperature reading versus power dissipated (T versus P),
4. Fit the data with a linear equation of the form  $T = T_0 + R_t P_s$  to find the thermal resistance,  $R_t$

Thermal resistance values determined from some commercial resistance temperature sensors in common mounting configurations are shown as a function of temperature in Figure 4. The thermal resistance varies with the environment in and around the sensor package (vacuum, gas, liquid), sensor mounting (solder, grease, clamp pressure, epoxy, etc.) and details of sensor construction. The thermal resistances shown in the figure should be used only as a guide with reference to the source papers and preferably measurement on the actual sensor in the temperature range and environment of use. See [www.lakeshore.com](http://www.lakeshore.com) for additional notes and papers.

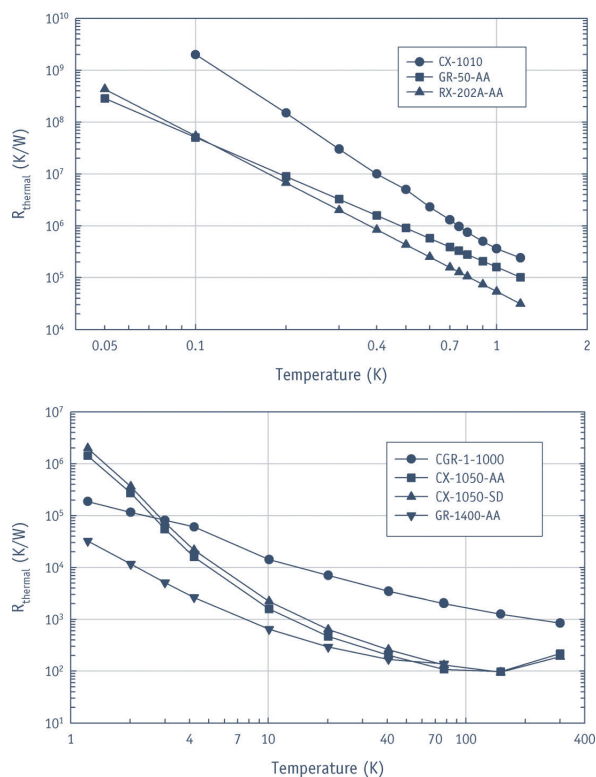

Figure 4—Thermal resistance data for various sensors as a function of  $T$



## Appendix F: PID Temperature Control

### Closed loop PID control

Closed loop PID control, often called feedback control, is the control mode most often associated with temperature controllers. In this mode, the controller attempts to keep the load at exactly the user entered setpoint, which can be entered in sensor units or temperature. To do this, it uses feedback from the control sensor to calculate and actively adjust the control (heater) output. The control algorithm used is called PID.

The PID control equation has three variable terms: proportional (P), integral (I), and derivative (D)—see Figure 1. The PID equation is:

$$\text{HeaterOutput} = P[e + I \int (e)dt + D \frac{de}{dt}] \quad \text{Eqn. 1}$$

where the error (e) is defined as:  $e = \text{Setpoint} - \text{Feedback Reading}$ .

### Proportional (P)

The proportional term, also called gain, must have a value greater than zero for the control loop to operate. The value of the proportional term is multiplied by the error (e) to generate the proportional contribution to the output:  $\text{Output (P)} = Pe$ . If proportional is acting alone, with no integral, there must always be an error or the output will go to zero. A great deal must be known about the load, sensor, and controller to compute a proportional setting (P). Most often, the proportional setting is determined by trial and error. The proportional setting is part of the overall control loop gain, as well as the heater range and cooling power. The proportional setting will need to change if either of these change.

### Integral (I)

In the control loop, the integral term, also called reset, looks at error over time to build the integral contribution to the output:

$$\text{Output(I)} = PI \int (e)dt. \quad \text{Eqn. 2}$$

By adding integral to the proportional contribution, the error that is necessary in a proportional-only system can be eliminated. When the error is at zero, controlling at the setpoint, the output is held constant by the integral contribution. The integral setting (I) is more predictable than the proportional setting. It is related to the dominant time constant of the load. Measuring this time constant allows a reasonable calculation of the integral setting.

### Derivative (D)

The derivative term, also called rate, acts on the change in error with time to make its contribution to the output:

$$\text{Output(D)} = PD \frac{de}{dt}. \quad \text{Eqn. 3}$$

By reacting to a fast changing error signal, the derivative can work to boost the output when the setpoint changes quickly, reducing the time it takes for temperature to reach the setpoint. It can also see the error decreasing rapidly when the temperature nears the setpoint and reduce the output for less overshoot. The derivative term can be useful in fast changing systems, but it is often turned off during steady state control because it reacts too strongly to small disturbances or noise. The derivative setting (D) is related to the dominant time constant of the load.

Figure 1—Examples of PID Control

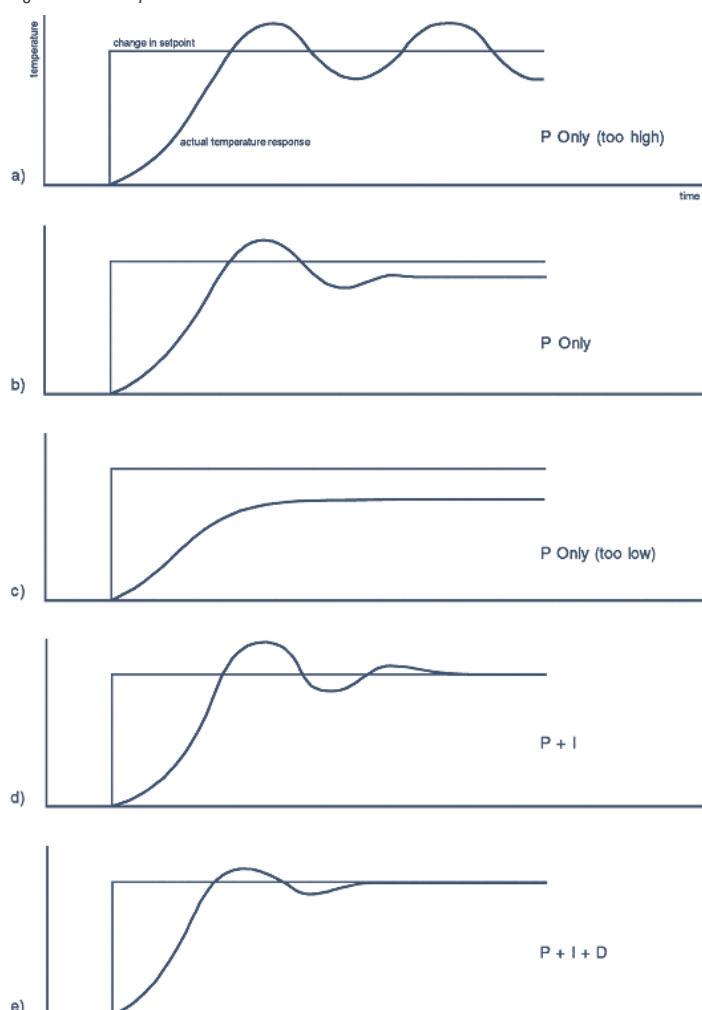



## Tuning a closed loop PID controller

There has been a lot written about tuning closed loop control systems and specifically PID control loops. This section does not attempt to compete with control theory experts. It describes a few basics to help users get started. This technique will not solve every problem, but it has worked for many others in the field. It is also a good idea to begin at the center of the temperature range of the cooling system.

### Setting heater range

Setting an appropriate heater output range is an important first part of the tuning process. **The heater range should allow enough heater power to comfortably overcome the cooling power of the cooling system.** If the heater range will not provide enough power, the load will not be able to reach the setpoint temperature. If the range is set too high, the load may have very large temperature changes that take a long time to settle out. Delicate loads can even be damaged by too much power.

Often there is little information on the cooling power of the cooling system at the desired setpoint. If this is the case, try the following: allow the load to cool completely with the heater off. Set manual heater output to 50% while in Open Loop control mode. Turn the heater to the lowest range and write down the temperature rise (if any). Select the next highest heater range and continue the process until the load warms up through its operating range. Do not leave the system unattended; the heater may have to be turned off manually to prevent overheating. If the load never reaches the top of its operating range, some adjustment may be needed in heater resistance or an external power supply may be necessary to boost the output power of the instrument.

The list of heater range versus load temperature is a good reference for selecting the proper heater range. It is common for systems to require two or more heater ranges for good control over their full temperature. Lower heater ranges are normally needed for lower temperature.

### Tuning proportional

The proportional setting is so closely tied to heater range that they can be thought of as fine and coarse adjustments of the same setting. An appropriate heater range must be known before moving on to the proportional setting.

Begin this part of the tuning process by letting the cooling system cool and stabilize with the heater off. Place the instrument in closed loop PID control mode, then turn integral, derivative, and manual output settings off. Enter a setpoint above the cooling system's lowest temperature. Enter a low proportional setting of approximately 5 or 10 and then enter the appropriate heater range as described above. The heater display should show a value greater than zero and less than 100% when temperature stabilizes. The load temperature should stabilize at a temperature **below** the setpoint. If the load temperature and heater display swing rapidly, the heater range or proportional value may be set too high and should be reduced. Very slow changes in load temperature that could be described as drifting are an indication of a proportional setting that is too low (which is addressed in the next step).

Gradually increase the proportional setting by doubling it each time. At each new setting, allow time for the temperature of the load to stabilize. As the proportional setting is increased, there should be a setting in which the load temperature begins a sustained and predictable oscillation rising and falling in a consistent period of time. (Figure 1a). The goal is to find the proportional value in which the oscillation begins. Do not turn the setting so high that temperature and heater output changes become violent. In systems at very low temperature it is difficult to differentiate oscillation and noise. Operating the control sensor at higher than normal excitation power can help.

Record the proportional setting and the amount of time it takes for the load change from one temperature peak to the next. This time is called the oscillation period of the load. It helps describe the dominant time constant of the load, which is used in setting integral. If all has gone well, the appropriate proportional setting is **one half** of the value required for sustained oscillation. (Figure 1b).

If the load does not oscillate in a controlled manner, the heater range could be set too low. A constant heater reading of 100% on the display would be an indication of a low range setting. The heater range could also be too high, indicated by rapid changes in the load temperature or heater output less than 10% when temperature is stable. There are a few systems that will stabilize and not oscillate with a very high proportional setting and a proper heater range setting. For these systems, setting a proportional setting of one half of the highest setting is the best choice.

### Tuning integral

When the proportional setting is chosen and the integral is set to zero (off), the instrument controls the load temperature below the setpoint. Setting the integral allows the control algorithm to gradually eliminate the difference in temperature by integrating the error over time. (Figure 1d). A time constant that is too high causes the load to take too long to reach the setpoint. A time constant that is too low can create instability and cause the load temperature to oscillate.

**Note: The integral setting for each instrument is calculated from the time constant. The exact implementation of integral setting may vary for different instruments. For this example it is assumed that the integral setting is proportional to time constant. This is true for the Model 370, while the integral setting for the Model 340 and the Model 331 are the inverse of the time constant.**



Begin this part of the tuning process with the system controlling in proportional only mode. Use the oscillation period of the load that was measured above in seconds as the integral setting. Enter the integral setting and watch the load temperature approach the setpoint. If the temperature does not stabilize and begins to oscillate around the setpoint, the integral setting is too low and should be doubled. If the temperature is stable but never reaches the setpoint, the integral setting is too high and should be decreased by half.

To verify the integral setting make a few small (2 to 5 degree) changes in setpoint and watch the load temperature react. Trial and error can help improve the integral setting by optimizing for experimental needs. Faster integrals, for example, get to the setpoint more quickly at the expense of greater overshoot. In most systems, setpoint changes that raise the temperature act differently than changes that lower the temperature.

If it was not possible to measure the oscillation period of the load during proportional setting, start with an integral setting of 50. If the load becomes unstable, double the setting. If the load is stable make a series of small setpoint changes and watch the load react. Continue to decrease the integral setting until the desired response is achieved.

### Tuning derivative

If an experiment requires frequent changes in setpoint or data taking between changes in the setpoint, derivative should be considered. (Figure 1e). A derivative setting of zero (off) is recommended when the control system is seldom changed and data is taken when the load is at steady state.

A good starting point is one fourth the integral setting in seconds (i.e.,  $\frac{1}{4}$  the integral time constant). Again, do not be afraid to make some small setpoint changes: halving or doubling this setting to watch the effect. Expect positive setpoint changes to react differently from negative setpoint changes.

### Manual output

Manual output can be used for open loop control, meaning feedback is ignored and the heater output stays at the user's manual setting. This is a good way to put constant heating power into a load when needed. The manual output term can also be added to the PID output. Some users prefer to set an output value near that necessary to control at a setpoint and let the closed loop make up the small difference.

**NOTE: Manual output should be set to 0 when not in use.**

### Typical sensor performance sample calculation: Model 331S temperature controller operating on the 2.5 V input range used with a DT-670 silicon diode at 1.4 K

- Nominal voltage—typical value taken from Appendix G: Sensor Temperature Response Data Tables.
- Typical sensor sensitivity—typical value taken from Appendix G: Sensor Temperature Response Data Tables.

- Measurement resolution in temperature equivalents

Equation: Instrument measurement resolution/typical sensor sensitivity

$$10 \mu\text{V} / 12.49\text{mV/K} = 0.8 \text{ mK}$$

The instrument measurement resolution specification is located in the Input Specifications table for each instrument.

- Electronic accuracy in temperature equivalents

Equation: Electronic accuracy (nominal voltage)/typical sensor sensitivity

$$(80 \mu\text{V} + (0.005\% \cdot 1.644 \text{ V})) / 12.49 \text{ mV/K} = \pm 13 \text{ mK}$$

The electronic accuracy specification is located in the Input Specifications table for each instrument.

- Temperature accuracy including electronic accuracy, CalCurve™, and calibrated sensor

Equation: Electronic accuracy + typical sensor accuracy at temperature point of interest

$$13 \text{ mK} + 12 \text{ mK} = \pm 25 \text{ mK}$$

The typical sensor accuracy specification is located in the Accuracy table for each instrument.

- Electronic control stability in temperature equivalents (applies to controllers only)

Equation: Up to 2 times the measurement resolution

$$0.8 \text{ mK} \cdot 2 = \pm 1.6 \text{ mK}$$



## Appendix G: Sensor Temperature Response Data Tables

Silicon diode DT-670		
T (K)	V (volts)	dV/dT (mV/K)
1.4	1.64429	-12.49
4.2	1.57848	-31.59
10	1.38373	-26.84
20	1.19775	-15.63
30	1.10624	-1.96
50	1.07310	-1.61
77.35	1.02759	-1.73
100	0.98697	-1.85
150	0.88911	-2.05
200	0.78372	-2.16
250	0.67346	-2.24
300	0.55964	-2.30
350	0.44337	-2.34
400	0.32584	-2.36
450	0.20676	-2.39
500	0.09068	-2.12

Silicon diode DT-470		
T (K)	V (volts)	dV/dT (mV/K)
1.4	1.6981	-13.1
4.2	1.6260	-33.6
10	1.4201	-28.7
20	1.2144	-17.6
30	1.1070	-2.34
50	1.0705	-1.75
77.35	1.0203	-1.92
100	0.9755	-2.04
150	0.8687	-2.19
200	0.7555	-2.31
250	0.6384	-2.37
300	0.5189	-2.4
350	0.3978	-2.44
400	0.2746	-2.49
450	0.1499	-2.46
475	0.0906	-2.22

Cernox® CX-1010*			
T (K)	R (Ω)	dR/dT (Ω/K)	(T/R)-(dR/dT)
0.1	21389	-558110	-2.70
0.2	4401.6	-38756	-1.76
0.3	2322.4	-10788	-1.39
0.4	1604.7	-4765.9	-1.19
0.5	1248.2	-2665.2	-1.08
1	662.43	-514.88	-0.78
1.4	518.97	-251.77	-0.68
2	413.26	-124.05	-0.60
3	328.95	-58.036	-0.53
4.2	277.32	-32.209	-0.49
6	234.44	-17.816	-0.46
10	187.11	-8.063	-0.43
20	138.79	-3.057	-0.44
30	115.38	-1.819	-0.47
40	100.32	-1.252	-0.50
50	89.551	-0.929	-0.52
77.35	70.837	-0.510	-0.56
100	61.180	-0.358	-0.59
150	47.782	-0.202	-0.63
200	39.666	-0.130	-0.66
250	34.236	-0.090	-0.66
300	30.392	-0.065	-0.65

\*Cernox sensors do not follow a standard response curve — the listed values are typical, but can vary widely; consult Lake Shore to choose a specific range

Cernox® CX-1030*			
T (K)	R (Ω)	dR/dT (Ω/K)	(T/R)-(dR/dT)
0.3	31312	-357490	-3.43
0.4	13507	-89651	-2.65
0.5	7855.7	-34613	-2.20
1	2355.1	-3265.2	-1.39
1.4	1540.1	-1264.9	-1.15
2	1058.4	-509.26	-0.96
3	740.78	-199.11	-0.81
4.2	574.20	-97.344	-0.71
6	451.41	-48.174	-0.64
10	331.67	-19.042	-0.57
20	225.19	-6.258	-0.56
30	179.12	-3.453	-0.58
40	151.29	-2.249	-0.59
50	132.34	-1.601	-0.61
77.35	101.16	-0.820	-0.63
100	85.940	-0.552	-0.64
150	65.864	-0.295	-0.67
200	54.228	-0.184	-0.68
250	46.664	-0.124	-0.67
300	41.420	-0.088	-0.64
350	37.621	-0.065	-0.61
400	34.779	-0.050	-0.57
420	33.839	-0.045	-0.55

\*Cernox sensors do not follow a standard response curve — the listed values are typical, but can vary widely; consult Lake Shore to choose a specific range



**Cernox® CX-1050\***

T (K)	R (Ω)	dR/dT (Ω/K)	(T/R)-(dR/dT)
1.4	26566	-48449	-2.55
2	11844	-11916	-2.01
3	5733.4	-3042.4	-1.59
4.2	3507.2	-1120.8	-1.34
6	2252.9	-432.14	-1.15
10	1313.5	-128.58	-0.98
20	692.81	-30.871	-0.89
30	482.88	-14.373	-0.89
40	373.11	-8.392	-0.90
50	305.19	-5.507	-0.90
77.35	205.67	-2.412	-0.91
100	162.81	-1.488	-0.91
150	112.05	-0.693	-0.93
200	85.800	-0.397	-0.92
250	69.931	-0.253	-0.90
300	59.467	-0.173	-0.87
350	52.142	-0.124	-0.83
400	46.782	-0.093	-0.79
420	45.030	-0.089	-0.77

\*Cernox sensors do not follow a standard response curve — the listed values are typical, but can vary widely; consult Lake Shore to choose a specific range

**Cernox® CX-1080\***

T (K)	R (Ω)	dR/dT (Ω/K)	(T/R)-(dR/dT)
20	6157.5	-480.08	-1.56
30	3319.7	-165.61	-1.50
40	2167.6	-79.551	-1.47
50	1565.3	-45.401	-1.45
77.35	836.52	-15.398	-1.42
100	581.14	-8.213	-1.41
150	328.75	-3.057	-1.40
200	220.93	-1.506	-1.36
250	163.73	-0.863	-1.32
300	129.39	-0.545	-1.26
350	106.98	-0.368	-1.20
400	91.463	-0.261	-1.14
420	86.550	-0.231	-1.12

\*Cernox sensors do not follow a standard response curve — the listed values are typical, but can vary widely; consult Lake Shore to choose a specific range

**Cernox® CX-1070\***

T (K)	R (Ω)	dR/dT (Ω/K)	(T/R)-(dR/dT)
4.2	5979.4	-2225.3	-1.56
6	3577.5	-794.30	-1.33
10	1927.2	-214.11	-1.11
20	938.93	-46.553	-0.99
30	629.90	-20.613	-0.98
40	474.89	-11.663	-0.98
50	381.42	-7.490	-0.98
77.35	248.66	-3.150	-0.98
100	193.29	-1.899	-0.98
150	129.60	-0.854	-0.99
200	97.626	-0.477	-0.98
250	78.723	-0.299	-0.95
300	66.441	-0.201	-0.91
350	57.955	-0.143	-0.86
400	51.815	-0.106	-0.81
420	49.819	-0.094	-0.80

\*Cernox sensors do not follow a standard response curve — the listed values are typical, but can vary widely; consult Lake Shore to choose a specific range



## Germanium GR-50-AA

T (K)	R ( $\Omega$ )	dR/dT ( $\Omega/K$ )	(T/R)-(dR/dT)
0.05	35000	-3642000	-5.2
0.095	2725	-92170	-3.2
0.2	364.6	-4043	-2.2
0.3	164.0	-964.0	-1.8
0.5	73.75	-202.9	-1.4
1	33.55	-31.33	-0.93
1.4	24.73	-13.15	-0.74
2	19.32	-6.167	-0.64
3	15.59	-2.334	-0.45
4.2	13.66	-1.036	-0.32
5	13.02	-0.624	-0.24

## Germanium GR-1400-AA

T (K)	R ( $\Omega$ )	dR/dT ( $\Omega/K$ )	(T/R)-(dR/dT)
1.4	35890	-94790	-3.7
2	11040	-16670	-3.0
3	3636	-2977	-2.5
4.2	1689	-861.9	-2.1
6	800.7	-278.9	-2.1
10	252.8	-61.95	-2.5
20	44.19	-5.41	-2.4
30	17.18	-1.23	-2.1
50	6.45	-0.211	-1.6
77.35	3.55	-0.050	-1.1
100	2.80	-0.021	-0.74

## Germanium GR-300-AA

T (K)	R ( $\Omega$ )	dR/dT ( $\Omega/K$ )	(T/R)-(dR/dT)
0.3	35180	-512200	-4.4
0.5	5443	-34800	-3.2
1	875.7	-1901	-2.2
1.4	448.6	-581.3	-1.8
2	248.8	-187.4	-1.5
3	142.2	-60.14	-1.3
4.2	94.46	-26.56	-1.2
6	61.89	-12.42	-1.2
10	33.20	-3.97	-1.2
20	16.08	-0.750	-0.93
30	10.81	-0.383	-1.1
50	5.91	-0.148	-1.3
77.35	3.50	-0.050	-1.1
100	2.72	-0.024	-0.88

**Rox™ RX-102A**

T (K)	R (Ω)	dR/dT (Ω/K)	(T/R)-(dR/dT)
0.05	70020	-5090000	-3.6
0.1	19390	-266000	-1.4
0.2	8278	-43000	-1.0
0.3	5615	-16600	-0.89
0.5	3701	-5478	-0.74
1	2381	-1260	-0.53
1.4	2005	-667	-0.47
2	1726	-331	-0.38
3	1502	-152	-0.30
4.2	1370	-80.3	-0.25
6	1267	-40.5	-0.19
10	1167	-15.3	-0.13
20	1089	-3.96	-0.07
30	1063	-1.75	-0.05
40	1049	-1.06	-0.04

**Rox™ RX-103A**

T (K)	R (Ω)	dR/dT (Ω/K)	(T/R)-(dR/dT)
1.4	30750	-13570	-0.62
2	25090	-6550	-0.52
3	20710	-2940	-0.43
4.2	18150	-1560	-0.36
6	16130	-811	-0.3
10	14060	-315	-0.22
20	12290	-103	-0.17
30	11550	-52.4	-0.14
40	11150	-21.7	-0.08

**Rox™ RX-202A**

T (K)	R (Ω)	dR/dT (Ω/K)	(T/R)-(dR/dT)
0.05	110000	-12300000	-5.6
0.1	23340	-274000	-1.2
0.2	11420	-49000	-0.86
0.3	8364	-19400	-0.69
0.5	6069	-6791	-0.56
1	4366	-2000	-0.46
1.4	3797	-935	-0.34
2	3420	-440	-0.26
3	3112	-218	-0.21
4.2	2918	-121	-0.17
6	2757	-66.6	-0.15
10	2579	-31.6	-0.12
20	2390	-11.9	-0.10
30	2300	-6.88	-0.09
40	2244	-4.58	-0.08

**Rox™ RX-102B**

T (K)	R (Ω)	dR/dT (Ω/K)	(T/R)-(dR/dT)
0.01	9856.38	-413888	-0.42
0.02	7289.79	-170565	-0.47
0.03	5975.92	-100138	-0.50
0.04	5184.10	-62048	-0.48
0.05	4676.87	-41480	-0.44
0.1	3548.94	-12578	-0.35
0.2	2813.75	-4116	-0.29
0.3	2502.26	-2365	-0.28
0.5	2187.50	-1056	-0.24
1	1884.56	-350.8	-0.19
1.4	1779.33	-197.7	-0.16
2	1691.44	-114.5	-0.14
3	1606.45	-63.53	-0.12
4.2	1546.44	-40.04	-0.11
6	1488.89	-26.05	-0.11
10	1410.19	-15.43	-0.11
20	1300.92	-7.82	-0.12
30	1239.54	-4.83	-0.12
40	1198.80	-3.41	-0.11



## Platinum PT-100

T (K)	R ( $\Omega$ )	dR/dT ( $\Omega/K$ )	(T/R)·(dR/dT)
20	2.2913	0.085	0.74
30	3.6596	0.191	1.60
50	9.3865	0.360	1.90
77.35	20.380	0.423	1.60
100	29.989	0.423	1.40
150	50.788	0.409	1.20
200	71.011	0.400	1.10
250	90.845	0.393	1.10
300	110.354	0.387	1.10
400	148.640	0.383	1.00
500	185.668	0.378	1.00
600	221.535	0.372	1.00
700	256.243	0.366	1.00
800	289.789	0.360	1.00

Thermocouple type E ( $T_{Ref} = 273.15$  K)

T (K)	EMF ( $\mu$ V)	dV/dT ( $\mu$ V/K)
3.2	-9834.9	1.59
4.2	-9833.0	2.09
10	-9813.3	4.66
20	-9747.0	8.51
30	-9643.8	12.1
40	-9505.5	15.5
50	-9334.2	18.7
75	-8777.7	25.6
100	-8063.4	31.4
150	-6238.1	41.2
200	-3967.4	49.3
250	-1328.7	56.0
300	1608.0	61.1
350	4777.7	65.6
400	8159.8	69.6
500	15426	75.3
600	23138	78.6
670	28694	80.0
700	31100	80.4
800	39179	81.0
900	47256	80.4
1000	55247	79.3
1100	63119	78.1
1200	70842	76.3
1270	76136	75.2

Thermocouple type K ( $T_{Ref} = 273.15$  K)

T (K)	EMF ( $\mu$ V)	dV/dT ( $\mu$ V/K)
3.2	-6457.7	0.743
4.2	-6456.9	0.916
10	-6448.5	2.01
10.5	-6447.4	2.12
20	-6417.8	4.15
30	-6365.1	6.39
40	-6290.0	8.61
50	-6193.3	10.7
75	-5862.9	15.6
100	-5417.6	19.9
150	-4225.5	27.5
200	-2692.8	33.5
250	-897.60	38.0
300	1075.3	40.6
350	3135.8	41.5
400	5200.0	40.8
500	9215.6	40.3
600	13325	41.7
670	16264	42.2
700	17533	42.4
800	21789	42.6
900	26045	42.4
1000	30251	41.7
1100	34373	40.7
1200	38396	39.7
1270	41153	39.0
1300	42318	38.7
1400	46131	37.5
1500	49813	36.1
1600	53343	34.5
1640	54712	34.0



# Appendix H: Common Units and Conversions

## Temperature

Fahrenheit to Celsius:  $^{\circ}\text{C} = (^{\circ}\text{F} - 32) / 1.8$

Celsius to Fahrenheit:  $^{\circ}\text{F} = (1.8 \times ^{\circ}\text{C}) + 32$

Fahrenheit to Kelvin: convert  $^{\circ}\text{F}$  to  $^{\circ}\text{C}$ , then add 273.15

Celsius to Kelvin: add 273.15

## Volume

1 liter (l) =  $1.000 \times 10^{-3}$  cubic meters ( $\text{m}^3$ ) = 61.02 cubic inches ( $\text{in}^3$ )

## Mass

1 kilogram (kg) = 1000 grams (g) = 2.205 pounds (lb)

## Force

1 newton (N) = 0.2248 pounds (lb)

## Electric resistivity

1 micro-ohm-centimeter ( $\mu\Omega\text{-cm}$ )

=  $1.000 \times 10^{-6}$  ohm-centimeter ( $\Omega\text{-cm}$ )

=  $1.000 \times 10^{-8}$  ohm-meter ( $\Omega\text{-m}$ )

= 6.015 ohm-circular mil per foot ( $\Omega\text{-circ mil/ft}$ )

## Heat flow rate

1 watt (W) = 3.413 Btu/h

1 British thermal unit per hour (Btu/h) = 0.2930 W

### A Note on SI

The values in this catalog are expressed in International System of Units, or SI (from the French *Le Système International d'Unités*). Whenever possible, the common CGS or British equivalent has been parenthetically included as well.

These common conversions and constants have been included as a reference.

Please refer to NIST Special Publication 811 "Guide for the Use of the International System of Units (SI)" for further standards and conversions.

### References:

Barry N. Taylor, NIST Special Publication 811, 1995 Edition, Guide for the Use of the International System of Units (SI), Washington, U.S. Government Printing Office, April 1995.

The NIST Physical Constants webpage (<http://www.nist.gov/pml/data/physicalconst.cfm>)

## Length

	centimeter (cm)	meter (m)	inch (in)
centimeter (cm)	1	$1.000 \times 10^{-2}$	0.3937
meter (m)	100	1	39.37
inch (in)	2.540	$2.540 \times 10^{-2}$	1

1 micrometer (sometimes referred to as micron) =  $10^{-6}$  m

1 mil =  $10^{-3}$  in

## Area

	$\text{cm}^2$	$\text{m}^2$	$\text{in}^2$	circ mil
$\text{cm}^2$	1	$10^{-4}$	0.1550	$1.974 \times 10^5$
$\text{m}^2$	$10^4$	1	1550	$1.974 \times 10^9$
$\text{in}^2$	6.452	$6.452 \times 10^{-4}$	1	$1.273 \times 10^6$
circ mil	$5.067 \times 10^{-6}$	$5.067 \times 10^{-10}$	$7.854 \times 10^{-7}$	1

## Pressure

	pascal (Pa)	millibar (mbar)	torr (Torr)	atmosphere (atm)	psi (lbf/in <sup>2</sup> )
pascal (Pa)	1	$1.000 \times 10^{-2}$	$7.501 \times 10^{-3}$	$9.868 \times 10^{-6}$	$1.450 \times 10^{-4}$
millibar (mbar)	$1.000 \times 10^2$	1	$7.502 \times 10^{-1}$	$9.868 \times 10^{-4}$	$1.450 \times 10^{-2}$
torr (Torr)	$1.333 \times 10^2$	$1.333 \times 10^0$	1	$1.316 \times 10^{-3}$	$1.934 \times 10^{-2}$
atmosphere (atm)	$1.013 \times 10^5$	$1.013 \times 10^3$	$7.600 \times 10^2$	1	$1.470 \times 10^1$
psi (lbf/in <sup>2</sup> )	$6.897 \times 10^3$	$6.895 \times 10^1$	$5.172 \times 10^1$	$6.850 \times 10^{-2}$	1

1 torr (Torr) =	133.332 pascal (Pa)	1.33 millibar (mbar)	0.001316 atmosphere (atm)	0.01934 psi (lbf/in <sup>2</sup> )
1 pascal (Pa) =	0.01 millibar (mbar)	0.007501 torr (Torr)	$9.87 \times 10^{-6}$ atmosphere (atm)	$1.45 \times 10^{-4}$ psi (lbf/in <sup>2</sup> )

## Magnetic induction B

	gauss (G)	kiloline/in <sup>2</sup>	Wb/m <sup>2</sup>	milligauss (mG)	gamma ( $\gamma$ )
gauss (G)	1	$6.452 \times 10^{-3}$	$10^{-4}$	1000	$10^5$
kiloline/in <sup>2</sup>	155.0	1	$1.550 \times 10^{-2}$	$1.550 \times 10^5$	$1.550 \times 10^7$
Wb/m <sup>2</sup>	$10^4$	64.52	1	$10^7$	$10^9$
milligauss (mG)	0.001	$6.452 \times 10^{-6}$	$10^{-7}$	1	100
gamma ( $\gamma$ )	$10^{-5}$	$6.452 \times 10^{-8}$	$10^{-9}$	0.01	1

1 ESU =  $2.998 \times 10^9$  Wb/m<sup>2</sup>

## Magnetomotive force

	abampere-turn	ampere-turn	Gilbert (Gi)
abampere-turn	1	10	12.57
ampere-turn	0.1	1	1.257
Gilbert (Gi)	$7.958 \times 10^{-2}$	0.7958	1

1 pragilbert =  $4\pi$  ampere-turn

1 ESU =  $2.655 \times 10^{-11}$  ampere-turn



### Magnetic field strength H

	abampere-turn/cm	ampere-turn/cm	ampere-turn/in	ampere-turn/m	oersted (Oe)
abampere-turn/cm	1	10	25.40	1000	12.57
ampere-turn/cm	0.1	1	2.540	100	1.257
ampere-turn/in	$3.937 \times 10^{-2}$	0.3937	1	39.37	0.4947
ampere-turn/m	0.001	0.01	$2.540 \times 10^{-2}$	1	$1.257 \times 10^{-2}$
oersted (Oe)	$7.958 \times 10^{-2}$	0.7958	2.021	79.58	1

1 Oe = 1 Gi

1 ESU =  $2.655 \times 10^{-9}$  ampere-turn/m

1 praoersted =  $4\pi$  ampere-turn/m

### Energy, work, heat

	Btu	erg	J	cal	kW-h
British thermal unit	1	$1.055 \times 10^{10}$	1055	252.0	$2.930 \times 10^{-4}$
erg	$9.481 \times 10^{-11}$	1	$10^{-7}$	$2.389 \times 10^{-8}$	$2.778 \times 10^{-14}$
joule (J)	$9.481 \times 10^{-4}$	$10^7$	1	0.2389	$2.778 \times 10^{-7}$
calorie (cal)	$3.968 \times 10^{-3}$	$4.186 \times 10^7$	4.186	1	$1.163 \times 10^{-6}$
kilowatt hour (kW-h)	3413	$3.6 \times 10^{13}$	$3.6 \times 10^6$	$8.601 \times 10^5$	1

1 electronvolt (eV) =  $1.602 \times 10^{-19}$  joules (J)

### Fundamental physical constants

Quantity	Symbol	Value*	Unit
speed of light in a vacuum	$c, c_0$	299792458	$m \cdot s^{-1}$
magnetic constant	$\mu_0$	$4\pi \times 10^{-7} = 12.566370614... \times 10^{-7}$	$N \cdot A^{-2}$
electric constant $1/\mu_0 c^2$	$\epsilon_0$	$8.854187817... \times 10^{-12}$	$F \cdot m^{-1}$
characteristic impedance of vacuum $\sqrt{\mu_0/\epsilon_0} = \mu_0 c$	$Z_0$	376.730313461...	$\Omega$
Planck constant	$h$	$6.6260693(11) \times 10^{-34}$	$J \cdot s$
in eV · s		$4.13566743(35) \times 10^{-15}$	eV · s
$h/2\pi$	$\hbar$	$1.05457168(18) \times 10^{-34}$	$J \cdot s$
in eV · s		$6.58211915(56) \times 10^{-16}$	eV · s
elementary charge	$e$	$1.60217653(14) \times 10^{-19}$	C
magnetic flux quantum $h/2e$	$\Phi_0$	$2.06783372(18) \times 10^{-15}$	Wb
Avogadro constant	$N_A, L$	$6.0221415(10) \times 10^{23}$	$mol^{-1}$
atomic mass constant $m_u = \frac{1}{12}m(^{12}C) = 1 u$	$m_u$	$1.66053886(28) \times 10^{-27}$	kg
Faraday constant $N_A e$	$F$	96485.3383(83)	$C \cdot mol^{-1}$
molar gas constant	$R$	8.314472(15)	$J \cdot mol^{-1} \cdot K^{-1}$
Boltzmann constant $R/N_A$	$k$	$1.3806505(24) \times 10^{-23}$	$J \cdot K^{-1}$
molar volume of ideal gas $RT/p$			
T = 273.15 K, p = 101.325 kPa	$V_m$	$22.413996(39) \times 10^{-3}$	$m^3 \cdot mol^{-1}$
T = 273.15 K, p = 100 kPa	$V_m$	$22.710981(40) \times 10^{-3}$	$m^3 \cdot mol^{-1}$
Stefan-Boltzmann constant $(\pi^2/60)k^4/h^3c^2$	$\sigma$	$5.670400(40) \times 10^{-8}$	$W \cdot m^{-2} \cdot K^{-4}$
electron volt: (e/C)J	eV	$1.60217653(14) \times 10^{-19}$	J
Bohr magneton $eh/2m_e$	$\mu_B$	$927.400949(80) \times 10^{-26}$	$J \cdot T^{-1}$
in eV · T <sup>-1</sup> [ $\mu_B/(J \cdot T^{-1})$ ](e/C)		$5.788381804(39) \times 10^{-5}$	eV · T <sup>-1</sup>

\*Values are shown in their concise form with uncertainty in parentheses. Numbers with uncertainty values are subject to revision. Refer to the NIST Reference on Constants, Units, and Uncertainty website for the latest values



# Appendix I: Cryogenic Reference Tables

## Cryogenic heat flow calculations

The heat flow  $\dot{Q}$  conducted across small temperature differences can be calculated using the formula:

$$\dot{Q} = -KA \frac{dT}{dx} \cong -KA \frac{\Delta T}{L} \quad \text{Eqn. 1}$$

where K is the thermal conductivity, A is the cross-sectional area,  $\Delta T$  is the temperature difference, and L is the length of the heat conduction path.

Thermal conduction across significant temperature differences should be calculated using thermal conductivity integrals.

Note that the thermal conductivity and the thermal conductivity integral of a material can depend strongly on composition and fabrication history. Without verification, the data in the accompanying figures should be used only for qualitative heat flow calculations.

Calculating the heat conduction through a body with its ends at greatly different temperatures is made difficult by the strong temperature dependence of the thermal conductivity between absolute zero and room temperature. The use of thermal conductivity integrals (called thermal boundary potentials by Garwin) allows the heat flow to be calculated as

$$\dot{Q} = -G(\theta_2 - \theta_1) \quad \text{Eqn. 2}$$

where  $\theta$  is the integral of the temperature-dependent thermal conductivity, K, calculated as

$$\theta_1 = \int_0^{T_1} KdT \quad \text{Eqn. 3}$$

and G is a geometry factor calculated as

$$\frac{1}{G} = \int_{x_1}^{x_2} \frac{dx}{A} \quad \text{Eqn. 4}$$

where A(x) is the cross sectional area at position x along the path of heat flow.

Note that  $G=A/L$  in the case of a body of length L and uniform cross-sectional area A.

Equation 1 is only applicable to bodies within which a common thermal conductivity integral function applies.

Reference: R. L. Garwin, *Rev. Sci. Instrum.* 27 (1956) 826.



**Figure 1—Thermal conductivity of selected materials**

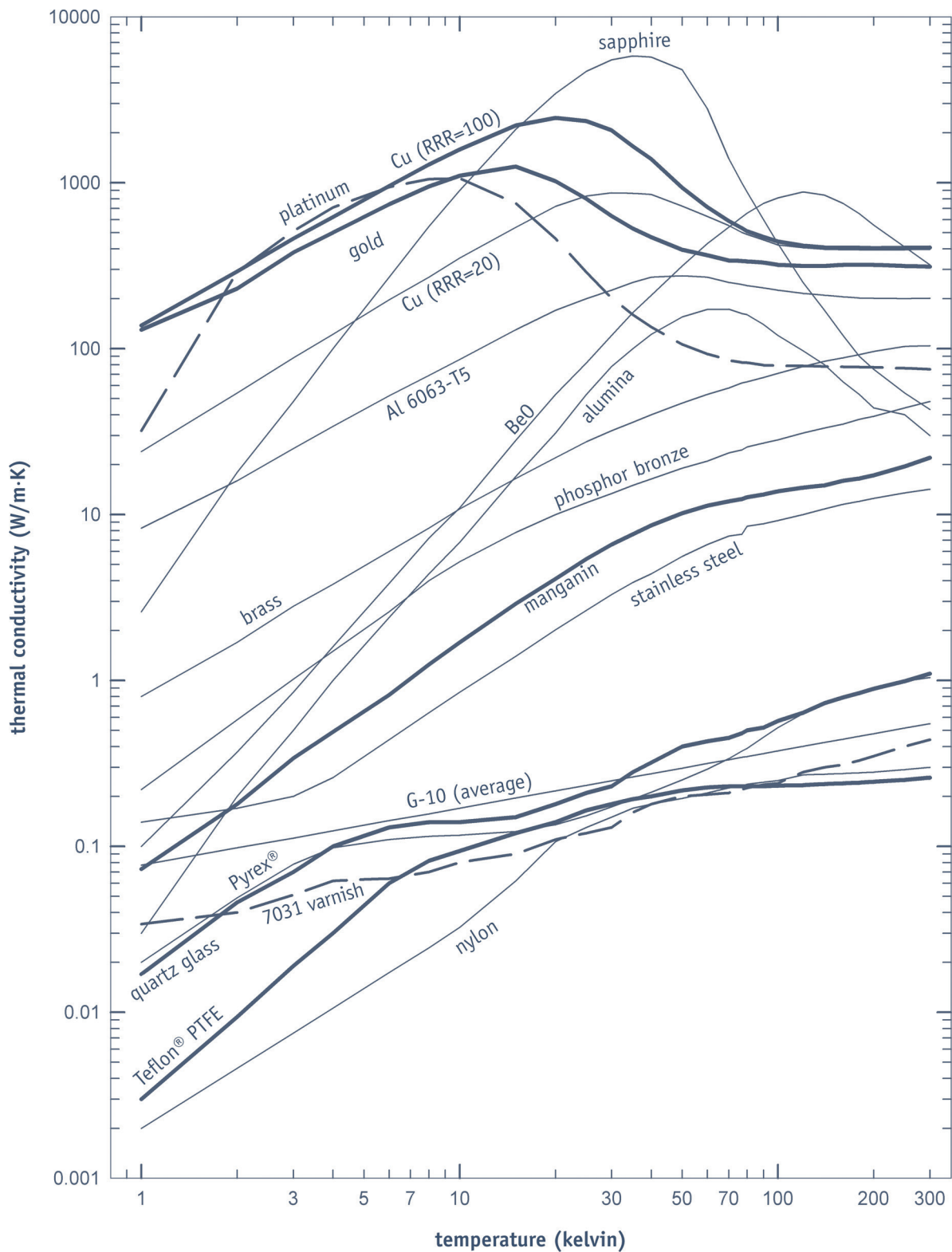
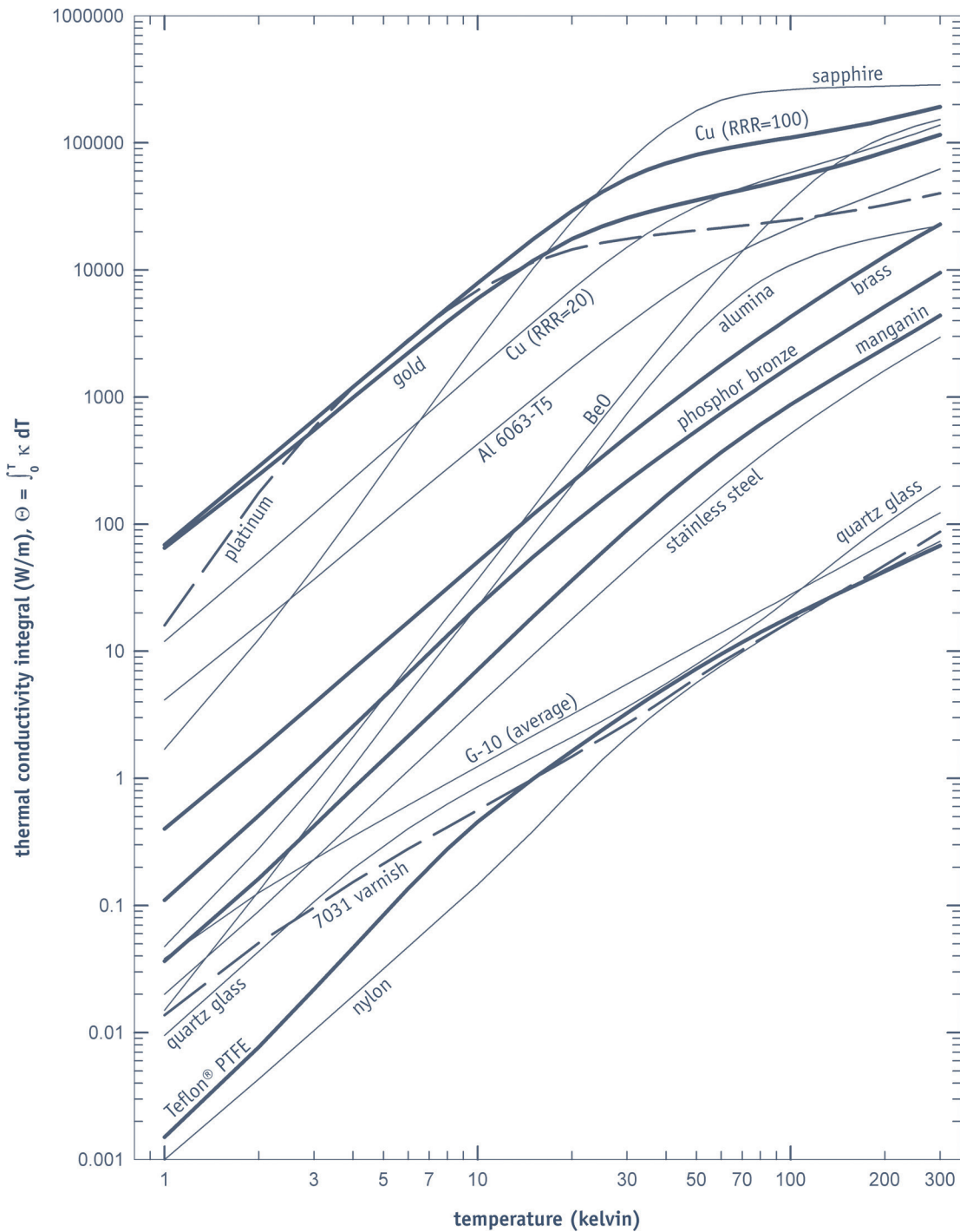





Figure 2—Thermal conductivity integral of selected materials



**Table 1—Thermodynamic properties for various cryogenic liquids**

	Temperature (K) pressure			Latent heat of vaporization				
	Triple point	Normal boiling point	Critical point	Triple point (kPa)	Critical point (kPa)	Critical density (kg/m <sup>3</sup> )	L (J/g)	Density (g/ml)
Helium	2.1768 <sup>a</sup>	4.222	5.1953	5.048	227.46	69.64	20.6	0.13
Hydrogen	13.8	20.28	32.94	7.042	1283.8	31.36	441	0.07
Neon	24.5561	27.09	44.44	43.35	2703	483.23	86	1.20
Nitrogen	63.15	77.36	126.26	12.46	3399	313.11	199	0.81
Oxygen	54.36	90.19	154.58	0.148	5043	436.14	213	1.14
Argon	83.8	87.28	150.86	68.9	4906	535.70	162	1.40
Krypton	115.76	119.77	209.39	73.2	5496	910.75	108	2.40
Xenon	161.36	165.04	289.74	81.6	5821	1100	96	3.10
CO <sub>2</sub>	216.58	—	304.21	518.16	7384	466.51	571	1.56
Methane	90.69	111.63	190.55	11.7	4599	162.65	510	0.42
Ethane	90.35	184.55	305.33	0.0011	4871	206.73	489	0.55
Propane	85.47	231.07	369.85	0.1 × 10 <sup>-6</sup>	4248	220.49	425	0.58
Ammonia	195.49	239.81	406.65	0.0662	11627	237.57	1371	0.68

<sup>a</sup> Triple point values for helium are those of the lambda point

**Table 2—Gamma radiation-induced calibration offsets as a function of temperature for several types of cryogenic temperature sensors**

	Model	Radiation-induced offset (mK) at temperature				
		4.2 K	20 K	77 K	200 K	300 K
Platinum <sup>b</sup>	PT-103	NA	-15	-10 <sup>d</sup>	10 <sup>d</sup>	10 <sup>d</sup>
Cernox <sup>b</sup>	CX-1050-SD	-10	-10 <sup>d</sup>	-5 <sup>d</sup>	25 <sup>d</sup>	25 <sup>d</sup>
Germanium <sup>b</sup>	GR-1400-AA	-5	-20	-25	NA	NA
Ruthenium oxide <sup>b</sup>	RO600	20	150	<sup>d</sup>	<sup>d</sup>	NA
Silicon diode <sup>b</sup>	DT-470-SD	25	1000	1300	1000	2700
Silicon diode <sup>b</sup>	DT-500P-GR-M	350	50	20	250	300
Silicon diode <sup>b</sup>	SI-410-NN	600	2000	300	450	1400
Platinum <sup>c</sup>	PT-103	NA	-50	5 <sup>d</sup>	50	75
Germanium <sup>c</sup>	GR-1400-AA	2 <sup>d</sup>	2 <sup>d</sup>	5 <sup>d</sup>	NA	NA
Silicon diode <sup>c</sup>	DT-470-SD	+20	-200	1500	11000	18000
Silicon diode <sup>c</sup>	DT-500P-GR-M	10 <sup>d</sup>	10 <sup>d</sup>	-5 <sup>d</sup>	-5 <sup>d</sup>	-100

<sup>b</sup> Sensors were irradiated *in situ* at 4.2 K with a cobalt-60 gamma source at a dose rate of 3,000 Gy/hr to a total dose of 10,000 Gy ( $1 \times 10^6$  rad)

<sup>c</sup> Sensors were irradiated at room temperature with a cesium-137 gamma source at a dose of 30 Gy/hr to a total dose of 10,000 Gy ( $1 \times 10^6$  rad)

<sup>d</sup> Deviations smaller than calibration uncertainty

**Table 3—Vapor pressure of some gases at selected temperatures in Pascal (Torr)**

	4 K	20 K	77 K	150 K	Triple <sup>e</sup> point temperature
Water	<i>f</i>	<i>f</i>	<i>f</i>	$1.33 \times 10^{-4}$ ( $10^{-7}$ )	273 K
Carbon dioxide	<i>f</i>	<i>f</i>	$1.33 \times 10^{-5}$ ( $10^{-8}$ )	1333 (10)	217 K
Argon	<i>f</i>	$1.33 \times 10^{-10}$ ( $10^{-13}$ )	21332 (160)	<i>h</i>	84 K
Oxygen	<i>f</i>	$1.33 \times 10^{-10}$ ( $10^{-13}$ )	19998 (150)	<i>h</i>	54 K
Nitrogen	<i>f</i>	$1.33 \times 10^{-8}$ ( $10^{-11}$ )	97325 (730)	<i>g</i>	63 K
Neon	<i>f</i>	4000 (30)	<i>g</i>	<i>g</i>	25 K
Hydrogen	$1.33 \times 10^{-4}$ ( $10^{-7}$ )	101,325 (760)	<i>g</i>	<i>g</i>	14 K

Note: estimates—useful for comparison purposes only (1 Torr = 133.3 Pa)

<sup>e</sup> Solid and vapor only at equilibrium below this temperature; no liquid

<sup>f</sup> Less than  $10^{-13}$  Torr

<sup>g</sup> Greater than 1 atm

<sup>h</sup> Above the critical temperature, liquid does not exist

**Table 4—Thermal contraction of selected materials between 293 K and 4 K**

	Contraction (per 10 <sup>4</sup> )
Teflon <sup>®</sup>	214
Nylon	139
Stycast <sup>®</sup> 1266	115
SP22 Vespel <sup>®</sup>	63.3
Stycast <sup>®</sup> 2850FT	50.8
Stycast <sup>®</sup> 2850GT	45
Al	41.4
Brass (65% Cu/35% Zn)	38.4
Cu	32.6
Stainless steel	30
Quartz a-axis	25
Quartz c-axis	10
Quartz mean, for typical transducer	15
Titanium	15.1
Ge	9.3
Pyrex <sup>®</sup>	5.6
Si	2.2

**Table 5—Electrical resistivity of alloys (in  $\mu\Omega\text{-cm}$ )**

	Resistivity (295 K)	(4.2 K)
Brass	7.2	4.3
Constantan	52.5	44
CuNi (80% Cu/20% Ni)	26	23
Evanohm <sup>®</sup>	134	133
Manganin	48	43
Stainless steel	71 to 74	49 to 51



Table 6—Defining fixed points of the ITS-90

Temperature ( $T_{90}/K$ )	Substance <sup>i</sup>	State <sup>i</sup>	Defining instrument	
0.65 to 3	3He	Vapor pressure point	He vapor pressure thermometer	Constant volume gas thermometer
3 to 5	He	Vapor pressure point		
13.8033	e-He <sub>2</sub>	Triple point		
~17	e-He <sub>2</sub> (or He)	Vapor pressure point or gas thermometer point		
~20.3	e-He <sub>2</sub> (or He)	Vapor pressure point or gas thermometer point		
24.5561	Ne	Triple point		
54.3584	O <sub>2</sub>	Triple point	Platinum resistance thermometer	
83.8058	Ar	Triple point		
234.3156	Hg	Triple point		
273.16	H <sub>2</sub> O	Triple point		
302.9146	Ga	Melting point		
429.7485	In	Freezing point		
505.078	Sn	Freezing point		
692.677	Zn	Freezing point		
933.473	Al	Freezing point		
1234.93	Ag	Freezing point		
1337.33	Au	Freezing point	Radiation	
1357.77	Cu	Freezing point		

<sup>i</sup> All substances except 3He are of natural isotopic composition; e-H<sub>2</sub> is hydrogen at the equilibrium concentration of the ortho- and para-molecular forms

<sup>i</sup> For complete definitions and advice on the realization of these various states, see “Supplementary Information for the ITS-90”

Table 7—Saturated vapor pressure of helium

T (K)	P (Pa)	T (K)	P (Pa)	T (K)	P (Pa)
5.1	211600	3.4	41590	1.7	1128
5	196000	3.3	36590	1.6	746.4
4.9	181000	3.2	32010	1.5	471.5
4.8	167000	3.1	27840	1.4	282.0
4.7	154300	3	24050	1.3	157.9
4.6	141900	2.9	20630	1.27	130.7
4.5	130300	2.8	17550	1.24	107.3
4.4	119300	2.7	14810	1.21	87.42
4.3	108900	2.6	12370	1.18	70.58
4.2	99230	2.5	10230	1.15	56.45
4.1	90140	2.4	8354	1.12	44.68
4	81620	2.3	6730	1.09	34.98
3.9	73660	2.2	5335	1.06	27.07
3.8	66250	2.1	4141	1.03	20.67
3.7	59350	2	3129	1	15.57
3.6	52960	1.9	2299		
3.5	47040	1.8	1638		







# Customer Service

**218** Ordering Information

**220** Lake Shore Limited Warranty





# Ordering Information

## Shop online 24 hours a day

[shop.lakeshore.com](http://shop.lakeshore.com) is your one stop source for the most updated product information, pricing, and applications. Visit it to browse, compare, and purchase products. For your convenience, all the products found in this catalog can be purchased online using a credit card.

## To place an order

Lake Shore products are always being improved. We suggest contacting your local representative or our website for the most current product and pricing information. Please see [www.lakeshore.com](http://www.lakeshore.com) to find your local sales representative or dealer.

For maximum efficiency, please be ready to provide us with the following items:

- Purchase order number
- Bill-to address and contact
- Ship-to address
- Name and phone number of purchasing agent
- Name and phone number of technical contact
- Tax status (if applicable)
- Name and model number of products ordered, including any options or accessories
- Line voltage (if applicable)

## Pricing and quotations

The price lists that may be included with this catalog are U.S. list prices at the time of approval for printing. Lake Shore reserves the right to change prices without notice. The price for an order is determined by the price prevailing at the time the order is received. Therefore, any prices included with this catalog are intended only for budgetary information. To obtain destination prices, formal quotations, pro forma invoices, or other information before ordering, contact Lake Shore or your local representative.

## Product changes

Product information and illustrations in this catalog were current as of press time. Lake Shore, in a continuing effort to offer excellent products, reserves the right to change specifications, designs, and models without notice. Please visit [www.lakeshore.com](http://www.lakeshore.com) for the most updated information on products and services.

## Terms and conditions of sale

### Scope

The following Terms and Conditions (Terms) apply to all sales made by Lake Shore Cryotronics, Inc. (Lake Shore), except where there is a conflict between the Terms and a contractual agreement contained in a purchaser's written Sales Agreement, in which case the Sales Agreement shall control.

### Payment

**Visa, MasterCard, and American Express**—Lake Shore accepts Visa, MasterCard, and American Express from customers in Canada and the United States and from foreign companies when an American or Canadian financial institution issues the credit card. Credit card orders limited to \$50,000 USD or at the discretion of Lake Shore.

**Inside the U.S.**—Unless otherwise stated in writing, full payment must be received within 30 days of invoice date.

**Outside the U.S.**—Payment terms acceptable to Lake Shore Cryotronics, Inc., unless otherwise agreed upon in writing, are as follows:

- A) Payment with the order.
- B) Payment prior to shipment. Note: acceptable payment methods are bank draft (check) or telegraphic transfer (T/T). A sight draft is not acceptable.
- C) Irrevocable letter of credit. Note: There is an additional documentation processing fee if payment is made with a letter of credit. The purchaser shall be responsible for the additional fee at the time of Payment.

Product lines requiring operational training and verification (OT&V) will be billed in two installments:

1. When product is shipped; and,
2. When OT&V is performed.

Full payment for product lines requiring OT&V and for any product for which Lake Shore sends the purchaser an invoice under the above stated Payment terms must be received within 30 days of each invoice date, unless otherwise agreed upon in writing.

### Taxes

Unless otherwise stated, all prices that are quoted to the Purchaser are exclusive of use, sales, and similar taxes. The Purchaser shall be responsible to pay Lake Shore the amount of all taxes for which Lake Shore is responsible to remit the tax on a product or service at the time of the Purchaser's Payment, as outlined above. Such taxes that do apply directly to the Purchaser's order shall be paid to Lake Shore by the purchaser, unless an exemption certificate is supplied to Lake Shore that is acceptable to pertinent taxing authorities.

Where Lake Shore is not responsible to remit the tax on sale to pertinent governmental entities, then the Purchaser shall be responsible to remit such tax. Value Added Tax (VAT) and other export taxes are the responsibility of the purchaser.

### Minimum charge

There is a \$75 minimum charge for orders placed with a purchase order (PO) and a \$5,000 minimum charge for orders placed with a letter of credit (LC). There is no minimum order charge for other payment methods accepted by Lake Shore.

### Delivery

Proposed delivery dates are based upon Lake Shore production schedules at the time of Lake Shore's receipt of the Purchaser's order. However, Lake Shore shall not be liable for any direct or indirect Purchaser damages for default in or delay in delivery. Transportation charges between the Lake Shore factory or warehouse and the Purchaser's delivery point are payable by the Purchaser as a separate invoice item unless otherwise set forth in the quotation and contract in writing.





## Shipment

**Hazardous materials:** Lake Shore reserves the right to separate the hazardous materials from the rest of the purchaser's shipment and to send hazardous materials directly to the customer via the "Best Way" available, in accord with Lake Shore's discretion, without incurring any liability to Purchaser for default in or delay in delivery of the same to the Purchaser or for its decision to treat the goods as hazardous materials, regardless as to how the purchaser originally scheduled the transport of the goods purchased.

1. Lake Shore cannot guarantee delivery of International hazardous materials shipments without conducting an investigation of each destination on a case-by-case basis because such materials are subject to a variety of controls and laws imposed by the various jurisdictions through which the products must pass.
2. Purchasers who order hazardous materials and then refuse to accept the hazardous materials shipment will be charged for all shipping costs and a re-stocking fee.

**Risk of loss:** Unless otherwise indicated in writing, the title to Purchaser's goods and risk of loss for such goods pass to Purchaser when the products have been delivered to the Purchaser's transport agent at Lake Shore Cryotronics, Inc.'s plant dock or shipping department in Westerville, Ohio.

1. Shipment is not insured by Lake Shore. If customer wishes insurance, this can be added at customer's expense.
2. The delivery receipt for the Purchaser's shipment will be *prima facie* evidence that the shipment was delivered in compliance with the terms of the sale agreement if there is no written notification of rejection of the goods sent by Purchaser to Lake Shore (whether such condition is immediately apparent or concealed). The Purchaser has the responsibility of verifying the condition of the goods on receipt;
3. Purchaser must reject purchased goods (whether such condition is immediately apparent or concealed) by notifying Lake Shore in writing within five (5) days from the date of the Purchaser's receipt of goods. No goods may be returned for credit without prior written consent from Lake Shore.

## Force majeure

Lake Shore shall not be liable for any damage or penalty for delay in or for failure in performance under its sale agreement with Purchaser, including any failure to give notice of delay in delivery due to the weather, acts of God, act of civil or military authority within any government, war, riot, concerted labor action, shortages of materials, or any other causes beyond the reasonable control of Lake Shore.

## Calibration information

All calibrations of Lake Shore products are performed to internally developed and validated methods.

Calibrations of "non-adjustable product" (including but not necessarily limited to temperature and magnetic sensors/probes) are calibrated by characterization and are not provided with a statement of conformity (i.e., passed or failed). Calibration uncertainties may be provided at the specific characterization points.

Calibrations of adjustable instrumentation involve the application of developed specifications, and reports include a statement of conformity (i.e., passed or failed). Where measurement uncertainty has been established, the "decision rule," in compliance with ISO17025, is for the pass/fail result to be based on tolerances that meet or exceed a 4:1 TUR, which incorporates the uncertainty of the calibration system. Where a tolerance does not meet a 4:1 TUR, guardbanding is applied to tighten the tolerance and ensure equivalent performance.

## Operational training & verification (OT&V)

The Purchaser warrants that the site where the products are to be installed is in all respects suitable for the safe and lawful installation and operation of the products. The Purchaser shall obtain any certificates or other approvals required prior to OT&V services and shall inform Lake Shore of all relevant safety, building, and electrical codes and other requirements relevant to the service. Purchaser shall indemnify Lake Shore against any liability or expense resulting from the Purchaser's failure to do so.

If Lake Shore has agreed to effect or supervise the Purchaser's OT&V of Lake Shore's products under the sale agreement, the Purchaser shall prepare the site prior to Lake Shore's arrival in accord with the sale and service agreement and the Purchaser shall provide all services (including labor) for efficient OT&V. If the Purchaser fails to perform its obligations under the OT&V sale and service agreement, Lake Shore shall be permitted to charge the Purchaser for Lake Shore's personnel costs due to the Purchaser's failure.

Upon completion of Purchaser's OT&V, Lake Shore may issue and Purchaser shall review and, if accurate, sign an "Acceptance of Product Certificate," (the Acceptance) within 10 days after the OT&V. The Acceptance shall verify OT&V services have been performed on the purchased equipment. The Acceptance shall be conclusive evidence of the Goods' and OT&V's conformity with the sale agreement contract.

If the Purchaser fails to return the Acceptance, or fails to respond to the issuance of the same to the Purchaser, then the Purchaser's failure to respond to the certificate within the time allotted shall constitute acceptance by the Purchaser.

## Cancellation

The Purchaser may cancel orders for catalog items if the Purchaser pays Lake Shore's re-stocking charge. (See Returned Goods below.)

A Purchaser's order for custom fabricated or non-catalog products can not be cancelled under any condition, and the Purchaser must remit the purchase price of such product to Lake Shore; the Purchaser and Lake Shore may reach mutually agreed terms in writing regarding other costs or expenses that are attributable to the Purchaser's election to terminate shipment of a product. However, the Purchaser shall be responsible for all expense or costs incurred or obligated by Lake Shore in relation to such product prior to the date and time of Purchaser's notification to Lake Shore of Purchaser's intent. Purchaser shall further indemnify Lake Shore from all such expense or cost

## Returned goods

**Goods may not be returned to Lake Shore for any reason, except with prior written authorization from Lake Shore. Unless otherwise agreed, authorized returned goods that are not properly rejected for compliance reasons are subject to a 15% re-stocking charge [there is a \$50.00 minimum charge for domestic US Purchasers and a \$60.00 minimum charge for International Purchasers on sensors and other temperature transducers], plus an assessment against the Purchaser of any additional expense required to return received material to first class salable condition.**

## Export regulations

Purchaser agrees to comply fully with all laws and regulations concerning the purchase and sale of products. In particular, Purchaser agrees to comply with the Export Administration Regulations of the United States in so far as they apply to the sale, re-sale and transport of products.

As part of Lake Shore's compliance with export regulations, Lake Shore collects and records end-user information to determine whether Lake Shore needs export licenses for its products. As such, all products must be delivered to the agreed upon contract ultimate destination, as shown on Lake Shore sale paperwork. Any in-transit diversion from the agreed upon ultimate destination is prohibited.



# Lake Shore Limited Warranty

**WARRANTY PERIOD:** THREE (3) YEARS for all products except system products. System products are TWO (2) YEARS. System products include but are not limited to; modular characterization systems, vibrating sample magnetometer systems, cryogenic probe stations, Hall effect systems, electromagnets, electromagnet power supplies, superconducting magnet systems, superconducting magnet power supplies, liquid nitrogen cooled cryostats, liquid helium cooled cryostats, cryogen free cryostats, and associated options and accessories.

**Manufacturer Limited Warranty.** The following is the limited warranty that Manufacturer offers on its Products. Distributor agrees that it shall not extend, expand or otherwise modify this limited warranty in any manner.

1. Lake Shore Cryotronics, Inc. ("**Lake Shore**") warrants that products manufactured by Lake Shore (the "**Product**") will be free from defects in materials and workmanship for the "**Warranty Period**" which starts on the date of shipment of the Product.
2. If Lake Shore receives notice of any such defects during the Warranty Period and the defective Product is shipped freight prepaid back to Lake Shore, Lake Shore will, at its option, either repair or replace the Product (if it is so defective) without charge for parts, service labor or associated customary return shipping cost to the Purchaser. Replacement for the Product may be by either new or equivalent in performance to new. Replacement or repaired parts, or a replaced Product, will be warranted for only the unexpired portion of the original warranty or 90 days (whichever is greater).
3. Lake Shore warrants the Product only if the Product has been sold by an authorized Lake Shore employee, sales representative, distributor or an authorized Lake Shore original equipment manufacturer (OEM).
4. The Product may contain remanufactured parts equivalent to new in performance or may have been subject to incidental use when it is originally sold to the Purchaser.
5. The Warranty Period begins on the date the Product ships from Lake Shore's plant.
6. This limited warranty does not apply to problems with the Product resulting from (a) improper or inadequate installation (unless OT&V services are performed by Lake Shore), maintenance, repair or calibration, (b) fuses, software, power surges, lightning and non-rechargeable batteries, (c) software, interfacing, parts or other supplies not furnished by Lake Shore, (d) unauthorized modification or misuse, (e) operation outside of the published specifications, (f) improper site preparation or site maintenance (g) natural disasters such as flood, fire, wind, or earthquake, or (h) damage during shipment other than original shipment to you if shipped through a Lake Shore carrier.
7. This limited warranty does not cover: (a) regularly scheduled or ordinary and expected recalibrations of the Product; (b) accessories to the Product (such as probe tips and cables, holders, wire, grease, varnish, feedthroughs, etc.); (c) consumables used in conjunction with the Product (such as probe tips and cables, probe holders, sample tails, rods and holders, ceramic putty for mounting samples, Hall sample cards, Hall sample enclosures, etc.); or, (d) non-Lake Shore branded Products that are integrated with the Product.
8. TO THE EXTENT ALLOWED BY APPLICABLE LAW, THIS LIMITED WARRANTY IS THE ONLY WARRANTY APPLICABLE TO THE PRODUCT AND REPLACES ALL OTHER WARRANTIES OR CONDITIONS, EXPRESS OR IMPLIED, INCLUDING, BUT NOT LIMITED TO, THE IMPLIED WARRANTIES OR CONDITIONS OF MERCHANTABILITY AND FITNESS FOR A PARTICULAR PURPOSE. Specifically, except as provided herein, Lake Shore undertakes no responsibility that the products will be fit for any particular purpose for which you may be buying the Products. Any implied warranty is limited in duration to the warranty period. No oral or written information, or advice given by Lake Shore, its agents or employees, shall create a warranty or in any way increase the scope of this limited warranty. Some countries, states or provinces do not allow limitations on an implied warranty, so the above limitation or exclusion might not apply to you. This limited warranty gives you specific legal rights and you might also have other rights that vary from country to country, state to state or province to province.
9. Further, with regard to the United Nations Convention for International Sale of Goods (CISC,) if CISG is found to apply in relation to the goods covered by this limited warranty, which is specifically disclaimed by Lake Shore, then this limited warranty excludes warranties that: (a) the Product is fit for the purpose for which goods of the same description would ordinarily be used, (b) the Product is fit for any particular purpose expressly or impliedly made known to Lake Shore at the time of the purchase of the Product, (c) the Product is contained or packaged in a manner usual for such goods or in a manner adequate to preserve and protect such goods where it is shipped by someone other than a carrier hired by Lake Shore.



10. Lake Shore disclaims any warranties of technological value or of non-infringement with respect to the Product and Lake Shore shall have no duty to defend, indemnify, or hold harmless you from and against any or all damages or costs incurred by you arising from the infringement of patents or trademarks or violation or copyrights by the Product.
11. This limited warranty is not transferrable.
12. EXCEPT TO THE EXTENT PROHIBITED BY APPLICABLE LAW, NEITHER LAKE SHORE NOR ANY OF ITS SUBSIDIARIES, AFFILIATES OR SUPPLIERS WILL BE HELD LIABLE FOR DIRECT, SPECIAL, INCIDENTAL, CONSEQUENTIAL OR OTHER DAMAGES (INCLUDING LOST PROFIT, LOST DATA, OR DOWNTIME COSTS) ARISING OUT OF THE USE, INABILITY TO USE OR RESULT OF USE OF THE PRODUCT, WHETHER BASED IN WARRANTY, CONTRACT, TORT OR OTHER LEGAL THEORY, REGARDLESS WHETHER OR NOT LAKE SHORE HAS BEEN ADVISED OF THE POSSIBILITY OF SUCH DAMAGES. PURCHASER'S USE OF THE PRODUCT IS ENTIRELY AT PURCHASER'S RISK. SOME COUNTRIES, STATES AND PROVINCES DO NOT ALLOW THE EXCLUSION OF LIABILITY FOR INCIDENTAL OR CONSEQUENTIAL DAMAGES, SO THE ABOVE LIMITATION MAY NOT APPLY TO YOU.
13. This limited warranty gives the purchaser specific legal rights, and the purchaser may also have other rights that vary within or between jurisdictions where the Product is purchased and/or used. Some jurisdictions do not allow limitation in certain warranties, and so the above limitations or exclusions of some warranties stated above may not apply to all purchasers.
14. Except to the extent allowed by applicable law, the terms of this limited warranty do not exclude, restrict or modify the mandatory statutory rights applicable to the sale of the Product to you.

## APPLICABLE LAW AND PLACE OF DISPUTE RESOLUTION

Unless otherwise agreed in writing, the terms and conditions contained herein shall be governed by and construed under the laws of the State of Ohio, USA, excluding application of the United Nations Convention for International sale of Goods (CISG) and excluding any rules relating to the conflicts of law provisions in Ohio.

Any and all disputes arising out of this agreement shall be subject to final and binding arbitration with the American Arbitration Association (AAA).

Regarding those transactions relating International trade, rules governing arbitration thereunder shall be in accord with the AAA International Arbitration Rules.

Further, in all arbitrations the arbitrator(s) shall have exclusive authority to resolve all claims covered by this arbitration agreement, including any dispute relating to the interpretation, applicability, enforceability or formation of this arbitration agreement, and including, but not limited to, any claim that all or any part of this arbitration agreement is void or voidable.

In regard to International trade, any issues involving the scope of arbitration of a dispute shall be governed by the substantive law of the Federal Arbitration Act, 9 U.S.C. Section 1 *et seq.*

In regard to domestic US trade, any issues involving the arbitrability of a dispute shall be governed by the substantive law of Ohio, relating to arbitration.

Further, the venue of arbitration shall be in Franklin or Delaware Counties, Ohio U.S.A. The substantive law used for arbitration, or otherwise for all dispute resolution, (other than as is set out above relating to the scope of arbitration) shall be that of Ohio, U.S.A., excluding application of the United Nations Convention for International sale of Goods (CISG) and exclusive of its conflict of laws provisions. The State of Ohio, U.S.A., shall be deemed the place the sale contract is formed.

## Cryogenic Sensors, Instruments, and Accessories

Temperature Sensors

AC Resistance Bridge

Temperature Controllers

Temperature Monitors

Temperature Transmitters

Programmable DC  
Current Source

Superconducting  
Magnet Power Supply

Cryogenic Accessories

Reference Materials



### Lake Shore Cryotronics, Inc.

575 McCorkle Blvd.  
Westerville, OH 43082  
Tel 614-891-2244  
Fax 614-818-1600  
info@lakeshore.com  
[www.lakeshore.com](http://www.lakeshore.com)