

User's Manual
Model 336
Temperature Controller

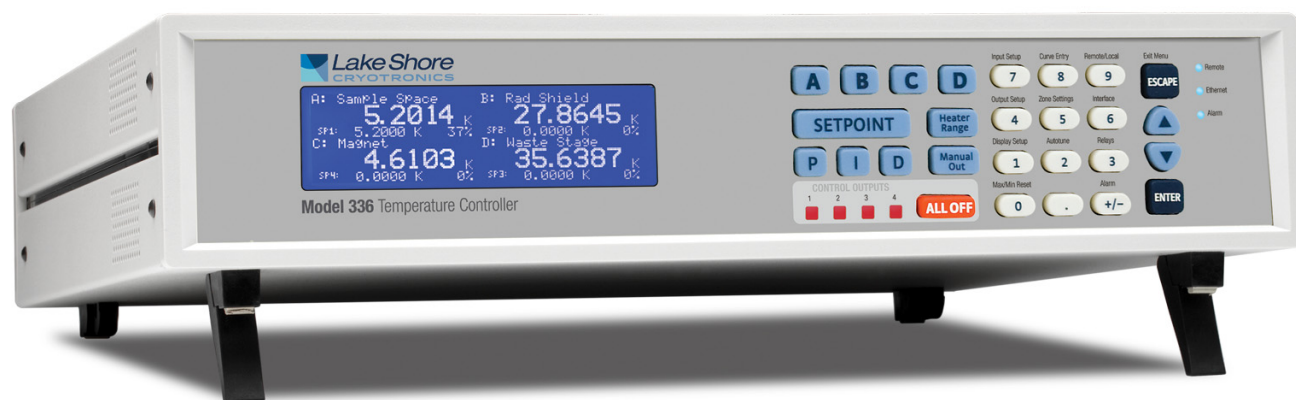

Lake Shore Cryotronics, Inc.
575 McCorkle Blvd.
Westerville, Ohio 43082-8888 USA

sales@lakeshore.com
service@lakeshore.com
www.lakeshore.com

Fax: (614) 891-1392
Telephone: (614) 891-2243

Methods and apparatus disclosed and described herein have been developed solely on company funds of Lake Shore Cryotronics, Inc. No government or other contractual support or relationship whatsoever has existed which in any way affects or mitigates proprietary rights of Lake Shore Cryotronics, Inc. in these developments. Methods and apparatus disclosed herein may be subject to U.S. Patents existing or applied for.

Lake Shore Cryotronics, Inc. reserves the right to add, improve, modify, or withdraw functions, design modifications, or products at any time without notice. Lake Shore shall not be liable for errors contained herein or for incidental or consequential damages in connection with furnishing, performance, or use of this material.

LIMITED WARRANTY STATEMENT

WARRANTY PERIOD: THREE (3) YEARS

1. Lake Shore warrants that products manufactured by Lake Shore (the "Product") will be free from defects in materials and workmanship for three years from the date of Purchaser's physical receipt of the Product (the "Warranty Period"). If Lake Shore receives notice of any such defects during the Warranty Period and the defective Product is shipped freight prepaid back to Lake Shore, Lake Shore will, at its option, either repair or replace the Product (if it is so defective) without charge for parts, service labor or associated customary return shipping cost to the Purchaser. Replacement for the Product may be by either new or equivalent in performance to new. Replacement or repaired parts, or a replaced Product, will be warranted for only the unexpired portion of the original warranty or 90 days (whichever is greater).

2. Lake Shore warrants the Product only if the Product has been sold by an authorized Lake Shore employee, sales representative, dealer or an authorized Lake Shore original equipment manufacturer (OEM).

3. The Product may contain remanufactured parts equivalent to new in performance or may have been subject to incidental use when it is originally sold to the Purchaser.

4. The Warranty Period begins on the date the Product ships from Lake Shore's plant.

5. This limited warranty does not apply to defects in the Product resulting from (a) improper or inadequate installation (unless OT&V services are performed by Lake Shore), maintenance, repair or calibration, (b) fuses, software, power surges, lightning and non-rechargeable batteries, (c) software, interfacing, parts or other supplies not furnished by Lake Shore, (d) unauthorized modification or misuse, (e) operation outside of the published specifications, (f) improper site preparation or site maintenance (g) natural disasters such as flood, fire, wind, or earthquake, or (h) damage during shipment other than original shipment to you if shipped through a Lake Shore carrier.

6. This limited warranty does not cover: (a) regularly scheduled or ordinary and expected recalibrations of the Product; (b) accessories to the Product (such as probe tips and cables, holders, wire, grease, varnish, feedthroughs, etc.); (c) consumables used in conjunction with the Product (such as probe tips and cables, probe holders, sample tails, rods and holders, ceramic putty for mounting samples, Hall sample cards, Hall sample enclosures, etc.); or, (d) non-Lake Shore branded Products that are integrated with the Product.

7. To the extent allowed by applicable law, this limited warranty is the only warranty applicable to the Product and replaces all other warranties or conditions, express or implied, including, but not limited to, the implied warranties or conditions of merchantability and fitness for a particular purpose. Specifically, except as provided herein, Lake Shore undertakes no responsibility that the products will be fit for any particular purpose for which you may be buying the Products.

Any implied warranty is limited in duration to the warranty period. No oral or written information, or advice given by the Company, its Agents or Employees, shall create a warranty or in any way increase the scope of this limited warranty. Some countries, states or provinces do not allow limitations on an implied warranty, so the above limitation or exclusion might not apply to you. This warranty gives you specific legal rights and you might also have other rights that vary from country to country, state to state or province to province.

8. Further, with regard to the United Nations Convention for International Sale of Goods (CISG), if CISG is found to apply in relation to this agreement, which is specifically disclaimed by Lake Shore, then this limited warranty excludes warranties that: (a) the Product is fit for the purpose for which goods of the same description would ordinarily be used, (b) the Product is fit for any particular purpose expressly or impliedly made known to Lake Shore at the time of the conclusion of the contract, (c) the Product is contained or packaged in a manner usual for such goods or in a manner adequate to preserve and protect such goods where it is shipped by someone other than a carrier hired by Lake Shore.

9. Lake Shore disclaims any warranties of technological value or of non-infringement with respect to the Product and Lake Shore shall have no duty to defend, indemnify, or hold harmless you from and against any or all damages or costs incurred by you arising from the infringement of patents or trademarks or violation or copyrights by the Product.

10. THIS WARRANTY IS NOT TRANSFERRABLE. This warranty is not transferrable.

11. Except to the extent prohibited by applicable law, neither Lake Shore nor any of its subsidiaries, affiliates or suppliers will be held liable for direct, special, incidental, consequential or other damages (including lost profit, lost data, or downtime costs) arising out of the use, inability to use or result of use of the product, whether based in warranty, contract, tort or other legal theory, regardless whether or not Lake Shore has been advised of the possibility of such damages. Purchaser's use of the Product is entirely at Purchaser's risk. Some countries, states and provinces do not allow the exclusion of liability for incidental or consequential damages, so the above limitation may not apply to you.

12. This limited warranty gives you specific legal rights, and you may also have other rights that vary within or between jurisdictions where the product is purchased and/or used. Some jurisdictions do not allow limitation in certain warranties, and so the above limitations or exclusions of some warranties stated above may not apply to you.

13. Except to the extent allowed by applicable law, the terms of this limited warranty statement do not exclude, restrict or modify the mandatory statutory rights applicable to the sale of the product to you.

CERTIFICATION

Lake Shore certifies that this product has been inspected and tested in accordance with its published specifications and that this product met its published specifications at the time of shipment. The accuracy and calibration of this product at the time of shipment are traceable to the United States National Institute of Standards and Technology (NIST); formerly known as the National Bureau of Standards (NBS).

FIRMWARE LIMITATIONS

Lake Shore has worked to ensure that the Model 336 firmware is as free of errors as possible, and that the results you obtain from the instrument are accurate and reliable. However, as with any computer-based software, the possibility of errors exists.

In any important research, as when using any laboratory equipment, results should be carefully examined and rechecked before final conclusions are drawn. Neither Lake Shore nor anyone else involved in the creation or production of this firmware can pay for loss of time, inconvenience, loss of use of the product, or property damage caused by this product or its failure to work, or any other incidental or consequential damages. Use of our product implies that you understand the Lake Shore license agreement and statement of limited warranty.

FIRMWARE LICENSE AGREEMENT

The firmware in this instrument is protected by United States copyright law and international treaty provisions. To maintain the warranty, the code contained in the firmware must not be modified. Any changes made to the code is at the user's risk. Lake Shore will assume no responsibility for damage or errors incurred as result of any changes made to the firmware.

FIRMWARE LICENSE AGREEMENT (continued)

Under the terms of this agreement you may only use the Model 336 firmware as physically installed in the instrument. Archival copies are strictly forbidden. You may not decompile, disassemble, or reverse engineer the firmware. If you suspect there are problems with the firmware, return the instrument to Lake Shore for repair under the terms of the Limited Warranty specified above. Any unauthorized duplication or use of the Model 336 firmware in whole or in part, in print, or in any other storage and retrieval system is forbidden.

TRADEMARK ACKNOWLEDGMENT

Many manufacturers and sellers claim designations used to distinguish their products as trademarks. Where those designations appear in this manual and Lake Shore was aware of a trademark claim, they appear with initial capital letters and the TM or [®] symbol. AlumelTM and ChromelTM are trademarks of

Conceptech, Inc., Corporation

ApiezonTM is a registered trademark of M&I Materials, Ltd.

CalCurveTM, CernoxTM, SoftCalTM, RoxTM, Curve HandlerTM are trademarks of Lake Shore Cryotronics, Inc.

JavaTM is a registered trademark of Sun Microsystems, Inc. of Santa Clara, CA

LabVIEW[®] is a registered trademark of National Instruments.

Mac[®] is a registered trademark of Apple, Inc., registered in the U.S and other countries.

Microsoft Windows[®], Excel[®], and Windows Vista[®] are registered trademarks of Microsoft Corporation in the United States and other countries.

Stycast[®] is a trademark of Emerson & Cuming.

WinZipTM is a registered trademark of Nico Mak of Connecticut.

Copyright 2009 - 2017 Lake Shore Cryotronics, Inc. All rights reserved. No portion of this manual may be reproduced, stored in a retrieval system, or transmitted, in any form or by any means, electronic, mechanical, photocopying, recording, or otherwise, without the express written permission of Lake Shore.



EU DECLARATION OF CONFORMITY



This declaration of conformity is issued under the sole responsibility of the manufacturer.

Manufacturer:

Lake Shore Cryotronics, Inc.
575 McCorkle Boulevard
Westerville, OH 43082
USA

Object of the declaration:

Model(s): 336
Description: Cryogenic Temperature Controller

The object of the declaration described above is in conformity with the relevant Union harmonization legislation:

2014/35/EU Low Voltage Directive
2014/30/EU EMC Directive
2011/65/EU RoHS Directive

References to the relevant harmonized standards used to the specification in relation to which conformity is declared:

EN 61010-1:2010
Overvoltage Category II
Pollution Degree 2

EN 61326-1:2013
Class A
Controlled Electromagnetic Environment

EN 50581:2012

Signed for and on behalf of:

Place, Date:
Westerville, OH USA
29-SEP-2016

Scott Ayer
Director of Quality & Compliance

Electromagnetic Compatibility (EMC) for the Model 336 Temperature Controller

Electromagnetic Compatibility (EMC) of electronic equipment is a growing concern worldwide. Emissions of and immunity to electromagnetic interference is now part of the design and manufacture of most electronics. To qualify for the CE Mark, the Model 336 meets or exceeds the requirements of the European EMC Directive 89/336/EEC as a CLASS A product. A Class A product is allowed to radiate more RF than a Class B product and must include the following warning:

WARNING:This is a Class A product. In a domestic environment, this product may cause radio interference in which case the user may be required to take adequate measures.

The instrument was tested under normal operating conditions with sensor and interface cables attached. If the installation and operating instructions in the User's Manual are followed, there should be no degradation in EMC performance.

This instrument is not intended for use in close proximity to RF Transmitters such as two-way radios and cell phones. Exposure to RF interference greater than that found in a typical laboratory environment may disturb the sensitive measurement circuitry of the instrument.

Pay special attention to instrument cabling. Improperly installed cabling may defeat even the best EMC protection. For the best performance from any precision instrument, follow the grounding and shielding instructions in the User's Manual. In addition, the installer of the Model 336 should consider the following:

- Shield measurement and computer interface cables.
- Leave no unused or unterminated cables attached to the instrument.
- Make cable runs as short and direct as possible. Higher radiated emissions are possible with long cables.
- Do not tightly bundle cables that carry different types of signals.

Table of Contents

Chapter 1 Introduction

1.1	Product Description	1
1.1.1	Sensor Inputs	2
1.1.2	Temperature Control	2
1.1.3	Interface	3
1.1.4	Configurable Display	4
1.1.5	Three Option Cards	4
1.2	Sensor Selection	4
1.3	Model 336 Specifications	7
1.3.1	Input Specifications	7
1.3.2	Sensor Input Configuration	8
1.3.3	Thermometry	8
1.3.4	Control	9
1.3.4.1	Heater Outputs (Outputs 1 and 2)	9
1.3.4.2	Unpowered Analog Outputs (Outputs 3 and 4)	10
1.3.5	Front Panel	10
1.3.6	Interface	11
1.3.7	General	11
1.4	Safety Summary and Symbols	12

Chapter 2 Cooling System Design and Temperature Control

2.1	General	15
2.2	Temperature Sensor Selection	15
2.2.1	Temperature Range	15
2.2.2	Sensor Sensitivity	15
2.2.3	Environmental Conditions	16
2.2.4	Measurement Accuracy	16
2.2.5	Sensor Package	16
2.3	Sensor Calibrations	16
2.3.1	Precision Calibration	17
2.3.2	SoftCal™	17
2.3.3	Sensors Using Standard Curves	17
2.3.4	Curve Handler™	17
2.4	Sensor Installation	18
2.4.1	Mounting Materials	18
2.4.2	Sensor Location	18
2.4.3	Thermal Conductivity	18
2.4.4	Contact Area	19
2.4.5	Contact Pressure	19
2.4.6	Lead Wire	19
2.4.7	Lead Soldering	20
2.4.8	Thermal Anchoring Leads	20
2.4.9	Thermal Radiation	20
2.5	Heater Selection and Installation	21
2.5.1	Heater Resistance and Power	21
2.5.2	Heater Location	22
2.5.3	Heater Types	22
2.5.4	Heater Wiring	22
2.6	Consideration for Good Control	23
2.6.1	Thermal Conductivity	23
2.6.2	Thermal Lag	23
2.6.3	Two-Sensor Approach	23
2.6.4	Thermal Mass	23

2.6.5	System Non-Linearity.....	23
2.7	PID Control	24
2.7.1	Proportional (P)	24
2.7.2	Integral (I)	24
2.7.3	Derivative (D).....	25
2.7.4	Manual Output.....	25
2.8	Manual Tuning	27
2.8.1	Setting Heater Range	27
2.8.2	Tuning Proportional	27
2.8.3	Tuning Integral.....	28
2.8.4	Tuning Derivative	29
2.9	Autotuning	29
2.10	Zone Tuning	30
2.11	Thermoelectric Devices	30

Chapter 3 Installation

3.1	General	31
3.2	Inspection and Unpacking	31
3.3	Rear Panel Definition	31
3.4	Line Input Assembly	32
3.4.1	Line Voltage	32
3.4.2	Line Fuse and Fuse Holder	32
3.4.3	Power Cord	33
3.4.4	Power Switch	33
3.5	Diode/Resistor Sensor Inputs	33
3.5.1	Sensor Input Connector and Pinout	33
3.5.2	Sensor Lead Cable	34
3.5.3	Grounding and Shielding Sensor Leads	34
3.5.4	Sensor Polarity	34
3.5.5	Four-Lead Sensor Measurement	35
3.5.6	Two-Lead Sensor Measurement	35
3.5.7	Lowering Measurement Noise	36
3.6	Capacitance Sensor Inputs (Model 3061)	36
3.6.1	Wiring, Guarding and Shielding	37
3.7	Thermocouple Sensor Inputs (Thermocouple Model 3060)	37
3.7.1	Sensor Input Terminals	37
3.7.2	Thermocouple Installation	38
3.7.3	Grounding and Shielding	38
3.8	Heater Output Setup	38
3.8.1	Heater Output Description	38
3.8.2	Heater Output Connectors	39
3.8.3	Heater Output Wiring	39
3.8.4	Heater Output Noise	39
3.8.5	Powering Outputs 3 and 4 Using an External Power Supply	39
3.8.5.1	Choosing a Power Supply	40
3.8.5.2	Power Supply Setup	40
3.8.5.3	Connecting to the Model 336	41
3.8.5.4	Programming Voltages Under 10 V	41

Chapter 4 Operation

4.1	General	43
4.1.1	Understanding Menu Navigation	43
4.2	Front Panel Description	44
4.2.1	Keypad Definitions	44
4.2.1.1	Direct Operation Keys	44
4.2.1.2	Menu/Number Pad Keys	45
4.2.2	Annunciators	45
4.2.3	General Keypad Operation	46
4.3	Display Setup	47

4.3.1	Display Modes	47
4.3.1.1	Four Loop Mode	47
4.3.1.2	All Inputs Mode	48
4.3.1.3	Input Display Modes	48
4.3.1.4	Custom Display Mode	49
4.3.2	Display Contrast	51
4.4	Input Setup	51
4.4.1	Diode Sensor Input Setup	52
4.4.2	Positive Temperature Coefficient (PTC) Resistor Sensor Input Setup	52
4.4.3	Negative Temperature Coefficient (NTC) Resistor Sensor Input Setup	52
4.4.4	Range Selection	52
4.4.5	Thermal Electromotive Force (EMF) Compensation	53
4.4.6	Thermocouple Sensor Input Setup (Model 3060 Only)	54
4.4.6.1	Internal Room Temperature Compensation	54
4.4.6.2	Internal Room Temperature Compensation Calibration Procedure	54
4.4.7	Capacitance Sensor Input Setup (Model 3061 Only)	55
4.4.7.1	Range Selection	55
4.4.7.2	Temperature Coefficient Selection	56
4.4.7.3	Control Channel Changes	56
4.4.8	4-Channel Scanner Input Setup (Model 3062 Only)	56
4.4.8.1	Type and Range Selection	56
4.4.8.2	Update Rate	57
4.4.9	Curve Selection	57
4.4.10	Filter	58
4.4.11	Input Name	60
4.4.12	Temperature Limit	60
4.4.13	Preferred Units	60
4.4.14	Max/Min	60
4.5	Output and Control Setup	60
4.5.1	Heater Outputs	61
4.5.1.1	Max Current and Heater Resistance	61
4.5.1.1.1	User Max Current	61
4.5.1.2	Power Up Enable	63
4.5.1.3	Heater Out Display	63
4.5.1.4	Output Modes	63
4.5.1.4.1	Closed Loop PID Mode	63
4.5.1.4.2	Zone Mode	64
4.5.1.4.3	Open Loop Mode	64
4.5.1.5	Control Parameters	64
4.5.1.5.1	Control Input	65
4.5.1.5.2	Proportional (P)	65
4.5.1.5.3	Integral (I)	65
4.5.1.5.4	Derivative (D)	66
4.5.1.5.5	Manual Output	66
4.5.1.5.6	Setpoint	67
4.5.1.5.7	Setpoint Ramping	68
4.5.1.5.8	Heater Range	69
4.5.1.5.9	ALL OFF	70
4.5.2	Unpowered Analog Outputs	70
4.5.2.1	Warm Up Supply	70
4.5.2.2	Monitor Out	70
4.6	Interface	70
4.6.1	USB	70
4.6.2	Ethernet	71
4.6.3	IEEE-488	71
4.6.3.1	Remote/Local	71
4.7	Locking and Unlocking the Keypad	71

Chapter 5 Advanced Operation

5.1	General	73
5.2	Autotune	73
5.3	Zone Settings	75
5.4	Bipolar Control	77
5.5	Warm Up Supply	77
5.5.1	Warm Up Percentage	77
5.5.2	Warm Up Control	78
5.6	Monitor Out	78
5.6.1	Monitor Units	78
5.6.1.1	Polarity and Monitor Out Scaling Parameters	79
5.7	Alarms and Relays	80
5.7.1	Alarms	80
5.7.1.1	Alarm Annunciators	80
5.7.1.2	Alarm Latching	80
5.7.2	Relays	82
5.8	Curve Numbers and Storage	82
5.8.1	Curve Header Parameters	83
5.8.2	Curve Breakpoints	83
5.9	Front Panel Curve Entry Operations	84
5.9.1	Edit Curve	84
5.9.1.1	Edit a Breakpoint Pair	85
5.9.1.2	Add a New Breakpoint Pair	86
5.9.1.3	Delete a Breakpoint Pair	86
5.9.1.4	Thermocouple Curve Considerations	86
5.9.2	View Curve	87
5.9.3	Erase Curve	87
5.9.4	Copy Curve	87
5.10	SoftCal™	88
5.10.1	SoftCal™ With Silicon Diode Sensors	88
5.10.2	SoftCal™ Accuracy With DT-400 Series Silicon Diode Sensors	89
5.10.3	SoftCal™ With Platinum Sensors	90
5.10.4	SoftCal™ Accuracy With Platinum Sensors	90
5.10.5	SoftCal™ Calibration Curve Creation	91

Chapter 6 Computer Interface Operation

6.1	General	93
6.2	IEEE-488 Interface	93
6.2.1	Changing IEEE-488 Interface Parameters	94
6.2.2	Remote/Local Operation	94
6.2.3	IEEE-488.2 Command Structure	94
6.2.3.1	Bus Control Commands	94
6.2.3.2	Common Commands	95
6.2.3.3	Device Specific Commands	95
6.2.3.4	Message Strings	95
6.2.4	Status System Overview	96
6.2.4.1	Condition Registers	96
6.2.4.2	Event Registers	96
6.2.4.3	Enable Registers	96
6.2.4.4	Status Byte Register	98
6.2.4.5	Service Request Enable Register	98
6.2.4.6	Reading Registers	98
6.2.4.7	Programming Registers	98
6.2.4.8	Clearing Registers	99
6.2.5	Status System Detail: Status Register Sets	99
6.2.5.1	Standard Event Status Register Set	99
6.2.5.2	Operation Event Register Set	100
6.2.6	Status System Detail: Status Byte Register and Service Request	101
6.2.6.1	Status Byte Register	101

6.2.6.2	Service Request Enable Register	102
6.2.6.3	Using Service Request (SRQ) and Serial Poll	102
6.2.6.4	Using Status Byte Query (*STB?)	103
6.2.6.5	Using the Message Available (MAV) Bit	103
6.2.6.6	Using Operation Complete (*OPC) and Operation Complete Query (*OPC?)	103
6.3	USB Interface	104
6.3.1	Physical Connection	104
6.3.2	Hardware Support	104
6.3.3	Installing the USB Driver	104
6.3.3.1	Installing the Driver From Windows® Update in Windows 7 and Vista®	104
6.3.3.2	Installing the Driver From Windows® Update in Windows® XP ...	105
6.3.3.3	Installing the Driver From the Web	105
6.3.3.3.1	Download the driver:	105
6.3.3.3.2	Extract the driver:	105
6.3.3.3.3	Manually install the driver	106
6.3.3.4	Installing the USB Driver from the Included CD	107
6.3.4	Communication	107
6.3.4.1	Character Format	108
6.3.4.2	Message Strings	108
6.3.5	Message Flow Control	108
6.4	Ethernet Interface	109
6.4.1	Ethernet Configuration	109
6.4.1.1	Network Address Parameters	109
6.4.1.2	Network Addresss Configuration Methods	110
6.4.1.3	DNS Parameters	111
6.4.2	Viewing Ethernet Configuration	113
6.4.2.1	LAN Status	113
6.4.2.2	MAC Address	114
6.4.2.3	Viewing Network Configuration Parameters and DNS Parameters	114
6.4.3	TCP Socket Communication	114
6.4.4	Embedded Web Interface	115
6.4.4.1	Connecting to the Web Interface	115
6.4.4.2	Web Pages	115
6.5	Utilities	117
6.5.1	Embedded Curve Handler™	117
6.5.2	Ethernet Firmware Updater	118
6.5.3	Instrument Configuration Backup Utility	119
6.5.4	Embedded Chart Recorder	120
6.5.4.1	Configuration Panel	120
6.5.4.2	Starting Data Acquisition	121
6.5.4.3	Chart Functionality	121
6.5.4.4	Utilities Panel	121
6.5.4.5	Menu	122
6.5.4.6	Information	122
6.6	Command Summary	123
6.6.1	Interface Commands	125
7.1	General	147
7.2	Models	147
7.3	Options	147
7.4	Accessories	147
7.5	Rack Mounting	149
7.6	Input Option Card Installation	149

Chapter 7 Options and Accessories

Chapter 8 Service

8.1	General	153
8.2	USB Troubleshooting	153
8.2.1	New Installation	153
8.2.2	Existing Installation No Longer Working	153
8.2.3	Intermittent Lockups	153
8.3	IEEE Interface Troubleshooting	154
8.3.1	New Installation	154
8.3.2	Existing Installation No Longer Working	154
8.3.3	Intermittent Lockups	154
8.4	Fuse Drawer	154
8.5	Line Voltage Selection	154
8.6	Fuse Replacement	155
8.7	Factory Reset Menu	155
8.7.1	Default Values	156
8.7.2	Product Information	157
8.8	Error Messages	157
8.9	Calibration Procedure	157
8.10	Rear Panel Connector Definition	158
8.10.1	IEEE-488 Interface Connector	160
8.11	Electrostatic Discharge	161
8.11.1	Identification of Electrostatic Discharge Sensitive Components	161
8.11.2	Handling Electrostatic Discharge Sensitive Components	162
8.12	Enclosure Top Remove and Replace Procedure	162
8.13	Firmware Updates	164
8.13.1	Updating the Firmware	164
8.13.2	Record of Updates Made to the Firmware	164
8.14	Technical Inquiries	164
8.14.1	Contacting Lake Shore	164
8.14.2	Return of Equipment	165
8.14.3	RMA Valid Period	165
8.14.4	Shipping Charges	165
8.14.5	Restocking Fee	165

Appendix A Temperature Scales

A.1	Definition	167
A.2	Comparison	167
A.3	Conversions	167

Appendix B Handling Liquid Helium and Nitrogen

B.1	General	169
B.2	Properties	169
B.3	Handling Cryogenic Storage Dewars	169
B.4	Liquid Helium and Nitrogen Safety Precautions	169
B.5	Recommended First Aid	170

Appendix C Curve Tables

C.1	General	171
-----	---------	-----

Chapter 1: Introduction

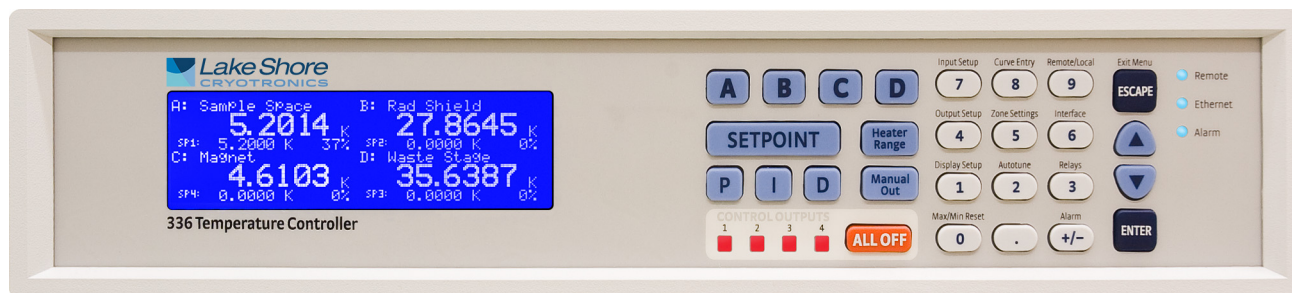

FIGURE 1-1 Model 336 front view

1.1 Product Description

Features:

- Operates down to 300 mK with appropriate NTC RTD sensors
- Four sensor inputs and four independent control outputs
- Two PID control loops: 100 W and 50 W into a 50 Ω or 25 Ω load
- Autotuning automatically collects PID parameters
- Automatically switch sensor inputs using zones to allow continuous measurement and control from 300 mK to 1505 K
- Custom display setup allows you to label each sensor input
- Ethernet, USB, and IEEE-488 interfaces
- Supports diode, RTD, and thermocouple temperature sensors
- Sensor excitation current reversal eliminates thermal EMF errors for resistance sensors
- ± 10 V analog voltage outputs, alarms, and relays

The first of a new generation of innovative temperature measurement and control solutions by Lake Shore, the Model 336 temperature controller comes standard equipped with many advanced features promised to deliver the functionality and reliable service you've come to expect from the world leader in cryogenic thermometry. The Model 336 is the only temperature controller available with four sensor inputs, four control outputs, and 150 W of low noise heater power. Two independent heater outputs providing 100 W and 50 W can be associated with any of the four sensor inputs and programmed for closed loop temperature control in proportional-integral-derivative (PID) mode. The improved autotuning feature of the Model 336 can be used to automatically collect PID parameters, so you spend less time tuning your controller and more time conducting experiments.

The Model 336 supports the industry's most advanced line of cryogenic temperature sensors as manufactured by Lake Shore, including diodes, resistance temperature detectors (RTDs) and thermocouples. The controller's zone tuning feature allows you to measure and control temperatures seamlessly from 300 mK to over 1,500 K by automatically switching temperature sensor inputs when your temperature range goes beyond the usable range of a given sensor. You'll never again have to be concerned with temperature sensor over or under errors and measurement continuity issues. Alarms, relays, and ± 10 V analog voltage outputs are available to help automate secondary control functions.

Another innovative first from Lake Shore, the ability to custom label sensor inputs eliminates the guesswork in remembering or determining the location to which a sensor input is associated. As we strive to maintain increasingly demanding workloads, ease of use and the ability to stay connected from anywhere in the world are critical attributes. With standard Ethernet, USB, and IEEE-488 interfaces and an intuitive menu structure and logic, the Model 336 was designed with efficiency, reliable connectivity, and ease of use in mind. While you may need to leave your lab, Ethernet ensures you'll always be connected to your experiments. The new intuitive front panel layout and keypad logic, bright graphic display, and LED indicators enhance the user friendly front panel interface of the Model 336.

In many applications, the unparalleled feature set of the Model 336 allows you to replace several instruments with one, saving time, money and valuable laboratory space. Delivering more feedback, tighter control, and faster cycle times, the Model 336 keeps up with increasingly complex temperature measurement and control applications. It is the ideal solution for general purpose to advanced laboratory applications. Put the Model 336 temperature controller to use in your lab and let it take control of your measurement environment.

1.1.1 Sensor Inputs

The Model 336 offers 4 standard sensor inputs that are compatible with diode and RTD temperature sensors. The field installable Model 3060 thermocouple input option provides support for up to two thermocouple inputs by adding thermocouple functionality to inputs C and D.

Sensor inputs feature a high-resolution 24-bit analog-to-digital converter; each input has its own current source, providing fast settling times. All four sensor inputs are optically isolated from other circuits to reduce noise and to provide repeatable sensor measurements. Current reversal eliminates thermal electromotive force (EMF) errors in resistance sensors. Nine excitation currents facilitate temperature measurement and control down to 300 mK using appropriate negative temperature coefficient (NTC) RTDs. Autorange mode automatically scales excitation current in NTC RTDs to reduce self heating at low temperatures as sensor resistance changes by many orders of magnitude. Temperatures down to 1.4 K can be measured and controlled using silicon or GaAlAs diodes. Software selects the appropriate excitation current and signal gain levels when the sensor type is entered via the instrument front panel. The unique zone setting feature automatically switches sensor inputs, enabling you to measure temperatures from 300 mK to over 1,500 K without interrupting your experiment.

The Model 336 includes standard temperature sensor response curves for silicon diodes, platinum RTDs, ruthenium oxide RTDs, and thermocouples. Non-volatile memory can also store up to 39 200-point CalCurves for Lake Shore calibrated temperature sensors or user curves. A built-in SoftCal™ algorithm can be used to generate curves for silicon diodes and platinum RTDs that can be stored as user curves. Temperature sensor calibration data can be easily uploaded and manipulated using the Lake Shore curve handler software.

1.1.2 Temperature Control

Providing a total of 150 W of heater power, the Model 336 is the most powerful temperature controller available. Delivering very clean heater power, it precisely controls temperature throughout the full scale temperature range for excellent measurement reliability, efficiency, and throughput. Two independent PID control outputs supplying 100 W and 50 W of heater power can be associated with any of the four standard sensor inputs. Precise control output is calculated based on your temperature set-point and feedback from the control sensor. Wide tuning parameters accommodate most cryogenic cooling systems and many high-temperature ovens commonly used in laboratories. PID values can be manually set for fine control, or the improved

autotuning feature can automate the tuning process. Autotune collects PID parameters and provides information to help build zone tables. The setpoint ramp feature provides smooth, continuous setpoint changes and predictable setpoint approaches without the worry of overshoot or excessive settling times. When combined with the zone setting feature, which enables automatic switching of sensor inputs and scales current excitation through 10 different preloaded temperature zones, the Model 336 provides continuous measurement and control from 300 mK to 1505 K.

Control outputs 1 and 2 are variable DC current sources referenced to chassis ground. Output 1 can provide 100 W of continuous power to a 25 Ω load or 50 W to a 50 Ω or 25 Ω load. Output 2 provides 50 W to 25 Ω or 50 Ω heater loads. Outputs 3 and 4 are variable DC voltage source outputs providing two ± 10 V analog outputs. When not in use to extend the temperature controller heater power, these outputs can function as manually controlled voltage sources.

Temperature limit settings for inputs are provided as a safeguard against system damage. Each input is assigned a temperature limit, and if any input exceeds that limit, all control channels are automatically disabled.

1.1.3 Interface

The Model 336 is standard equipped with Ethernet, universal serial bus (USB) and parallel (IEEE-488) interfaces. In addition to gathering data, nearly every function of the instrument can be controlled through a computer interface. You can download the Lake Shore curve handler software to your computer to easily enter and manipulate sensor calibration curves for storage in the instrument's non-volatile memory.

Ethernet provides the ability to access and monitor instrument activities via the internet from anywhere in the world. The USB interface emulates an RS-232 serial port at a fixed 57,600 baud rate, but with the physical plug-ins of a USB. It also allows you to download firmware upgrades, ensuring the most current firmware version is loaded into your instrument without having to physically change anything.

Each sensor input has a high and low alarm that offer latching and non-latching operation. The 2 relays can be used in conjunction with the alarms to alert you of a fault condition and perform simple on/off control. Relays can be assigned to any alarm or operated manually.

The ± 10 V analog voltage outputs on outputs 3 and 4 can be configured to send a voltage proportional to temperature to a strip chart recorder or data acquisition system. You may select the scale and data sent to the output, including temperature or sensor units.

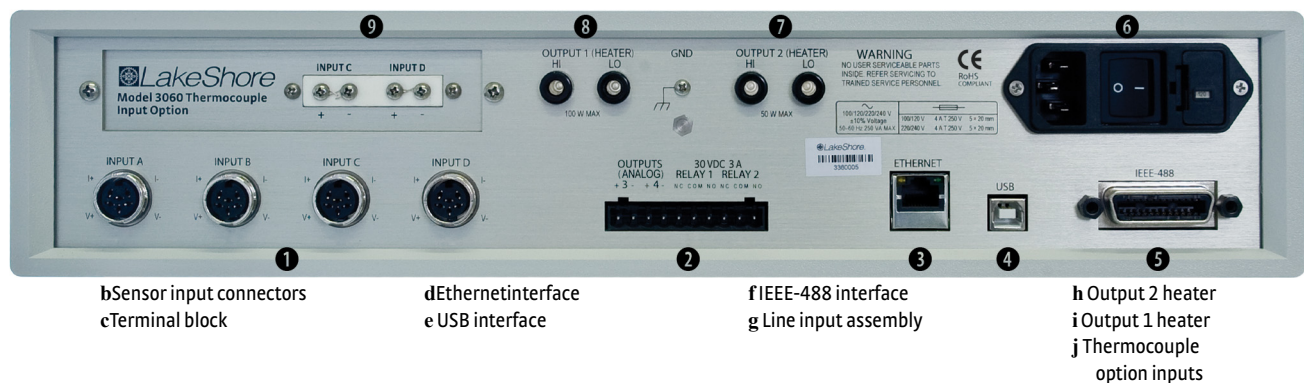

FIGURE 1-2 Model 336 rear panel

1.1.4 Configurable Display

The Model 336 offers a bright, graphic liquid crystal display with an LED backlight that simultaneously displays up to 8 readings. You can show all 4 loops, or if you need to monitor 1 input, you can display just that one in greater detail. Or you can custom configure each display location to suit your experiment. Data from any input can be assigned to any of the locations, and your choice of temperature or sensor units can be displayed. For added convenience, you can also custom label each sensor input, eliminating the guesswork in remembering or determining the location to which a sensor input is associated.



FIGURE 1-3 Displays showing four loop mode, input display mode and custom display mode

1.1.5 Three Option Cards

Field installable input option cards can expand your sensor selection to include silicon diodes (like DT-670), capacitance sensors or thermocouples. Once installed, the option input can be selected and named from the front panel like any other input type. These option cards further expand the application versatility of the Model 336 temperature controller by allowing specialized sensors to be switched in and out to achieve specific measurement objectives.

For example, addition of the thermocouple input option enables continuous measurement to 1000 K and above. Alternatively, the capacitance sensor option card enables a magnetics-impervious capacitance temperature sensor to be temporarily switched in for elimination of magneto-resistive effects while taking low temperature sample measurements under high or changing fields. The 4-channel scanner option card enables use of additional sensors for supplemental monitoring.

1.2 Sensor Selection

Silicon diodes are the best choice for general cryogenic use from 1.4 K to above room temperature. Diodes are economical to use because they follow a standard curve and are interchangeable in many applications. They are not suitable for use in ionizing radiation or magnetic fields.

Cernox™ thin-film RTDs offer high sensitivity and low magnetic field-induced errors over the 0.3 K to 420 K temperature range. Cernox sensors require calibration.

Platinum RTDs offer high uniform sensitivity from 30 K to over 800 K. With excellent reproducibility, they are useful as thermometry standards. They follow a standard curve above 70 K and are interchangeable in many applications.

		Model	Useful Range	Magnetic Field Use
Diodes (3062)	Silicon Diode	DT-670-SD	1.4 K to 500 K	$T \geq 60 \text{ K} \ \& \ B \leq 3 \text{ T}$
	Silicon Diode	DT-670E-BR	30 K to 500 K	$T \geq 60 \text{ K} \ \& \ B \leq 3 \text{ T}$
	Silicon Diode	DT-414	1.4 K to 375 K	$T \geq 60 \text{ K} \ \& \ B \leq 3 \text{ T}$
	Silicon Diode	DT-421	1.4 K to 325 K	$T \geq 60 \text{ K} \ \& \ B \leq 3 \text{ T}$
	Silicon Diode	DT-470-SD	1.4 K to 500 K	$T \geq 60 \text{ K} \ \& \ B \leq 3 \text{ T}$
	Silicon Diode	DT-471-SD	10 K to 500 K	$T \geq 60 \text{ K} \ \& \ B \leq 3 \text{ T}$
	GaAlAs Diode	TG-120-P	1.4 K to 325 K	$T > 4.2 \text{ K} \ \& \ B \leq 5 \text{ T}$
	GaAlAs Diode	TG-120-PL	1.4 K to 325 K	$T > 4.2 \text{ K} \ \& \ B \leq 5 \text{ T}$
	GaAlAs Diode	TG-120-SD	1.4 K to 500 K	$T > 4.2 \text{ K} \ \& \ B \leq 5 \text{ T}$
Positive Temperature Coefficient RTDs	100 Ω Platinum	PT-102/3	14 K to 873 K	$T > 40 \text{ K} \ \& \ B \leq 2.5 \text{ T}$
	100 Ω Platinum	PT-111	14 K to 673 K	$T > 40 \text{ K} \ \& \ B \leq 2.5 \text{ T}$
	Rhodium-Iron	RF-800-4	1.4 K to 500 K	$T > 77 \text{ K} \ \& \ B \leq 8 \text{ T}$
	Rhodium-Iron	RF-100T/U	1.4 K to 325 K	$T > 77 \text{ K} \ \& \ B \leq 8 \text{ T}$
Negative Temperature Coefficient RTDs	Cernox™	CX-1010	0.3 K to 325 K ¹	$T > 2 \text{ K} \ \& \ B \leq 19 \text{ T}$
	Cernox™	CX-1030-HT	0.3 K to 420 K ^{1,3}	$T > 2 \text{ K} \ \& \ B \leq 19 \text{ T}$
	Cernox™	CX-1050-HT	1.4 K to 420 K ¹	$T > 2 \text{ K} \ \& \ B \leq 19 \text{ T}$
	Cernox™	CX-1070-HT	4 K to 420 K ¹	$T > 2 \text{ K} \ \& \ B \leq 19 \text{ T}$
	Cernox™	CX-1080-HT	20 K to 420 K ¹	$T > 2 \text{ K} \ \& \ B \leq 19 \text{ T}$
	Germanium	GR-200A-100	0.3 K to 100 K	Not recommended
	Germanium	GR-200A-250	0.5 K to 100 K	Not recommended
	Germanium	GR-200A/B-500	1.4 K to 100 K	Not recommended
	Germanium	GR-200A/B-1000	1.4 K to 100 K	Not recommended
	Germanium	GR-200A/B-1500	1.4 K to 100 K	Not recommended
	Germanium	GR-200A/B-2500	1.4 K to 100 K	Not recommended
	Carbon-Glass	CGR-1-500	1.4 K to 325 K	$T > 2 \text{ K} \ \& \ B \leq 19 \text{ T}$
	Carbon-Glass	CGR-1-1000	1.7 K to 325 K ²	$T > 2 \text{ K} \ \& \ B \leq 19 \text{ T}$
	Carbon-Glass	CGR-1-2000	2 K to 325 K ²	$T > 2 \text{ K} \ \& \ B \leq 19 \text{ T}$
	Rox™	RX-102	0.3 K to 40 K ³	$T > 2 \text{ K} \ \& \ B \leq 10 \text{ T}$
	Rox™	RX-103	1.4 K to 40 K	$T > 2 \text{ K} \ \& \ B \leq 10 \text{ T}$
Rox™	RX-202	0.3 K to 40 K ³	$T > 2 \text{ K} \ \& \ B \leq 10 \text{ T}$	
Capacitance 3061		CS-501	1.4 K to 290 K	$T > 4.2 \text{ K} \ \& \ B \leq 18.7 \text{ T}$
Thermocouples 3060	Type K	9006-006	3.2 K to 1505 K	Not recommended
	Type E	9006-004	3.2 K to 934 K	Not recommended
	Chromel-AuFe 0.07%	9006-002	1.2 K to 610 K	Not recommended

¹ Non-HT version maximum temperature: 325 K

² Low temperature limited by input resistance range

³ Low temperature specified with self-heating error: $\leq 5 \text{ mK}$

TABLE 1-1 Sensor temperature range

	Example Lake Shore Sensor	Temperature	Nominal Resistance/Voltage	Typical Sensor Sensitivity ⁴	Measurement Resolution: Temperature Equivalents	Electronic Accuracy: Temperature Equivalents	Temperature Accuracy including Electronic Accuracy, CalCurve and Calibrated Sensor	Electronic Control Stability ⁵ : Temperature Equivalents
Silicon Diode	DT-670-CO-13 with 1.4H calibration	1.4 K	1.664 V	-12.49 mV/K	0.8 mK	±13 mK	±25 mK	±1.6 mK
		77 K	1.028 V	-1.73 mV/K	5.8 mK	±76 mK	±98 mK	±11.6 mK
		300 K	0.5597 V	-2.3 mV/K	4.4 mK	±47 mK	±79 mK	±8.8 mK
		500 K	0.0907 V	-2.12 mV/K	4.7 mK	±40 mK	±90 mK	±9.4 mK
Silicon Diode	DT-470-SD-13 with 1.4H calibration	1.4 K	1.6981 V	-13.1 mV/K	0.8 mK	±13 mK	±25 mK	±1.6 mK
		77 K	1.0203 V	-1.92 mV/K	5.2 mK	±69 mK	±91 mK	±10.4 mK
		300 K	0.5189 V	-2.4 mV/K	4.2 mK	±45 mK	±77 mK	±8.4 mK
		475 K	0.0906 V	-2.22 mV/K	4.5 mK	±38 mK	±88 mK	±9 mK
GaAlAs Diode	TG-120-SD with 1.4H calibration	1.4 K	5.391 V	-97.5 mV/K	0.2 mK	±7 mK	±19 mK	±0.4 mK
		77 K	1.422 V	-1.24 mV/K	16 mK	±180 mK	±202 mK	±32 mK
		300 K	0.8978 V	-2.85 mV/K	7 mK	±60 mK	±92 mK	±14 mK
		475 K	0.3778 V	-3.15 mV/K	6.4 mK	±38 mK	±88 mK	±13 mK
100 Ω Platinum RTD 500 Ω Full Scale	PT-103 with 14J calibration	30 K	3.660 Ω	0.191 Ω/K	1.1 mK	±13 mK	±23 mK	±2.2 mK
		77 K	20.38 Ω	0.423 Ω/K	0.5 mK	±10 mK	±22 mK	±1.0 mK
		300 K	110.35 Ω	0.387 Ω/K	5.2 mK	±39 mK	±62 mK	±10.4 mK
		500 K	185.668 Ω	0.378 Ω/K	5.3 mK	±60 mK	±106 mK	±10.6 mK
Cernox™	CX-1010-SD with 0.3L calibration	0.3 K	2322.4 Ω	-10785 Ω/K	8.5 μK	±0.1 mK	±3.6 mK	±17 μK
		0.5 K	1248.2 Ω	-2665.2 Ω/K	26 μK	±0.2 mK	±4.7 mK	±52 μK
		4.2 K	277.32 Ω	-32.209 Ω/K	140 μK	±3.8 mK	±8.8 mK	±280 μK
		300 K	30.392 Ω	-0.0654 Ω/K	23 mK	±339 mK	±414 mK	±46 mK
Cernox™	CX-1050-SD-HT ⁶ with 1.4M calibration	1.4 K	26566 Ω	-48449 Ω/K	20 μK	±0.3 mK	±5.3 mK	±40 μK
		4.2 K	3507.2 Ω	-1120.8 Ω/K	196 μK	±2.1 mK	±7.1 mK	±392 μK
		77 K	205.67 Ω	-2.4116 Ω/K	1.9 mK	±38 mK	±54 mK	±3.8 mK
		420 K	45.03 Ω	-0.0829 Ω/K	18 mK	±338 mK	±403 mK	±36 mK
Germanium	GR-300-AA with 0.3D calibration	0.35 K	18225 Ω	-193453 Ω/K	4 μK	±48 μK	±4.2 mK	±8 μK
		1.4 K	449 Ω	-581 Ω/K	41 μK	±481 μK	±4.7 mK	±82 μK
		4.2 K	94 Ω	-26.6 Ω/K	56 μK	±1.8 mK	±6.8 mK	±112 μK
		100 K	2.7 Ω	-0.024 Ω/K	6.3 mK	±152 mK	±175 mK	±12.6 mK
Germanium	GR-1400-AA with 1.4D calibration	1.8 K	15288 Ω	-26868 Ω/K	28 μK	±302 μK	±4.5 mK	±56 μK
		4.2 K	1689 Ω	-862 Ω/K	91 μK	±900 μK	±5.1 mK	±182 μK
		10 K	253 Ω	-62.0 Ω/K	73 μK	±1.8 mK	±6.8 mK	±146 μK
		100 K	2.8 Ω	-0.021 Ω/K	7.1 mK	±177 mK	±200 mK	±14.2 mK
Carbon-Glass	CGR-1-500 with 1.4L calibration	1.4 K	103900 Ω	-520000 Ω/K	13 μK	±0.1 mK	±4.1 mK	±26 μK
		4.2 K	584.6 Ω	-422.3 Ω/K	63 μK	±0.8 mK	±4.8 mK	±126 μK
		77 K	14.33 Ω	-0.098 Ω/K	4.6 mK	±108 mK	±133 mK	±9.2 mK
		300 K	8.55 Ω	-0.0094 Ω/K	16 mK	±760 mK	±865 mK	±32 mK
Rox™	RX-102A-AA with 0.3B calibration	0.5 K	3701 Ω	-5478 Ω/K	41 μK	±0.5 mK	±5 mK	±82 μK
		1.4 K	2005 Ω	-667 Ω/K	128 μK	±1.4 mK	±6.4 mK	±256 μK
		4.2 K	1370 Ω	-80.3 Ω/K	902 μK	±8 mK	±24 mK	±1.8 mK
		40 K	1049 Ω	-1.06 Ω/K	62 mK	±500 mK	±537 K	±124 mK
Capacitance	CS-501	4.2	6.0 nF	27 pF/K	74 mK	NA	Calibration not available from Lake Shore	±14.8 mK
		77	9.1 nF	52 pF/K	39 mK			±7.7 mK
		200	19.2 nF	174 pF/K	12 mK			±23 mK
Thermocouple 50 mV 3060	Type K	75 K	-5862.9 μV	15.6 μV/K	26 mK	±0.25 K ⁷	Calibration not available from Lake Shore	±52 mK
		300 K	1075.3 μV	40.6 μV/K	10 mK	±0.038 K ⁷		±20 mK
		600 K	13325 μV	41.7 μV/K	10 mK	±0.184 K ⁷		±20 mK
		1505 K	49998.3 μV	36.006 μV/K	11 mK	±0.73 K ⁷		±22 mK

⁴ Typical sensor sensitivities were taken from representative calibrations for the sensor listed

⁵ Control stability of the electronics only, in an ideal thermal system

⁶ Non-HT version maximum temperature: 325 K

⁷ Accuracy specification does not include errors from room temperature compensation

TABLE 1-2 Typical sensor performance

1.3 Model 336 Specifications

1.3.1 Input Specifications

Standard inputs and scanner option Model 3062	Sensor Temperature Coefficient	Input Range	Excitation Current	Display Resolution	Measurement Resolution	Electronic Accuracy (at 25 °C)	Measurement Temperature Coefficient	Electronic Control Stability ⁸
Diode	Negative	0 V to 2.5 V	10 μ A \pm 0.05% ^{9,10}	100 μ V	10 μ V	\pm 80 μ V \pm 0.005% of rdg	(10 μ V + 0.0005% of rdg)/°C	\pm 20 μ V
	Negative	0 V to 10 V	10 μ A \pm 0.05% ^{9,10}	100 μ V	20 μ V	\pm 320 μ V \pm 0.01% of rdg	(20 μ V + 0.0005% of rdg)/°C	\pm 40 μ V
PTC RTD	Positive	0 Ω to 10 Ω	1 mA ¹¹	0.1 m Ω	0.2 m Ω	\pm 0.002 Ω \pm 0.01% of rdg	(0.01 m Ω + 0.001% of rdg)/°C	\pm 0.4 m Ω
		0 Ω to 30 Ω	1 mA ¹¹	0.1 m Ω	0.2 m Ω	\pm 0.002 Ω \pm 0.01% of rdg	(0.03 m Ω + 0.001% of rdg)/°C	\pm 0.4 m Ω
		0 Ω to 100 Ω	1 mA ¹¹	1 m Ω	2 m Ω	\pm 0.004 Ω \pm 0.01% of rdg	(0.1 m Ω + 0.001% of rdg)/°C	\pm 4 m Ω
		0 Ω to 300 Ω	1 mA ¹¹	1 m Ω	2 m Ω	\pm 0.004 Ω \pm 0.01% of rdg	(0.3 m Ω + 0.001% of rdg)/°C	\pm 4 m Ω
		0 Ω to 1 k Ω	1 mA ¹¹	10 m Ω	20 m Ω	\pm 0.04 Ω \pm 0.02% of rdg	(1 m Ω + 0.001% of rdg)/°C	\pm 40 m Ω
		0 Ω to 3 k Ω	1 mA ¹¹	10 m Ω	20 m Ω	\pm 0.04 Ω \pm 0.02% of rdg	(3 m Ω + 0.001% of rdg)/°C	\pm 40 m Ω
		0 Ω to 10 k Ω	1 mA ¹¹	100 m Ω	200 m Ω	\pm 0.4 Ω \pm 0.02% of rdg	(10 m Ω + 0.001% of rdg)/°C	\pm 400 m Ω
NTC RTD 10 mV	Negative	0 Ω to 10 Ω	1 mA ¹¹	0.1 m Ω	0.2 m Ω	\pm 0.002 Ω \pm 0.06% of rdg	(0.01 m Ω + 0.001% of rdg)/°C	\pm 0.3 m Ω
		0 Ω to 30 Ω	300 μ A ¹¹	0.1 m Ω	0.2 m Ω	\pm 0.002 Ω \pm 0.06% of rdg	(0.03 m Ω + 0.001% of rdg)/°C	\pm 0.9 m Ω
		0 Ω to 100 Ω	100 μ A ¹¹	1 m Ω	1 m Ω	\pm 0.01 Ω \pm 0.04% of rdg	(0.1 m Ω + 0.001% of rdg)/°C	\pm 3 m Ω
		0 Ω to 300 Ω	30 μ A ¹¹	1 m Ω	2 m Ω	\pm 0.01 Ω \pm 0.04% of rdg	(0.3 m Ω + 0.001% of rdg)/°C	\pm 9 m Ω
		0 Ω to 1 k Ω	10 μ A ¹¹	10 m Ω	10 m Ω + 0.002% of rdg	\pm 0.1 Ω \pm 0.04% of rdg	(1 m Ω + 0.001% of rdg)/°C	\pm 30 m Ω \pm 0.004% of rdg
		0 Ω to 3 k Ω	3 μ A ¹¹	10 m Ω	20 m Ω + 0.002% of rdg	\pm 0.1 Ω \pm 0.04% of rdg	(3 m Ω + 0.001% of rdg)/°C	\pm 90 m Ω \pm 0.004% of rdg
		0 Ω to 10 k Ω	1 μ A ¹¹	100 m Ω	100 m Ω + 0.002% of rdg	\pm 1.0 Ω \pm 0.04% of rdg	(10 m Ω + 0.001% of rdg)/°C	\pm 300 m Ω \pm 0.004% of rdg
		0 Ω to 30 k Ω	300 nA ¹¹	100 m Ω	200 m Ω + 0.002% of rdg	\pm 2.0 Ω \pm 0.04% of rdg	(30 m Ω + 0.001% of rdg)/°C	\pm 900 m Ω \pm 0.004% of rdg
		0 Ω to 100 k Ω	100 nA ¹¹	1 Ω	1 Ω + 0.005% of rdg	\pm 10.0 Ω \pm 0.04% of rdg	(100 m Ω + 0.001% of rdg)/°C	\pm 3 Ω \pm 0.01% of rdg

⁸ Control stability of the electronics only, in ideal thermal system

⁹ Current source error has negligible effect on measurement accuracy

¹⁰ Diode input excitation can be set to 1 mA

¹¹ Current source error is removed during calibration

¹² Accuracy specification does not include errors from room temperature compensation

TABLE 1-3 Input specifications

Thermocouple option Model 3060	Sensor Temperature Coefficient	Input Range	Excitation Current	Display Resolution	Measurement Resolution	Electronic Accuracy (at 25 °C)	Measurement Temperature Coefficient	Electronic Control Stability ¹³
Thermocouple 3060	Positive	±50 mV	NA	0.1 µV	0.4µV	±1 µV ±0.05% of rdg ¹²	(0.1 µV + 0.001% of rdg)/°C	±0.8µV

¹³ Control stability of the electronics only, in ideal thermal system

TABLE 1-4 Thermocouple option input specifications

Capacitance option Model 3061	Sensor Temperature Coefficient	Input Range	Excitation Current	Display Resolution	Measurement Resolution	Electronic Accuracy (at 25 °C)	Measurement Temperature Coefficient	Electronic Control Stability ¹⁴
Capacitance 3061	Positive or negative	0.1 nF to 15 nF	3.496 kHz 1 mA square wave	0.1 pF	0.05 pF	±50 pF ±0.1% of rdg	2.5 pF/°C	0.1 pF
		1 nF to 150 nF	3.496 kHz 10 mA square wave	1 pF	0.5 pF	±50 pF ±0.1% of rdg	5 pF/°C	1 pF

¹⁴ Control stability of the electronics only, in ideal thermal system

TABLE 1-5 Capacitance option input specifications

1.3.2 Sensor Input Configuration

	Diode/RTD	Thermocouple
Measurement type	4-lead differential	2-lead differential, room temperature compensated
Excitation	Constant current with current reversal for RTDs	NA
Supported sensors	Diodes: Silicon, GaAlAs RTDs: 100 Ω Platinum (option), 1000 Ω Platinum, Germanium, Carbon-Glass, Cernox™, and Rox™	Most thermocouple types
Standard curves	DT-470, DT-670, DT-500-D, DT-500-E1, PT-100, PT-1000, RX-102A, RX-202A	Type E, Type K, Type T, AuFe 0.07% vs. Cr, AuFe 0.03% vs. CR
Input connector	6-pin DIN	Screw terminals in a ceramic isothermal block

TABLE 1-6 Sensor input configuration

1.3.3 Thermometry

Number of inputs	4 (8 with Model 3062)
Input configuration	Inputs can be configured from the front panel to accept any of the supported input types. Thermocouple and capacitance inputs require an optional input card that can be installed in the field.
Supported option cards	Thermocouple (3060), capacitance (3061), or scanner (3062)
Option slots	1
Isolation	Sensor inputs optically isolated from other circuits but not each other
A/D resolution	24-bit
Input accuracy	Sensor dependent, refer to Input Specifications table
Measurement resolution	Sensor dependent, refer to Input Specifications table
Maximum update rate	10 rdg/s on each input, 5 rdg/s when configured as 100 kΩ NTC RTD with reversal on
Maximum update rate (scanner)	The maximum update rate for a scanned input is 10 rdg/s distributed among the enabled channels. Any channel configured as 100 kΩ RTD with reversal on changes the update rate for the channel to 5 rdg/s
Autorange	Automatically selects appropriate NTC RTD or PTC RTD range
User curves	Room for 39 200-point CalCurves™ or user curves
SoftCal™	Improves accuracy of DT-470 diode to ±0.25 K from 30 K to 375 K; improves accuracy of platinum RTDs to ±0.25 K from 70 K to 325 K; stored as user curves
Math	Maximum and minimum
Filter	Averages 2 to 64 input readings

1.3.4 Control

There are 4 control outputs.

1.3.4.1 Heater Outputs (Outputs 1 and 2)

Control type	Closed loop digital PID with manual heater output or open loop
Update rate	10/s
Tuning	Autotune (one loop at a time), PID, PID zones
Control stability	Sensor dependent, see Input Specifications table
PID control settings	
Proportional (gain)	0 to 1000 with 0.1 setting resolution
Integral (reset)	1 to 1000 (1000/s) with 0.1 setting resolution
Derivative (rate)	1 to 200% with 1% resolution
Manual output	0 to 100% with 0.01% setting resolution
Zone control	10 temperature zones with P, I, D, manual heater out, heater range, control channel, ramp rate
Setpoint rampin	0.1 K/min to 100 K/min

	25 Ω setting	50 Ω setting
Type	Variable DC current source	
D/A resolution	16-bit	
Max power	100 W	50 W
Max current	2 A	1 A
Compliance voltage	50 V	50 V
Heater load for max power	25 Ω	50 Ω
Heater load range	10 Ω to 100 Ω	
Ranges	3 (decade steps in power)	
Heater noise	0.12 μ A RMS (dominated by line frequency and its harmonics)	
Grounding	Output referenced to chassis ground	
Heater connector	Dual banana	
Safety limits	Curve temperature, power up heater off, short circuit protection	

TABLE 1-7 Output 1

	25 Ω setting	50 Ω setting
Type	Variable DC current source	
D/A resolution	16-bit	
Max power	50 W	50 W
Max current	1.41 A	1 A
Compliance voltage	35.4 V	50 V
Heater load for max power	25 Ω	50 Ω
Heater load range	10 Ω to 100 Ω	
Ranges	3 (decade steps in power)	
Heater noise	0.12 μ A RMS (dominated by line frequency and its harmonics)	
Grounding	Output referenced to chassis ground	
Heater connector	Dual banana	
Safety limits	Curve temperature, power up heater off, short circuit protection	

TABLE 1-8 Output 2

1.3.4.2 Unpowered Analog Outputs (Outputs 3 and 4)

Control type	Closed loop PID, PID zones, warm up heater mode, manual output or Monitor Out
Tuning	Autotune (one loop at a time), PID, PID zones
Control stability	Sensor dependedn, see Input Specifications table
PID control settings	
Proportional (gain)	0 to 1000 with 0.1 setting resolution
Integral (reset)	1 to 1000 (1000/s) with 0.1 setting resolution
Derivative (rate)	1 to 200% with 1% resolution
Manual output	0 to 100% with 0.01% setting resolution
Zone control	10 temperature zones with P, I, D, manual heater out, heater range, control channel, ramp rate
Setpoint ramping	0.1 K/min to 100 K/min
Warm up heater mode settings	
Warm up percentage	0 to 100% with 1% resolution
Warm up mode	Continuous control or auto-off
Monitor Out settings	
Scale	User selected
Data source	Temperature or sensor units
Settings	Input, source, top of scale, bottom of scale or manual
Type	Variable DC voltage source
Update rate	10/s
Range	±10 V
Resolution	16-bit, 0.3 mV
Accuracy	±2.5 mV
Noise	0.3 mV RMS
Minimum load resistance	1 k Ω (short-circuit protected)
Connector	Detachable terminal block

1.3.5 Front Panel

Display	8-line by 40-character (240 × 64 pixel) graphic LCD display module with LED backlight
Number of reading displays	1 to 8
Display units	K, °C, V, mV, Ω
Reading source	Temperature, sensor units, max, and min
Display update rate	2 rdg/s
Temperature display resolution	0.0001° from 0° to 99.9999°, 0.001° from 100° to 999.999°, 0.01° above 1000°
Sensor units display resolution	Sensor dependent, to 6 digits
Other displays	Input name, setpoint, heater range, heater output, and PID
Setpoint setting resolution	Same as display resolution (actual resolution is sensor dependent)
Heater output display	Numeric display in percent of full scale for power or current
Heater output resolution	0.01%
Display annunciators	Control input, alarm, tuning
LED annunciators	Remote, Ethernet status, alarm, control outputs
Keypad	27-key silicone elastomer keypad
Front panel features	Front panel curve entry, display contrast control, and keypad lock-out

1.3.6 Interface

IEEE-488.2	
Capabilities	SH1, AH1, T5, L4, SR1, RL1, PPO, DC1, DTO, CO, E1
Reading rate	To 10 rdg/s on each input
Software support	LabVIEW™ driver (contact Lake Shore for availability)
USB	
Function	Emulates a standard RS-232 serial port
Baud Rate	57,600
Connector	B-type USB connector
Reading rate	To 10 rdg/s on each input
Software support	LabVIEW™ driver (contact Lake Shore for availability)
Ethernet	
Function	TCP/IP web interface, curve handler, configuration backup, chart recorder
Connector	RJ-45
Reading rate	To 10 rdg/s on each input
Software support	LabVIEW™ driver (contact Lake Shore for availability)
Alarms	
Number	4, high and low for each input
Data source	Temperature or sensor units
Settings	Source, high setpoint, low setpoint, deadband, latching or non-latching, audible on/off, and visible on/off
Actuators	Display annunciator, beeper, and relays
Relays	
Number	2
Contacts	Normally open (NO), normally closed (NC), and common (C)
Contact rating	30 VDC at 3 A
Operation	Activate relays on high, low, or both alarms for any input, or manual mode
Connector	Detachable terminal block

1.3.7 General

Ambient temperature	15 °C to 35 °C at rated accuracy; 5 °C to 40 °C at reduced accuracy
Power requirement	100, 120, 220, 240, VAC, ±10%, 50 or 60 Hz, 250 VA
Size	435 mm W × 89 mm H × 368 mm D (17 in × 3.5 in × 14.5 in), full rack
Weight	7.6 kg (16.8 lb)
Approval	CE mark

1.4 Safety Summary and Symbols

Observe these general safety precautions during all phases of instrument operation, service, and repair. Failure to comply with these precautions or with specific warnings elsewhere in this manual violates safety standards of design, manufacture, and intended instrument use. Lake Shore Cryotronics, Inc. assumes no liability for Customer failure to comply with these requirements.

The Model 336 protects the operator and surrounding area from electric shock or burn, mechanical hazards, excessive temperature, and spread of fire from the instrument. Environmental conditions outside of the conditions below may pose a hazard to the operator and surrounding area.

- Indoor use
- Altitude to 2000 m
- Temperature for safe operation: 5 °C to 40 °C
- Maximum relative humidity: 80% for temperature up to 31 °C decreasing linearly to 50% at 40 °C
- Power supply voltage fluctuations not to exceed $\pm 10\%$ of the nominal voltage
- Overvoltage category II
- Pollution degree 2

Ground the Instrument

To minimize shock hazard, the instrument is equipped with a 3-conductor AC power cable. Plug the power cable into an approved 3-contact electrical outlet or use a 3-contact adapter with the grounding wire (green) firmly connected to an electrical ground (safety ground) at the power outlet. The power jack and mating plug of the power cable meet Underwriters Laboratories (UL) and International Electrotechnical Commission (IEC) safety standards.

Ventilation

The instrument has ventilation holes in its side covers. Do not block these holes when the instrument is operating.

Do Not Operate in an Explosive Atmosphere

Do not operate the instrument in the presence of flammable gases or fumes. Operation of any electrical instrument in such an environment constitutes a definite safety hazard.

Keep Away from Live Circuits

Operating personnel must not remove instrument covers. Refer component replacement and internal adjustments to qualified maintenance personnel. Do not replace components with power cable connected. To avoid injuries, always disconnect power and discharge circuits before touching them.

Do Not Substitute Parts or Modify Instrument

Do not install substitute parts or perform any unauthorized modification to the instrument. Return the instrument to an authorized Lake Shore Cryotronics, Inc. representative for service and repair to ensure that safety features are maintained.

Cleaning

Do not submerge instrument. Clean only with a damp cloth and mild detergent. Exterior only.













	Direct current (power line)		Equipment protected throughout by double insulation or reinforces insulation (equivalent to Class II of IEC 536—see Annex H)
	Alternating current (power line)		CAUTION: High voltages; danger of electric shock; background color: yellow; symbol and outline: black
	Alternating or direct current (power line)		CAUTION or WARNING: See instrument documentation; background color: yellow; symbol and outline: black
	Three-phase alternating current (power line)		
	Earth (ground) terminal		
	Protective conductor terminal		
	Frame or chassis terminal		
	On (supply)		
	Off (supply)		

FIGURE 1-4 Safety symbols

Chapter 2: Cooling System Design and Temperature Control

2.1 General

Selecting the proper cryostat or cooling source is probably the most important decision in designing a temperature control system. The cooling source defines minimum temperature, cool-down time, and cooling power. Information on choosing a cooling source is beyond the scope of this manual. This chapter provides information on how to get the best temperature measurement and control from cooling sources with proper setup including sensor and heater installation.

2.2 Temperature Sensor Selection

This section attempts to answer some of the basic questions concerning temperature sensor selection. Additional useful information on temperature sensor selection is available in the Lake Shore Temperature Measurement and Control Catalog. The catalog has a large reference section that includes sensor characteristics and sensor selection criteria.

2.2.1 Temperature Range

You must consider several important sensor parameters when choosing a sensor. The first is experimental temperature range. Some sensors can be damaged by temperatures that are either too high or too low. Manufacturer recommendations should always be followed.

Sensor sensitivity changes with temperature and can limit the useful range of a sensor. It is important not to specify a range larger than necessary. If you perform an experiment at liquid helium temperature, a very high sensitivity is needed for good measurement resolution at that temperature. That same resolution may not be required to monitor warm up to room temperature. Two different sensors may be required to tightly cover the range from base temperature to room temperature, but lowering the resolution requirement on warm up may allow a less expensive, 1 sensor solution.

Another thing to consider when choosing a temperature sensor is that instruments like the Model 336 are not able to read some sensors over their entire temperature range. Lake Shore sells calibrated sensors that operate down to 20 millikelvin (mK), but the Model 336 is limited to above 300 mK in its standard configuration.

2.2.2 Sensor Sensitivity

Temperature sensor sensitivity is a measure of how much a sensor signal changes when the temperature changes. It is an important sensor characteristic because so many measurement parameters are related to it. Resolution, accuracy, noise floor, and even control stability depend on sensitivity. Many sensors have different sensitivities at different temperatures. For example, a platinum sensor has good sensitivity at higher temperatures, but it has limited use below 30 K because its sensitivity drops sharply. It is difficult to determine if a sensor has adequate sensitivity over the experimental temperature range. This manual has specifications (section 1.3) that include sensor sensitivity translated into temperature resolution and accuracy at different points. This is typical sensor response and can be used as a guide when choosing a sensor to be used with the Model 336.

2.2.3 Environmental Conditions

The experimental environment is also important when choosing a sensor. Environmental factors such as high vacuum, magnetic field, corrosive chemicals, or even radiation can limit the use of some types of sensors. Lake Shore has devoted much time to developing sensor packages that withstand the temperatures, vacuum levels, and bonding materials found in typical cryogenic cooling systems.

Experiments done in magnetic fields are very common. Field dependence of temperature sensors is an important selection criteria for sensors used in these experiments. This manual briefly qualifies the field dependence of most common sensors in the specifications (section 1.3). Detailed field dependence tables are included in the Lake Shore Temperature Measurement and Control Catalog. When available, specific data on other environmental factors is also included in the catalog.

2.2.4 Measurement Accuracy

Temperature measurements have several sources of uncertainty that reduce accuracy. Be sure to account for errors induced by both the sensor and the instrumentation when computing accuracy. The instrument has measurement error in reading the sensor signal, and error in calculating a temperature using a temperature response curve. Error results when the sensor is compared to a calibration standard and the temperature response of a sensor will shift with time and with repeated thermal cycling (from very cold temperatures to room temperature). Instrument and sensor manufacturers specify these errors, but there are things you can do to maintain good accuracy. For example, choose a sensor that has good sensitivity in the most critical temperature range, as sensitivity can minimize the effect of most error sources. Install the sensor properly following guidelines in section 2.4. Calibrate the sensor and instrument periodically, or in some other way null the time dependent errors. Use a sensor calibration that is appropriate for the accuracy requirement.

2.2.5 Sensor Package

There are different packages for the various types of sensors. Some types of sensors can even be purchased as bare chips without any package. A sensor package generally determines its size, thermal and electrical contact to the outside, and sometimes limits temperature range. When different packages are available for a sensor, you should consider the mounting surface for the sensor and how the leads will be thermally anchored when choosing.

2.3 Sensor Calibrations

It can sometimes be confusing to choose the right sensor, get it calibrated, translate the calibration data into a temperature response curve that the Model 336 can understand, and then load the curve into the instrument. Lake Shore provides a variety of calibration services to fit different accuracy requirements and budgets.

Best	Precision calibration	All sensors can be calibrated over various temperature ranges. Lake Shore has defined calibration ranges available for each sensor type.
Better	SoftCal™	An abbreviated calibration (2-point: 77 K and 305 K; 3-point: 4.2 K, 77 K, and 305 K; or 3-point: 77 K, 305 K, and 480 K), which is available for 400 Series silicon diodes and platinum sensors
Good	Sensors using standard curves	Silicon diodes follow standard curves
		Platinum resistors follow standard curves
		Ruthenium oxide (Rox™) resistors follow standard curves
		Thermocouples follow standard curves
		GaAlAs diode, carbon-glass, Cernox™, germanium, and rhodium-iron sensors can be purchased uncalibrated, but must be calibrated to accurately read in temperature units

TABLE 2-1 *Sensor diode sensor calibrations*

2.3.1 Precision Calibration

To calibrate, Lake Shore compares a sensor with an unknown temperature response to an accepted standard. Lake Shore temperature standards are traceable to the U.S. National Institute of Standards and Testing (NIST) or the National Physical Laboratory in Great Britain. These standards allow Lake Shore to calibrate sensors from 20 mK to above room temperature. Calibrated sensors are more expensive than uncalibrated sensors of the same type because of the labor, cryogen use, and capitol equipment used in the process.

Precision calibration provides the most accurate temperature sensors available from Lake Shore. Uncertainty from sensor calibration is almost always smaller than the error contributed by the Model 336. The Lake Shore Temperature Measurement and Control Catalog has complete accuracy specifications for calibrated sensors.

Calibrated sensors include the measured test data printed and plotted, the coefficients of a Chebychev polynomial that have been fitted to the data, and two tables of data points to be used as interpolation tables. Both interpolation tables are optimized to allow accurate temperature conversion. The smaller table, called a break-point interpolation table, is sized to fit into instruments like the Model 336 where it is called a temperature response curve.

It is important to look at instrument specifications before ordering calibrated sensors. A calibrated sensor is required when a sensor does not follow a standard curve if you wish to display in temperature. Otherwise the Model 336 will operate in sensor units like ohms or volts. The Model 336 may not work over the full temperature range of some sensors. The standard inputs in are limited to operation above 300 mK even with sensors that can be calibrated to 20 mK.

2.3.2 SoftCal™

SoftCal™ is a good solution for applications that do not require the accuracy of a precision calibration. The SoftCal™ algorithm uses the well-behaved nature of sensors that follow a standard curve to improve the accuracy of individual sensors. A few known temperature points are required to perform SoftCal™. The Model 336 can also perform a SoftCal™ calibration. You need to provide one, two, or three known temperature reference points. The range and accuracy of the calibration is based on these points (section 5.10).

Lake Shore offers two or three point SoftCal™ calibrated sensors that include both the large interpolation table and the smaller breakpoint interpolation table for 400 series diode and Platinum sensors.

2.3.3 Sensors Using Standard Curves

Some types of sensors behave in a very predictable manner and a standard temperature response curve can be created for them. Standard curves are a convenient and inexpensive way to get reasonable temperature accuracy. Sensors that have a standard curve are often used when interchangeability is important. Some individual sensors are selected for their ability to match a published standard curve, but in general these sensors do not provide the accuracy of a calibrated sensor. For convenience, the Model 336 has several standard curves included in firmware.

2.3.4 Curve Handler™

Lake Shore provides a software application, called Curve Handler™, which makes loading temperature curves into the Model 336 a very simple process. The program can copy curves from properly formatted files into the Model 336 user curve locations. You can also use it to read curves from the Model 336 and save them to files. Lake Shore calibrated sensors are provided with a CD containing all the proper formats to load curves using the Curve Handler™ software program.

There are two versions of the Curve Handler™ application. The fully featured version is a 32-bit Microsoft Windows™ application that must be installed on a Windows™ PC. This version works with the IEEE-488 and USB computer interfaces on the Model 336, and allows you to manipulate the temperature curves directly in the program window. This version will also work with all existing Lake Shore temperature controller and temperature monitor instruments. The Windows™ version of the Curve Handler™ application is available, free of charge, from the Lake Shore website at www.lakeshore.com.

The second version of Curve Handler™ is written in the Java™ programming language and is available through the Ethernet web interface on the Model 336. This version allows you to copy curves from files to the Model 336, and vice versa, but it does not allow manipulation of curve data and only works using the Ethernet interface. Refer to section 6.4.4 for details on connecting to the web interface and opening the embedded Curve Handler™ application.

2.4 Sensor Installation

This section highlights some of the important elements of proper sensor installation. For more detailed information, Lake Shore sensors are shipped with installation instructions that cover that specific sensor type and package. The Lake Shore Temperature Measurement and Control Catalog includes an installation section as well. To further help you properly install sensors, Lake Shore offers a line of cryogenic accessories. Many of the materials discussed are available through Lake Shore and can be ordered with sensors or instruments.

2.4.1 Mounting Materials

Choosing appropriate mounting materials is very important in a cryogenic environment. The high vacuum used to insulate cryostats is one consideration. Materials used in these applications should have a low vapor pressure so they do not evaporate or out-gas and spoil the vacuum insulation. Metals and ceramics do not have this problem, but greases and varnishes must be checked. Another consideration is the wide extremes in temperature most sensors are exposed to. The linear expansion coefficient of materials becomes important when temperature changes are large. Never try to permanently bond materials with linear expansion coefficients that differ by more than three. Use a flexible mounting scheme or the parts will break apart, potentially damaging them. The thermal expansion or contraction of rigid clamps or holders could crush fragile samples or sensors that do not have the same coefficient. Thermal conductivity is a property of materials that can change with temperature. Do not assume that a thermal anchor grease that works well at room temperature and above will do the same job at low temperatures.

2.4.2 Sensor Location

Finding a good place to mount a sensor in an already crowded cryostat is never easy. There are fewer problems if the entire load and sample holder are at the same temperature. Unfortunately, this is not the case in many systems. Temperature gradients (differences in temperature) exist because there is seldom perfect balance between the cooling source and heat sources. Even in a well-controlled system, unwanted heat sources like thermal radiation and heat conducting through mounting structures can cause gradients. For best accuracy, position sensors near the sample, so that little or no heat flows between the sample and sensor. This may not, however, be the best location for temperature control as discussed below.

2.4.3 Thermal Conductivity

The ability of heat to flow through a material is called thermal conductivity. Good thermal conductivity is important in any part of a cryogenic system that is intended to be the same temperature. Copper and aluminum are examples of metals that have good thermal conductivity, while stainless steel does not. Non-metallic, electrically-insulating materials like alumina oxide and similar ceramics have good thermal con-

ductivity, while G-10 epoxy-impregnated fiberglass does not. Sensor packages, cooling loads, and sample holders should have good thermal conductivity to reduce temperature gradients. Surprisingly, the connections between thermally conductive mounting surfaces often have very poor thermal conductivity (refer to section 2.4.4 and section 2.4.5).

2.4.4 Contact Area

Thermal contact area greatly affects thermal conduction because a larger area has more opportunity to transfer heat. Even when the size of a sensor package is fixed, thermal contact area can be improved with the use of a gasket material like indium foil and cryogenic grease. A soft gasket material forms into the rough mating surface to increase the area of the two surfaces that are in contact. Good gasket materials are soft, thin, and have good thermal conductivity. They must also withstand the environmental extremes. Indium foil and cryogenic grease are good examples.

2.4.5 Contact Pressure

When sensors are permanently mounted, the solder or epoxy used to hold the sensor act as both gasket and adhesive. Permanent mounting is not a good solution for everyone because it limits flexibility and can potentially damage sensors. Much care should be taken not to over heat or mechanically stress sensor packages. Less permanent mountings require some pressure to hold the sensor to its mounting surface. Pressure greatly improves the action of gasket material to increase thermal conductivity and reduce thermal gradients. A spring clamp is recommended so that different rates of thermal expansion do not increase or decrease pressure with temperature change.

2.4.6 Lead Wire

Different types of sensors come with different types and lengths of electrical leads. In general a significant length of lead wire must be added to the sensor for proper thermal anchoring and connecting to a bulk head connector at the vacuum boundary. The lead wire must be a good electrical conductor, but should not be a good thermal conductor, or heat will transfer down the leads and change the temperature reading of the sensor. Small 30 AWG to 40 AWG wire made of an alloy like phosphor bronze is much better than copper wire. Thin wire insulation is preferred, and twisted wire should be used to reduce the effect of RF noise if it is present. The wire used on the room temperature side of the vacuum boundary is not critical, so copper cable is normally used.

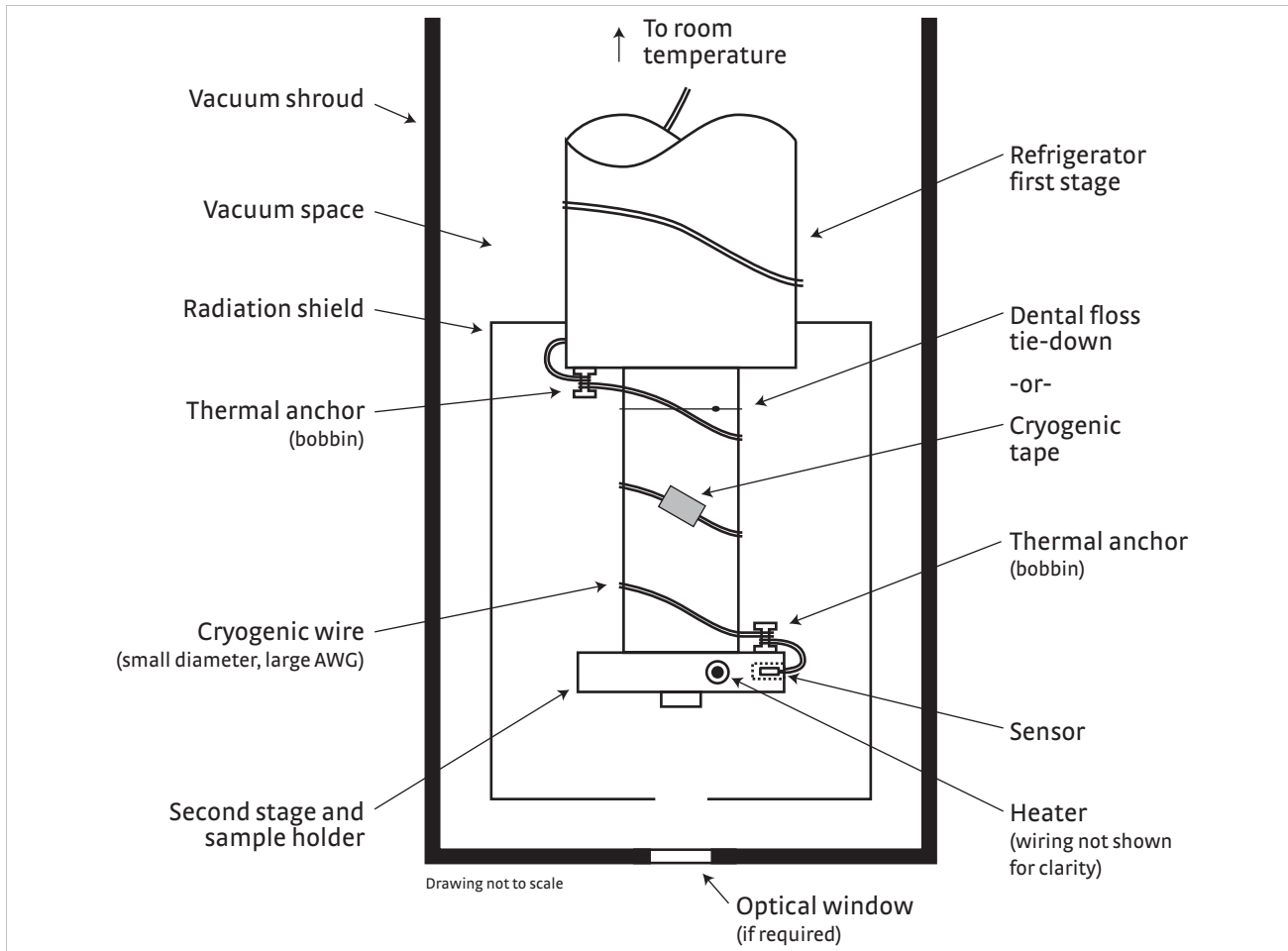

FIGURE 2-1 Typical sensor installation in a mechanical refrigerator

2.4.7 Lead Soldering

When you solder additional wire to short sensor leads, be careful not to overheat the sensor. A thermal anchor such as a metal wire clamp or alligator clip will anchor the leads and protect the sensor. Leads should be tinned before bonding to reduce the time that heat is applied to the sensor lead. Clean the solder flux after soldering to prevent corrosion or outgassing in vacuum.

2.4.8 Thermal Anchoring Leads

Sensor leads can be a significant source of error if they are not properly anchored. Heat will transfer down even small leads and alter the sensor reading. The goal of thermal anchoring is to cool the leads to a temperature as close to the sensor as possible. This can be accomplished by putting a significant length of lead wire in thermal contact with every cooled surface between room temperature and the sensor. You can adhere lead wires to cold surfaces with varnish over a thin electrical insulator like cigarette paper. They can also be wound onto a bobbin that is firmly attached to the cold surface. Some sensor packages include a thermal anchor bobbin and wrapped lead wires to simplify thermal anchoring.

2.4.9 Thermal Radiation

Thermal (black body) radiation is one of the ways heat is transferred. Warm surfaces radiate heat to cold surfaces even through a vacuum. The difference in temperature between the surfaces is one thing that determines how much heat is transferred. Thermal radiation causes thermal gradients and reduces measurement accuracy. Many cooling systems include a radiation shield. The purpose of the shield is to surround the sample stage, sample, and sensor with a surface that is at or near their temperature to minimize radiation. The shield is exposed to the room temperature

surface of the vacuum shroud on its outer surface, so some cooling power must be directed to the shield to keep it near the load temperature. If the cooling system does not include an integrated radiation shield (or one cannot be easily made), one alternative is to wrap several layers of super-insulation (aluminized mylar) loosely between the vacuum shroud and load. This reduces radiation transfer to the sample space.

2.5 Heater Selection and Installation

2.5.1 Heater Resistance and Power

There is a variety of resistive heaters that can be used as the controlled heating source for temperature control. The mostly metal alloys like nichrome are usually wire or foil. Shapes and sizes vary to permit installation into different systems.

Cryogenic cooling systems have a wide range of cooling power. The resistive heater must be able to provide sufficient heating power to warm the system. The Model 336 can provide up to 100 W of power from Output 1 and up to 50 W of power from Output 2. TABLE 2-2 provides the current and voltage limits, as well as the resulting maximum power for each output for the 25 Ω and 50 Ω settings, using nominal heater load values.

		25Ω setting (25 Ω heater)	50 Ω setting (50 Ω heater)
Output 1	Current limit	2 A	1 A
	Voltage limit	50 V	50 V
	Max power	100 W	50 W
Output 2	Current limit	1.41 A	1 A
	Voltage limit	50 V	50 V
	Max power	50 W	50 W

TABLE 2-2 Current and voltage limits with resulting max power

Even though the Model 336 heater outputs are current sources, they have a limit of 50 V (called the compliance voltage). This compliance voltage also limits maximum power. So for heaters values other than 25 Ω or 50 Ω, calculate the maximum power using the following equations: $P = I^2R$ and $P = V^2/R$, where P is maximum power, I is max current, V is max voltage, and R is the heater resistance. The current and voltage limits are in place at the same time, so the smaller of the two computations gives the maximum power available to the heater.

Example 1: A 20 Ω heater is connected to Output 1, and the heater resistance setting is set to 25 Ω, which can provide up to 2 A of current, and up to 50 V.

Current Limit	Voltage Limit:
$P = I^2R$	$P = V^2/R$
$P = (2 A)^2 \times (20 \Omega)$	$P = (50 V)^2 / (20 \Omega)$
$P = 80 W$	$P = 125 W$

The power limit is the smaller of the two, or 80 W, limited by current.

Example 2: A 60 Ω heater is connected to Output 2, and the heater resistance setting is set to 50 Ω, which can provide up to 1 A of current, and up to 50 V.

Current Limit	Voltage Limit:
$P = I^2R$	$P = V^2/R$
$P = (1 A)^2 \times (60 \Omega)$	$P = (50 V)^2 / (60 \Omega)$
$P = 60 W$	$P = 41.7 W$

The power limit is the smaller of the two, or 41.7 W, limited by voltage.



It is possible to choose a heater value that results in a maximum power greater than the power rating of 50 W for output 2, but doing so can cause the Model 336 to work improperly. In this situation the max user current setting should be used to limit the power. Refer to section 4.5.1.1.1 for details on using the max user current setting.

The resistor chosen as a heater must be able to withstand the power being dissipated in it. Pre-packaged resistors have a power specification that is usually given for the resistor in free air. This power may need to be derated if used in a vacuum where convection cooling cannot take place and it is not adequately anchored to a cooled surface. The Model 336 has a current limit feature which allows you to specify the maximum output current for each heater output (section 4.5.1.1), which when set appropriately will help protect the heater from being over heated.

2.5.2 Heater Location

For best temperature measurement accuracy, position the heater so that temperature gradients across the sample is minimized. For best control the heater should be in close thermal contact with the cooling power. Geometry of the load can make one or both of these difficult to achieve. That is why there are several heater shapes and sizes.

2.5.3 Heater Types

Resistive wire like nichrome is the most flexible type of heater available. The wire can be purchased with electrical insulation and has a predictable resistance per given length. This type of heater wire can be wrapped around a load to give balanced, even heating of the area. Similar to sensor lead wire, the entire length of the heater wire should be in good thermal contact with the load to allow for thermal transfer. Thermal anchoring also protects the wire from over heating and burning out.

Resistive heater wire is also wound into cartridge heaters. Cartridge heaters are more convenient, but are bulky and more difficult to place on small loads. A typical cartridge is 6.35 mm (0.25 in) in diameter and 25.4 mm (1 in) long. The cartridge should be snugly held in a hole in the load or clamped to a flat surface. Thermal anchoring for good thermal contact is again important.

Foil heaters are thin layers of resistive material adhered to, or screened onto, electrically insulating sheets. There are a variety of shapes and sizes. The proper size heater can evenly heat a flat surface or around a round load. The entire active area should be in good thermal contact with the load, not only for maximum heating effect, but to keep spots in the heater from over heating and burning out.

2.5.4 Heater Wiring

When wiring inside a vacuum shroud, we recommend using 30 AWG copper wire for heater leads. Too much heat can transfer in when larger wire is used. Thermal anchoring, similar to that used for the sensor leads, should be included so that any heat transfer does not warm the load when the heater is not running. The lead wires should be twisted to minimize noise coupling between the heater and other leads in the system. When wiring outside the vacuum shroud, you can use larger gage copper, and twisting is still recommended.

2.6 Consideration for Good Control

Most of the techniques discussed in section 2.4 and section 2.5 to improve cryogenic temperature accuracy apply to control as well. There is an obvious exception in sensor location. A compromise is suggested below in section 2.6.3.

2.6.1 Thermal Conductivity

Good thermal conductivity is important in any part of a cryogenic system that is intended to be at the same temperature. Most systems begin with materials that have good conductivity themselves, but as sensors, heaters, sample holders, etc., are added to an ever more crowded space, the junctions between parts are often overlooked. In order for control to work well, junctions between the elements of the control loop must be in close thermal contact and have good thermal conductivity. Gasket materials should always be used along with reasonable pressure (section 2.4.4 and section 2.4.5).

2.6.2 Thermal Lag

Poor thermal conductivity causes thermal gradients that reduce accuracy and also cause thermal lag that make it difficult for controllers to do their job. Thermal lag is the time it takes for a change in heating or cooling power to propagate through the load and get to the feedback sensor. Because the feedback sensor is the only thing that lets the controller know what is happening in the system, slow information to the sensor slows the response time. For example, if the temperature at the load drops slightly below the setpoint, the controller gradually increases heating power. If the feedback information is slow, the controller puts too much heat into the system before it is told to reduce heat. The excess heat causes a temperature overshoot, which degrades control stability. The best way to improve thermal lag is to pay close attention to thermal conductivity both in the parts used and their junctions.

2.6.3 Two-Sensor Approach

There is a conflict between the best sensor location for measurement accuracy and the best sensor location for control. For measurement accuracy the sensor should be very near the sample being measured, which is away from the heating and cooling sources to reduce heat flow across the sample and thermal gradients. The best control stability is achieved when the feedback sensor is near both the heater and cooling source to reduce thermal lag. If both control stability and measurement accuracy are critical it may be necessary to use two sensors, one for each function. Many temperature controllers including the Model 336 have multiple sensor inputs for this reason.

2.6.4 Thermal Mass

Cryogenic designers understandably want to keep the thermal mass of the load as small as possible so the system can cool quickly and improve cycle time. Small mass can also have the advantage of reduced thermal gradients. Controlling a very small mass is difficult because there is no buffer to adsorb small changes in the system. Without buffering, small disturbances can very quickly create large temperature changes. In some systems it is necessary to add a small amount of thermal mass such as a copper block in order to improve control stability.

2.6.5 System Non-Linearity

Because of nonlinearities, a system controlling well at one temperature may not control well at another temperature. While nonlinearities exist in all temperature control systems, they are most evident at cryogenic temperatures. When the operating temperature changes the behavior of the control loop, the controller must be retuned. As an example, a thermal mass acts differently at different temperatures. The specific heat of the load material is a major factor in thermal mass. The specific heat of materials like copper change as much as three orders of magnitude when cooled from 100 K to 10 K. Changes in cooling power and sensor sensitivity are also sources of nonlinearity.

The cooling power of most cooling sources also changes with load temperature. This is very important when operating at temperatures near the highest or lowest temperature that a system can reach. Nonlinearities within a few degrees of these high and low temperatures make it very difficult to configure them for stable control. If difficulty is encountered, it is recommended to gain experience with the system at temperatures several degrees away from the limit and gradually approach it in small steps.

Keep an eye on temperature sensitivity. Sensitivity not only affects control stability, but it also contributes to the overall control system gain. The large changes in sensitivity that make some sensors so useful may make it necessary to retune the control loop more often.

2.7 PID Control

For closed-loop operation, the Model 336 temperature controller uses an algorithm called PID control. The control equation for the PID algorithm has three variable terms: proportional (P), integral (I), and derivative (D). See FIGURE 2-2. Changing these variables for best control of a system is called tuning. The PID equation in the Model 336 is:

$$\text{Heater Output} = P \left[e + I \int (e) dt + D \frac{de}{dt} \right]$$

where the error (e) is defined as: $e = \text{Setpoint} - \text{Feedback Reading}$.

Proportional is discussed in section 2.7.1. Integral is discussed in section 2.7.2. Derivative is discussed in section 2.7.3. Finally, the manual heater output is discussed in section 2.7.4.

2.7.1 Proportional (P)

The Proportional term, also called gain, must have a value greater than 0 for the control loop to operate. The value of the proportional term is multiplied by the error (e) which is defined as the difference between the setpoint and feedback temperatures, to generate the proportional contribution to the output: $\text{Output (P)} = Pe$. If proportional is acting alone, with no integral, there must always be an error or the output will go to 0. A great deal must be known about the load, sensor, and controller to compute a proportional setting (P). Most often, the proportional setting is determined by trial and error. The proportional setting is part of the overall control loop gain, and so are the heater range and cooling power. The proportional setting will need to change if either of these change.

2.7.2 Integral (I)

In the control loop, the integral term, also called reset, looks at error over time to build the integral contribution to the output:

$$\text{Output (I)} = PI \int (e) dt$$

By adding the integral to proportional contributions, the error that is necessary in a proportional only system can be eliminated. When the error is at 0, controlling at the setpoint, the output is held constant by the integral contribution. The integral setting (I) is more predictable than the gain setting. It is related to the dominant time constant of the load. As discussed in section 2.8.3, measuring this time constant allows a reasonable calculation of the integral setting. In the Model 336, the integral term is not set in seconds like some other systems. The integral setting can be derived by dividing 1000 by the integral seconds: $I_{\text{setting}} = 1000 / I_{\text{seconds}}$.

2.7.3 Derivative (D)

The derivative term, also called rate, acts on the change in error with time to make its contribution to the output:

$$\text{Output (D)} = PD \frac{de}{dt}$$

By reacting to a fast changing error signal the derivative can work to boost the output when the setpoint changes quickly, reducing the time it takes for temperature to reach the setpoint. It can also see the error decreasing rapidly when the temperature nears the setpoint and reduce the output for less overshoot. The derivative term can be useful in fast changing systems, but it is often turned off during steady state control because it reacts too strongly to small disturbances. The derivative setting (D) is related to the dominant time constant of the load similar to the I-setting and is therefore set relative to I-setting when used.

2.7.4 Manual Output

The Model 336 has a control setting that is not a normal part of a PID control loop. Manual Output can be used for open loop control, meaning feedback is ignored and the heater output stays at the user's manual setting. This is a good way to put constant heating power into a load when needed. The Manual Output term can also be added to the PID output. Some users prefer to set a power near that necessary to control at a setpoint and let the closed loop make up the small difference. Manual Output is set in percent of full scale current or power for a given heater range (section 4.5.1.5.5).



Manual Output should be set to 0% when not in use.

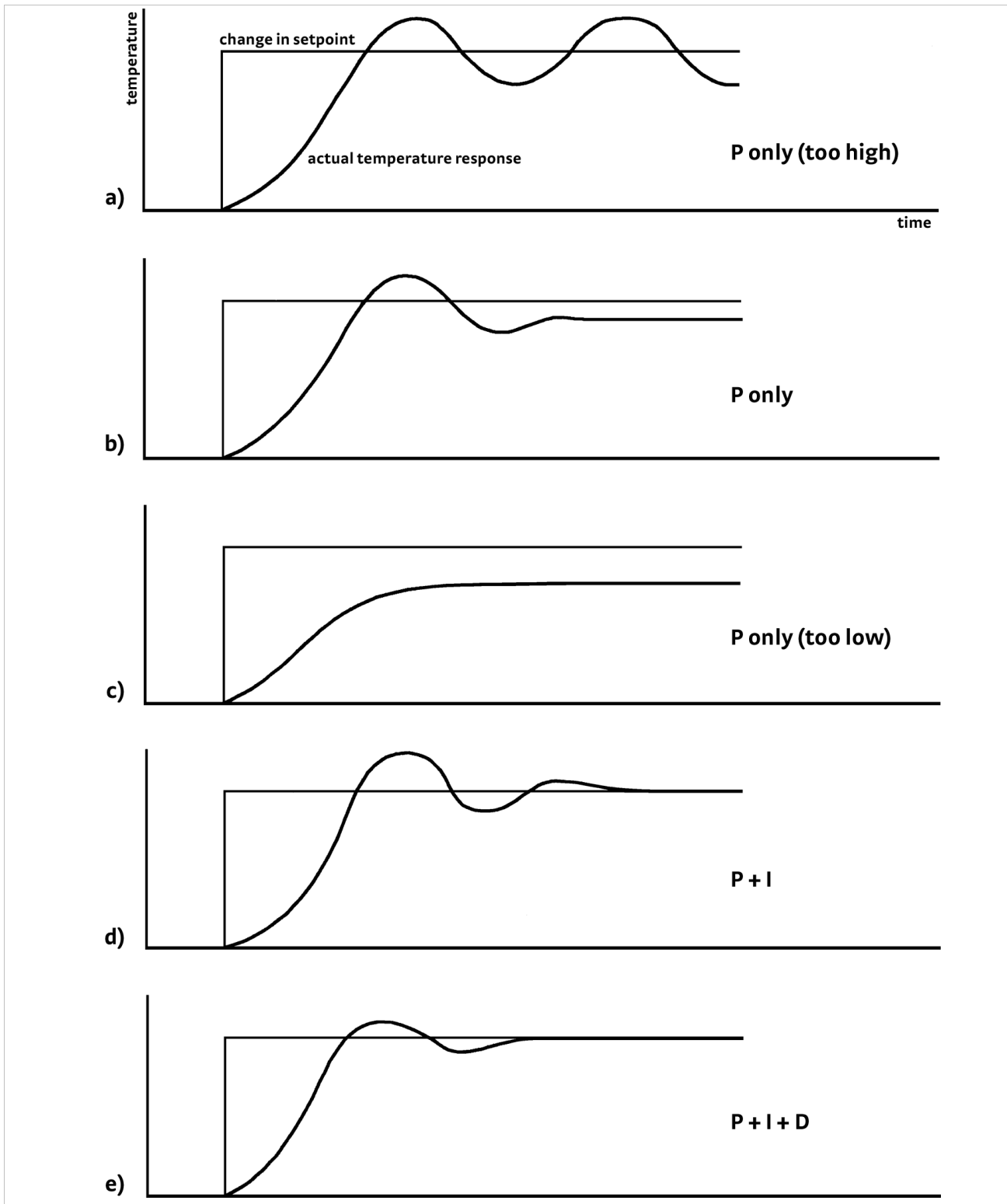

FIGURE 2-2 Examples of PID control

2.8 Manual Tuning

There has been a lot written about tuning closed loop control systems and specifically PID control loops. This section does not attempt to compete with control theory experts. It describes a few basic rules of thumb to help less experienced users get started. This technique will not solve every problem, but it has worked for many others in the field. This section assumes you have worked through the operation sections of this manual, have a good temperature reading from the sensor chosen as a control sensor, and are operating Loop 1. It is also a good idea to begin at the center of the temperature range of the cooling system (not close to its highest or lowest temperature). Autotune (section 2.9) is another good place to begin, and do not forget the power of trial and error.

2.8.1 Setting Heater Range

Setting an appropriate heater output range is an important first part of the tuning process. The heater range should allow enough heater power to comfortably overcome the cooling power of the cooling system. If the heater range will not provide enough power, the load will not be able to reach the setpoint temperature. Conversely, if the range is set too high, the load may have very large temperature changes that take a long time to settle out. Delicate loads can even be damaged by too much power.

Often there is little information on the cooling power of the cooling system at the desired setpoint. If this is the case, try the following: allow the load to cool completely with the heater off. Set Manual Output to 50% while in Open Loop control mode. Turn the heater to the lowest range and write down the temperature rise (if any). Select the next highest heater range and continue the process until the load warms up to room temperature. Do not leave the system unattended; the heater may have to be turned off manually to prevent overheating. If the load never reaches room temperature, some adjustment may be needed in heater resistance or load.

The list of heater range versus load temperature is a good reference for selecting the proper heater range. It is common for systems to require two or more heater ranges for good control over their full temperature. Lower heater ranges are normally needed for lower temperature. The Model 336 is of no use controlling at or below the temperature reached when the heater was off. Many systems can be tuned to control within a degree or two above that temperature.

2.8.2 Tuning Proportional

The proportional setting is so closely tied to heater range that they can be thought of as fine and course adjustments of the same setting. An appropriate heater range must be known before moving on to the proportional setting.

1. Allow the cooling system to cool and stabilize with the heater off.
2. Place the Model 336 in closed loop PID mode tuning,
3. Turn integral, derivative and manual output settings to 0.
4. Enter a setpoint several degrees above the cooling system's lowest temperature.
5. Enter a low proportional setting of approximately 5 or 10, and enter the appropriate heater range as described in section 2.8.1.
6. The load temperature should stabilize at a temperature below the setpoint. The heater display should show a value greater than 0% and less than 100%. If the load temperature does not stabilize below the setpoint, do one of the following:
 - a. If the load temperature and heater display reading swing rapidly, the proportional setting or possibly the heater range may be set too high. Reduce the proportional setting or the heater range, and go back to step 6.
 - b. If the load temperature and heater display reading change very slowly, a condition described as drift, it is an indication of a proportional setting that is too low. Increase the proportional setting and go back to step 6.

7. Gradually increase the proportional setting by doubling it each time. At each new setting, allow time for the temperature of the load to stabilize.
8. Repeat step 7 until you reach a setting in which the load temperature begins a sustained and predictable oscillation, rising and falling in a consistent period of time. See FIGURE 2-2(a).



The goal is to find the proportional value in which the oscillation begins, do not turn the setting so high that temperature and heater output changes become extreme.

9. If step 8 is achieved, complete steps 10 and 11, if not skip to step 12.
10. Record the proportional setting and the amount of time it takes for the load to change from one temperature peak to the next. The time is called the oscillation period of the load. It helps describe the dominant time constant of the load, which is used in setting integral.
11. Reduce the proportional setting by half. The appropriate proportional setting is one half of the value required for sustained oscillation in step 8. See FIGURE 2-2(b). Continue to Tuning Integral section 2.8.3.
12. There are a few systems that will stabilize and not oscillate with a very high proportional setting and a proper heater range setting. For these systems, setting a proportional setting of one half of the highest setting is a good starting point. Continue to the Tuning Integral section 2.8.3.

2.8.3 Tuning Integral

When the proportional setting is chosen and the integral is set to 0 (off), the Model 336 controls the load temperature below the setpoint. Setting the integral allows the Model 336 control algorithm to gradually eliminate the difference in temperature by integrating the error over time. See FIGURE 2-2(d). An integral setting that is too low causes the load to take too long to reach the setpoint. An integral setting that is too high creates instability and can cause the load temperature to oscillate.

1. Begin this part of the tuning process with the system controlling in proportional only mode.
2. Use the oscillation period of the load that was measured in section 2.8.2 in seconds. Divide 1000 by the oscillation period to get the integral setting.
3. Enter the integral setting into the Model 336 and watch the load temperature approach the setpoint.
4. Adjust the integral setting if necessary:
 - a. If the temperature does not stabilize and begins to oscillate around the setpoint, the integral setting is too high and should be reduced by one half.
 - b. If the temperature is stable but never reaches the setpoint, the integral setting is too low and should be doubled.
5. Verify the integral setting by making a few small (2 K to 5 K) changes in setpoint, and watch the load temperature react.

Trial and error can help improve the integral setting by optimizing for experimental needs. Faster integrals, for example, get to the setpoint more quickly at the expense of greater overshoot. In most systems, setpoint changes that raise the temperature act differently than changes that lower the temperature.

If it was not possible to measure the oscillation period of the load during proportional setting, start with an integral setting of 20. If the load becomes unstable, reduce the setting by half. If the load is stable, make a series of small, two to five degree changes in the setpoint and watch the load react. Continue to increase the integral setting until the desired response is achieved.

2.8.4 Tuning Derivative

If an experiment requires frequent changes in setpoint, derivative should be considered. See FIGURE 2-2(e). A derivative setting of 0, off, is recommended when the control system is seldom changed and data is taken when the load is at steady state.

The derivative setting is entered into the Model 336 as a percentage of the integral time constant. The setting range is 0–200% where 100% = $\frac{1}{4}$ I seconds. Start with a setting of 50% to 100%.

Again, do not be afraid to make some small setpoint changes; halving or doubling this setting to watch the affect. Expect positive setpoint changes to react differently from negative setpoint changes.

2.9 Autotuning

Choosing appropriate PID control settings can be tedious. Systems can take several minutes to complete a setpoint change, making it difficult to watch the display for oscillation periods and signs of instability. With the Autotune feature, the Model 336 automates the tuning process by measuring system characteristics and, along with some assumptions about typical cryogenic systems, computes setting values for P, I, and D. Autotune works only with one control loop at a time and does not set the manual output or heater range. Setting an inappropriate heater range is potentially dangerous to some loads, so the Model 336 does not automate that step of the tuning process.

When Autotune is initiated, step changes are applied to the setpoint and the system response is observed to determine the best tuning parameters.

The Autotuning message appears when autotuning, and the display is configured to show the output of the control loop being tuned. The message blinks to indicate that the algorithm is still processing, and displays the current stage of the process, such as Stage 3 of 7. If the tuning process completes successfully, then the message is removed and the new PID parameters are configured. If the algorithm fails, the message stops blinking to indicate that it is no longer processing, and a failure message appears to indicate which stage of the process failed.

There are situations where Autotune is not the answer. The algorithm can be fooled when cooling systems are very fast, very slow, have a large thermal lag, or have a non-linear relationship between heater power and load temperature. If a load can reach a new setpoint in under 10 sec (with an appropriate I-setting >500), the cooling system is too fast for Autotuning. Systems with a very small thermal mass can be this fast. Adding mass is a solution, but is unappealing to users who need the speed for fast cycle times. Manual tuning is not difficult on these systems because new settings can be tested very quickly. Some systems are too slow for the Autotune algorithm. Any system that takes more than 15 min to stabilize at a new setpoint is too slow (with an appropriate I-setting <5).

Thermal lag can be improved by using the sensor and heater installation techniques discussed in section 2.4 to section 2.6. Lag times up to a few seconds should be expected; much larger lags can be a problem. System nonlinearity is a problem for both autotune and manual tuning. It is most commonly noticed when controlling near the maximum or minimum temperature of a temperature control system. It is not uncommon; however, for a user to buy a cryogenic cooling system specifically to operate near its minimum temperature. If this is the case, try to tune the system at 5 degrees above the minimum temperature and gradually reduce the setpoint, manually adjusting the control settings with each step. Any time the mechanical cooling action of a cryogenic refrigerator can be seen as periodic temperature fluctuations, the mass is too small or temperature too low to autotune.

2.10 Zone Tuning

Once the PID tuning parameters have been chosen for a given setpoint, the whole process may have to be done again for other setpoints significantly far away that have different tuning needs. Trying to remember when to use which set of tuning parameters can be difficult. The Model 336 has a Zone feature as one of its tuning modes that can help.

To use the Zone feature, you must determine the best tuning parameters for each part of the temperature range of interest. Then enter the parameters into the Model 336 where up to 10 zones can be defined with different P, I, D, heater range, manual output, ramp rate, and control input settings. An upper boundary setting is assigned as the maximum temperature for that zone. The minimum temperature for a zone is the upper boundary for the previous zone, and 0 K is the starting point for the first zone. When Zone tuning is on, each time the setpoint changes, appropriate control parameters are chosen automatically. Zone tuning works best when used in conjunction with setpoint ramping (section 4.5.1.5.7).

You can determine control parameters manually or you can use the Autotune feature. Autotune is a good way to determine a set of tuning parameters for the control system that can then be entered as zones (section 2.9).

2.11 Thermoelectric Devices

A thermoelectric device, sometimes referred to as a Peltier device, or a solid state heat pump, is a device that takes advantage of the Peltier effect. When a DC current is applied to the device, heat is transferred from one side of the device to the other. Heat can be transferred in either direction by reversing the polarity of the current. Thermoelectric devices are well suited for controlling temperatures near room temperature since they have both heating and cooling capabilities. Since thermoelectric devices are solid state, they are free of the mechanical vibrations associated with mechanical coolers. Some thermoelectric coolers, in a stacked configuration, are capable of cooling devices down to cryogenic temperatures (about 100 K). These are often used to cool and maintain the temperatures of charge-coupled device (CCD) sensors.

Since thermoelectric devices are capable of both heating and cooling, they require a controller that has a bipolar output to take full advantage of this. The Model 336 can be configured for bipolar control on Output 3 or 4. Closed loop PID control works the same in bipolar mode as it does in unipolar mode except that the output can go negative instead of stopping at zero. Refer to section 5.4 to setup Output 2 in bipolar mode.

The Model 336 cannot drive a thermoelectric device directly. Most thermoelectric devices require high current (approximately 3 A) and low voltage (typically < 10 V). Output 3 or 4 are capable of ± 1 mA. An external power amplifier is necessary to boost the power up to a level that will effectively control the thermoelectric device. Refer to section 3.8.5 for more information on using an external power amplifier with Output 2.

Chapter 3: Installation

3.1 General

This chapter provides general installation instructions for the Model 336 temperature controller. Please read this entire chapter before installing the instrument and powering it on to ensure the best possible performance and maintain operator safety. For instrument operating instructions refer to Chapter 4 and Chapter 5. For computer interface installation and operation refer to Chapter 6.

3.2 Inspection and Unpacking

Inspect shipping containers for external damage before opening them. Photograph any container that has significant damage before opening it. Inspect all items for both visible and hidden damage that occurred during shipment. If there is visible damage to the contents of the container, contact the shipping company and Lake Shore immediately, preferably within five days of receipt of goods, for instructions on how to file a proper insurance claim. Lake Shore products are insured against damage during shipment, but a timely claim must be filed before Lake Shore will take further action. Procedures vary slightly with shipping companies. Keep all damaged shipping materials and contents until instructed to either return or discard them.

Open the shipping container and keep the container and shipping materials until all contents have been accounted for. Check off each item on the packing list as it is unpacked. Instruments themselves may be shipped as several parts. The items included with the Model 336 are listed below. Contact Lake Shore immediately if there is a shortage of parts or accessories. Lake Shore is not responsible for any missing items if not notified within 60 days of shipment.

If the instrument must be returned for recalibration, replacement or repair, a Return Authorization (RMA) number must be obtained from a factory representative before it is returned. Refer to section 8.14.3 for the Lake Shore RMA procedure.

Items included with Model 336 temperature controller:

- 1 Model 336 instrument
- 1 Model 336 user's manual
- 4 sensor input mating connectors, 6-pin DIN (G-106-233)
- 2 heater output connectors, dual banana, for heater Outputs 1 and 2
- 1 terminal block mating connector, 10-pin terminal block, for Outputs 3 and 4, and relays 1 and 2
- 1 line power cord
- 1 line power cord for alternative voltage*

* Included only when purchased with VAC-120-ALL power option.

3.3 Rear Panel Definition

This section provides a description of the Model 336 rear panel connections. The rear panel consists of the Input A, B, C, and D sensor input connectors (#1 in FIGURE 3-1), Output 3 and 4 analog voltage output and relays 1 and 2 terminal block connector (2), RJ-45 Ethernet connector (3), USB B-type connector (4), IEEE-488 interface connector (5), line input assembly (6), Output 1 and 2 heater output connectors (7 and 8), and the thermocouple option card inputs (9). Refer to section 8.10 for rear panel connector pin-out details.

CAUTION

Always turn off the instrument before making any rear panel connections. This is especially critical when making sensor to instrument connections.

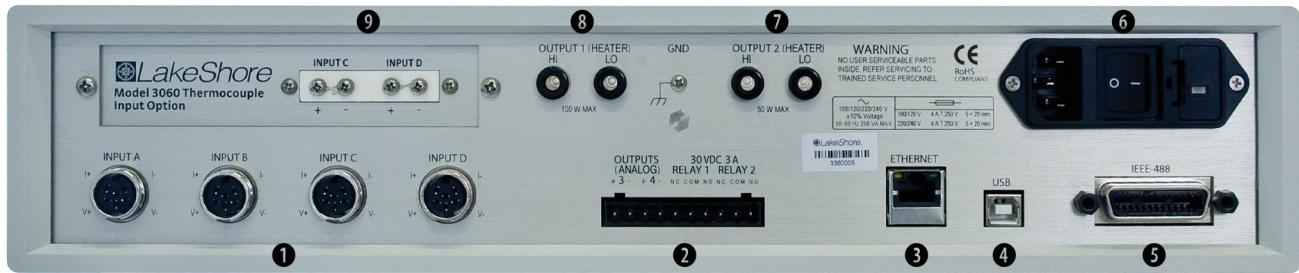

FIGURE 3-1 Model 336 rear panel

3.4 Line Input Assembly

This section describes how to properly connect the Model 336 to line power. Please follow these instructions carefully to ensure proper operation of the instrument and the safety of operators.

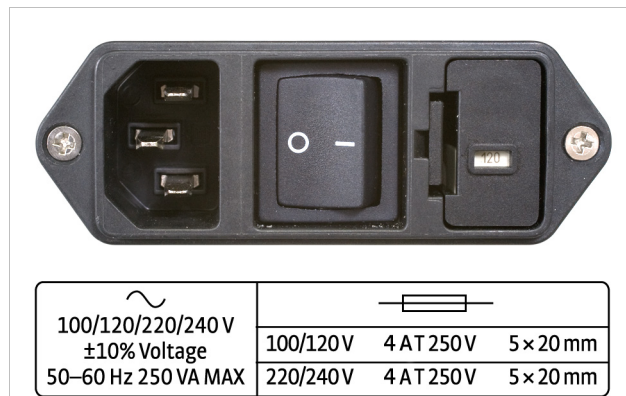

FIGURE 3-2 Line input assembly

3.4.1 Line Voltage

The Model 336 has four different AC line voltage configurations so that it can be operated from line power anywhere in the world. The nominal voltage and voltage range of each configuration is shown below. (The recommended setting for 230 V operation is 240 V.)

Nominal	Minimum	Maximum
100 V	90 V	110 V
120 V	108 V	132 V
220 V	198 V	242 V
240 V	216 V	264 V

TABLE 3-1 Line voltage

CAUTION

AC line voltage is set at Lake Shore, but it is good to verify that the AC line voltage indicator in the fuse drawer window is appropriate before turning the instrument on. The instrument may be damaged if turned on with the wrong voltage selected. Also remove and verify that the proper fuse is installed before plugging in and turning on the instrument. Refer to section 8.5 for instructions on changing the line voltage configuration.

3.4.2 Line Fuse and Fuse Holder

The line fuse is an important safety feature of the Model 336. If a fuse ever fails, it is important to replace it with the value and type indicated on the rear panel for the line voltage setting. The letter T on the fuse rating indicates that the instrument requires a time-delay or slow-blow fuse. Fuse values should be verified any time line voltage configuration is changed. Refer to section 8.6 for instructions for changing and verifying a line fuse.

3.4.3 Power Cord

The Model 336 includes a 3-conductor power cord that mates with the IEC 320-C14 line cord receptacle. Line voltage is present on the two outside conductors and the center conductor is a safety ground. The safety ground attaches to the instrument chassis and protects the user in case of a component failure. A CE approved power cord is included with instruments shipped to Europe; a domestic power cord is included with all other instruments (unless otherwise specified when ordered).



Always plug the power cord into a properly grounded receptacle to ensure safe instrument operation.

The delicate nature of measurements being taken with this instrument may necessitate additional grounding including ground strapping of the instrument chassis. In these cases the operators safety should remain the highest priority and low impedance from the instrument chassis to safety ground should always be maintained.

3.4.4 Power Switch

The power switch is part of the line input assembly on the rear panel of the Model 336 and turns line power to the instrument on and off. When the circle is depressed, power is off. When the line is depressed, power is on.

3.5 Diode/Resistor Sensor Inputs

This section details how to connect diode and resistor sensors to the Model 336 standard inputs and the Model 3062 4-channel scanner option card input channels. Refer to section 4.4 to configure the inputs. Refer to section 3.6 for a description of the optional capacitance input and section 3.7 for a description of the thermocouple input.

3.5.1 Sensor Input Connector and Pinout

The input connectors are 6-pin DIN 45322 sockets. The sensor connector pins are defined in FIGURE 3-3 and TABLE 3-2. Four mating connectors (6-pin DIN plugs) are included in the connector kit shipped with the instrument. These are common connectors, so additional mating connectors can be purchased from local electronics suppliers. They can also be ordered from Lake Shore as G-106-233.

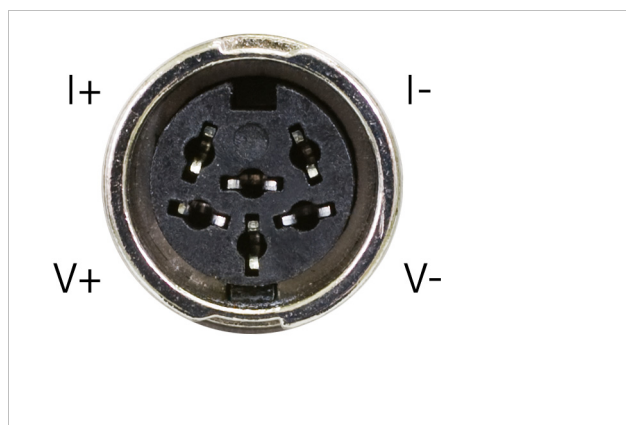

FIGURE 3-3 Sensor input connector

Pin	Symbol	Description
1	I-	-Current
2	V-	-Voltage
3	None	Shield
4	V+	+Voltage
5	I+	+Current
6	None	Shield

TABLE 3-2 Diode/resistor input connector details

3.5.2 Sensor Lead Cable

The sensor lead cable used outside the cooling system can be much different from what is used inside. Between the instrument and vacuum shroud, heat leak is not a concern. In this case, choose cabling to minimize error and noise pick up. Larger conductor, 22 AWG to 28 AWG stranded copper wire is recommended because it has low resistance yet remains flexible when several wires are bundled in a cable. The arrangement of wires in a cable is also important. For best results, voltage leads, V+ and V- should be twisted together and current leads I+ and I- should be twisted together. The twisted pairs of voltage and current leads should then be covered with a braided or foil shield that is connected to the shield pin of the instrument. This type of cable is available through local electronics suppliers. Instrument specifications are given assuming 3 m (10 ft) of sensor cable. Longer cables, 30 m (100 ft) or more, can be used, but environmental conditions may degrade accuracy and noise specifications. Refer to section 2.4.6 for information about wiring inside the cryostat.

3.5.3 Grounding and Shielding Sensor Leads

The sensor inputs are isolated from earth ground to reduce the amount of earth ground referenced noise that is present on the measurement leads. Connecting sensor leads to earth ground on the chassis of the instrument or in the cooling system will defeat that isolation. Grounding leads on more than one sensor prevents the sensor excitation current sources from operating.

Shielding the sensor lead cable is important to keep external noise from entering the measurement. A shield is most effective when it is near the measurement potential so the Model 336 offers a shield at measurement common. The shield of the sensor cable should be connected to the shield pin of the input connector. The shields should not be connected to earth ground on the instrument chassis. One shield should be connected to the cryostat's ground as long as it is near earth ground. Connecting at more than one point will cause a ground loop, which adds noise to the measurement.



The shells of the input connectors are at the same potential as the shield pin on the Model 336. Older Lake Shore controllers are not configured this way.

3.5.4 Sensor Polarity

This section describes the diode/resistor sensor inputs.

Lake Shore sensors are shipped with instructions that indicate which sensor leads are which. It is important to follow these instructions for plus and minus leads (polarity) as well as voltage and current when applicable. Diode sensors do not operate in the wrong polarity. They look like an open circuit to the instrument. Two-lead resistors can operate with any lead arrangement and the sensor instructions may not specify. Four-lead resistors can be more dependent on lead arrangement. Follow any specified lead assignment for four-lead resistors. Mixing leads could give a reading that appears correct but is not the most accurate.

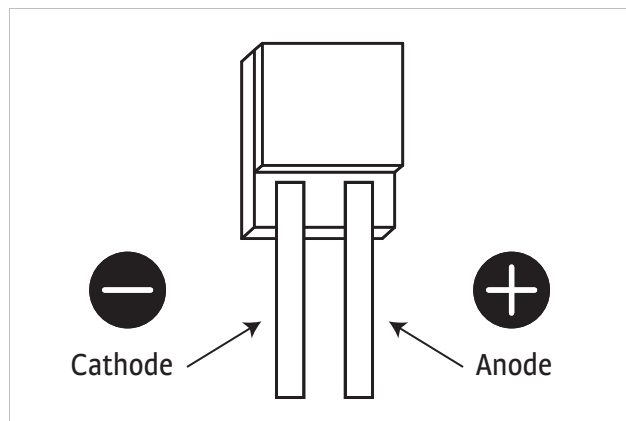

FIGURE 3-4 DT-670-SD Diode sensor leads

3.5.5 Four-Lead Sensor Measurement

All sensors, including both two-lead and four-lead can be measured with a four-lead technique. The purpose of a four-lead measurement is to eliminate the effect of lead resistance on the measurement. If it is not taken out, lead resistance is a direct error when measuring a sensor.

In a four-lead measurement, current leads and voltage leads are run separately up to the sensor. With separate leads there is little current in the voltage leads, so their resistance does not enter into the measurement. Resistance in the current leads will not change the measurement as long as the voltage compliance of the current source is not reached. When two-lead sensors are used in four-lead measurements, the short leads on the sensor have an insignificant resistance.

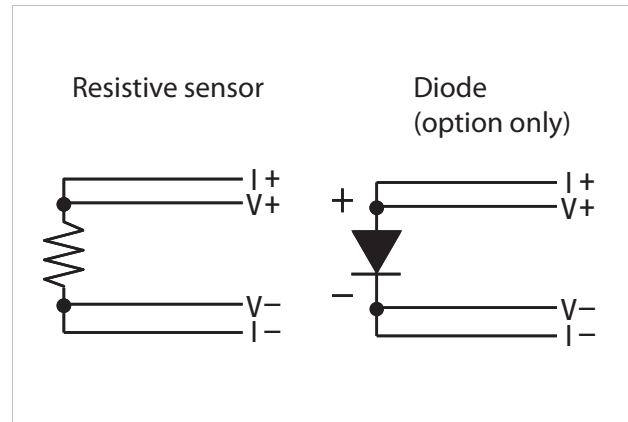

FIGURE 3-5 4-lead measurement

3.5.6 Two-Lead Sensor Measurement

There are times when crowding in a cryogenic system forces users to read sensors in a two-lead configuration because there are not enough feedthroughs or room for lead wires. If this is the case, plus voltage to plus current and minus voltage to minus current leads are attached at the back of the instrument or at the vacuum feedthrough.

The error in a resistive measurement is the resistance of the lead wire run with current and voltage together. If the leads contribute $2\ \Omega$ or $3\ \Omega$ to a $10\ \text{k}\Omega$ reading, the error can probably be tolerated. When measuring voltage for diode sensors, you can calculate the error in voltage as the lead resistance times the current, typically $10\ \mu\text{A}$.

For example: a $10\ \Omega$ lead resistance times $10\ \mu\text{A}$ results in a $0.1\ \text{mV}$ error in voltage. Given the sensitivity of a silicon diode at $4.2\ \text{K}$, the error in temperature would be only $3\ \text{mK}$. At $77\ \text{K}$ the sensitivity of a silicon diode is lower so the error would be close to $50\ \text{mK}$. Again, this may not be a problem for every user. Connectors are also a big source of error when making two-lead measurements. Connector contact resistance is unpredictable and changes with time and temperature. Minimize interconnections when making two-lead measurements. Refer to FIGURE 3-6 for an image of a two-lead sensor measurement.

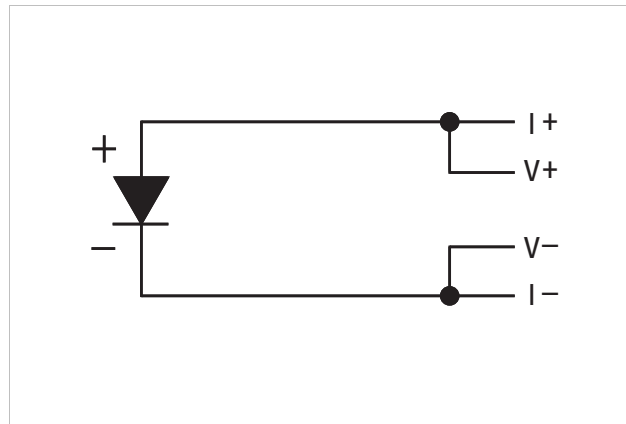

FIGURE 3-6 2-lead sensor measurement

3.5.7 Lowering Measurement Noise

Good instrument hardware setup technique is one of the least expensive ways to reduce measurement noise. The suggestions fall into two categories: (1) do not let noise from the outside enter into the measurement, and (2) let the instrument isolation and other hardware features work to their best advantage. Here are some further suggestions:

- Use four-lead measurement whenever possible
- Do not connect sensor leads to chassis or earth ground
- Use twisted shielded cable outside the cooling system
- Attach the shield pin on the sensor connector to the cable shield
- Do not attach more than one cable shield at the other end of the cable
- Run different inputs and outputs in their own shielded cable
- Use twisted wire inside the cooling system
- Use similar technique for heater leads
- Use a grounded receptacle for the instrument power cord
- Consider ground strapping the instrument chassis to other instruments or computers

3.6 Capacitance Sensor Inputs (Model 3061)

This section provides information for a Model 336 configured with the capacitance sensor input option card. Capacitance inputs are not installed on the standard Model 336, but it can be added by purchasing the Model 3061 capacitance input option. Refer to section 7.6 for installation of the Model 3061.

The Model 3061 adds a capacitance input to the Model 336, appearing on the display as input D. The card has separate voltage feedback and current excitation for the sensor. The Model 3061 is intended to control temperature in strong magnetic fields using a Lake Shore Model CS-501 capacitance temperature sensor. The standard inputs remain in the instrument and are fully functional.



Upon changing control to the capacitive sensor, the PID values will need to be optimized.

The Model 336 does not support temperature conversion for the capacitance input. The temperature response of capacitance sensors shifts with thermal cycling, making calibration unpredictable. All Model 3061 option measurement and control must be done in sensor units. With this option, two sensors should be installed at the control point. Use a resistive sensor in one of the standard inputs to establish a control temperature and stabilize the system in a low magnetic field. Before increasing the field strength, shift control to the capacitance sensor to maintain the current temperature.

3.6.1 Wiring, Guarding and Shielding

The capacitance input uses the same 6-pin din connector as the standard inputs, and the same pins for current excitation and voltage feedback. Cable capacitance in longer cables can cause large sensor reading errors if proper guarding and shielding methods are not applied. To address this problem, a driven guard is provided on pin 6, and a shield pin is provided on pin 3. The guard pin should be connected to a foil shield that surrounds a single twisted pair of wires used for I+ and V+. The shield pin on pin 3 should be connected to a foil shield that surrounds a single twisted pair of wires used for I- and V-. See FIGURE 3-7. This wiring scheme must be applied to ensure proper sensor readings using the Model 3061 capacitance option

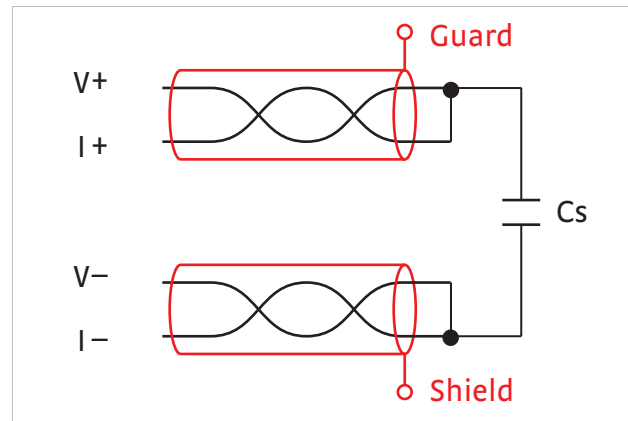

FIGURE 3-7 Capacitance Input shield and gard

NOTE

The 3.496 kHz excitation of the option card can interfere with the sensitive DC measurements of the standard inputs. Tightly twist the lead wires of each sensor and separate them from the leads from the other sensor. Test any system for sensor interference before it is permanently sealed

3.7 Thermocouple Sensor Inputs (Thermocouple Model 3060)

NOTE

Do not leave thermocouple inputs unconnected. Short inputs when not in use.

3.7.1 Sensor Input Terminals

Attach sensor leads to the screws on the off-white ceramic terminal blocks. Sensor connection is important when using thermocouples because the measured signal is small. Many measurement errors can be avoided with proper sensor installation. The block has two thermocouple inputs and each input has two screw terminals; one positive, one negative. See FIGURE 3-8.

Remove all insulation, then tighten the screws on the thermocouple wires. Keep the ceramic terminal blocks away from heat sources including sunlight and shield them from fans or room drafts.

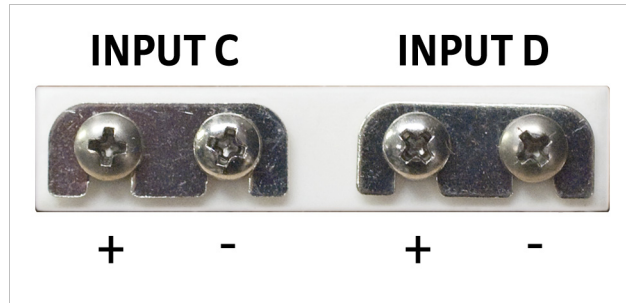

FIGURE 3-8 Thermocouple input definition and common connector polarities (inputs shown shorted)

3.7.2 Thermocouple Installation

Thermocouples are commonly used in high-temperature applications. Cryogenic use of thermocouples offers some unique challenges. A general installation guideline is provided in section 2.4. Consider the following when using thermocouples at low temperatures:

- Thermocouple wire is generally more thermally conductive than other sensor lead wire. Smaller gauge wire and more thermal anchoring may be needed to prevent leads from heating the sample.
- Attaching lead wires and passing them through vacuum tight connectors is often necessary in cryogenic systems. Remember, the thermocouple wire is the sensor; any time it joins or contacts other metal, there is potential for error.
- Temperature verification and calibration of room temperature compensation is difficult after the sensor is installed. When possible, keep a piece of scrap wire from each installation for future use.
- Thermocouples can be spot-welded to the cryostat for good thermal anchoring as long as the cryostat has a potential close to earth ground.

3.7.3 Grounding and Shielding

Care must be taken to minimize the amount of noise contributed by ground loops, when grounding thermocouple inputs. For lowest measurement noise, do not ground thermocouple sensors. The instrument operates with slightly more noise if one of the thermocouples is grounded. Be sure to minimize loop area when grounding both thermocouples. The instrument does not offer a shield connection on the terminal block. Twisting the thermocouple wires helps reject noise. If shielding is necessary, extend the shield from the oven or cryostat to cover the thermocouple wire, but do not attach the shield to the instrument.

3.8 Heater Output Setup

The following section covers the heater wiring from the vacuum shroud to the instrument for both heater outputs. Specifications are detailed in section 1.3. For help on choosing and installing an appropriate resistive heater, refer to section 2.5.

3.8.1 Heater Output Description

Both powered heater outputs (Outputs 1 and 2) are traditional control outputs for a cryogenic temperature controller. Both are variable DC current sources with software settable ranges and limits. Both are configurable for optimization using either a 25 Ω or a 50 Ω heater resistance. At the 50 Ω setting, both outputs are limited to a maximum output current of 1 A. At the 25 Ω setting, the maximum heater output current is 2 A for Output 1, and 1.41 A for Output 2. The compliance voltage of each output is 50 V minimum, but can reach as high as 58 V if the heater resistance is higher than the nominal setting. Heater power is applied in one of three ranges: high, med, or low. Each range is one decade lower in power. Refer to TABLE 4-14 for maximum current and power ratings into different heater resistance.

3.8.2 Heater Output Connectors

Dual banana jacks on the rear panel of the instrument are used for connecting wires to the heater outputs. Two standard dual banana plug mating connectors are included in the connector kit shipped with the instrument. This is a common jack and additional mating connectors can be purchased from local electronic suppliers, or from Lake Shore as P/N 106-009. The heater is connected between the HI and LO terminals.

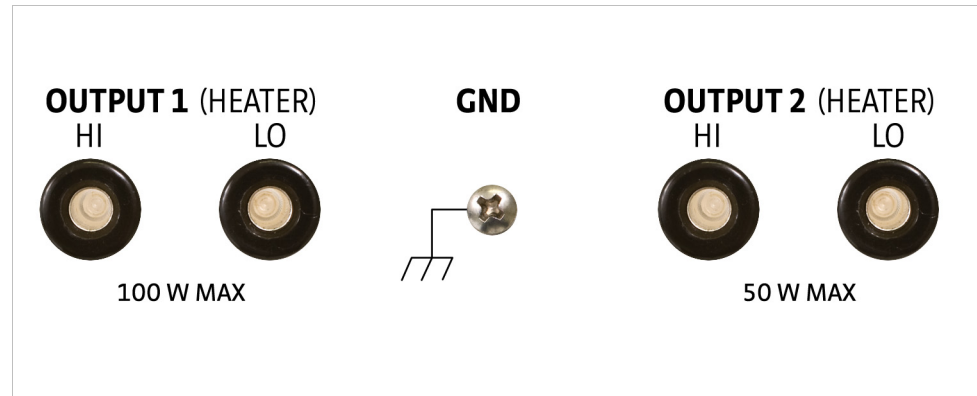

FIGURE 3-9 Rear panel showing heater output connectors

3.8.3 Heater Output Wiring

Heater output current is what determines the size (gauge) of wire needed to connect the heater. The maximum current that can be sourced from heater Output 1 is 2 A. When less current is needed to power a cooling system, it can be limited with range settings.

When setting up a temperature control system, the lead wire for the heater must be capable of carrying a continuous current that is greater than the maximum current. Wire manufacturers recommend 26 AWG or larger wire to carry 2 A of current, but there is little advantage in using wire smaller than 20 AWG to 22 AWG outside the cryostat. Inside the cryostat, smaller gauge wire is often desirable.

It is recommended to use twisted heater leads. Large changes in heater current can induce noise in measurement leads and twisting reduces the effect. It is also recommended to run heater leads in a separate cable from the measurement leads to further reduce interaction.

There is a chassis ground point at the rear panel of the instrument for shielding the heater cable if necessary. The cable shield can be tied to this point using a 3.18 mm (#4) spade terminal, or ring connector. The shield should not be connected at the opposite end of the cable and should never be tied to the heater output leads.

For best noise performance, do not connect the resistive heater or its leads to ground. Also avoid connecting heater leads to sensor leads or any other instrument inputs or outputs.

3.8.4 Heater Output Noise

The heater output circuitry in the Model 336 is capable of sourcing 100 W of power. This type of circuitry can generate some electrical noise. The Model 336 was designed to generate as little noise as possible, but even noise that is a small percentage of the output voltage or current can be too much when sensitive measurements are being made near by.

3.8.5 Powering Outputs 3 and 4 Using an External Power Supply

Outputs 3 and 4 cannot power heaters directly when used in warm up control mode. These unpowered outputs must be used to program an external power supply which in turn powers the heater. This section describes choosing and installing an external supply. Section 5.5 describes operation of warm up control mode.

3.8.5.1 Choosing a Power Supply

- *Voltage Programmable:* the power supply must be voltage programmable so that Outputs 3 or 4 (control output) can control it. Ideally the supply's programming input should have a range of 0 to 10 V that corresponds to 0 to 10 V range of the control output. This guarantees that 0 to 100% of the control output scales to 0 to 100% power out of the supply. Supplies with different programming input ranges can be used as described in section 3.8.5.4.
- *DC Output Capable:* the power supply must be capable of continuous DC output. Most commercial audio amplifiers are not suitable because they are AC coupled and cannot provide a DC output.
- *Output Type:* most available voltage programmable power supplies are configured for voltage output. This is different than Outputs 1 and 2 on the 336 which are configured for current output. The differences between the two are not significant when used in warm up mode.
- *Output Voltage:* Lake Shore recommends supplies with a working output voltage between 10 V and 50 V. Voltage higher than 50 V poses a shock hazard and should only be used if operator safety can be assured by the installer. Voltage lower than 10 V becomes impractical because the current necessary provide any meaningful power is too high for most cryogenic wiring.
- *Output Power:* there is no limit to the maximum power of the supply. Typical warm up applications normally range between 25 W and 200 W.

3.8.5.2 Power Supply Setup

Follow all operation and safety instruction in the power supply manual during setup. Consider the following suggestions for protecting the power supply and heater load.

- Short circuits are common in cryogenic lead wiring. If the power supply does not specify that it is short circuit protected the power output should be wired with a fuse in series to prevent damage.
- Unipolar power supplies are designed to use a positive programming voltage and some can be damaged if the programming voltage is negative. Be careful when wiring the system to maintain the correct polarity. Also, never set the control output of the Model 336 to bipolar mode.
- Some power supplies can be damaged if there is a programming voltage present at their input when they are turned off. This can happen if the Model 336 and power supply use a different source of line power or are turned on and off individually. It can be avoided if the two instruments share a switched power strip.
- The heater and wiring in the system must be rated for both the maximum current and maximum voltage provided by the power supply. The Model 336 can be set to warm up using less than full power if the load will not tolerate the full power of the supply.

3.8.5.3 Connecting to the Model 336

The voltage programming cable attaches to the removable terminal block on the rear panel of the Model 336 (FIGURE 3-10). Output number and polarity of the output leads are indicated on the silk screen. The negative (–) terminals are connected internally to the instrument chassis to provide a ground reference.

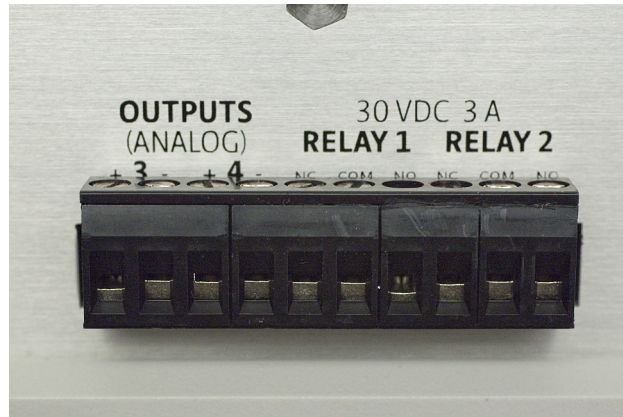

FIGURE 3-10 Output terminal block

In the most basic configuration, a two-conductor cable connects directly from the output terminals to the power supply programming input. Copper wire size 20 AWG to 26 AWG is recommended.

3.8.5.4 Programming Voltages Under 10 V

A voltage divider FIGURE 3-11 can be used to reduce the control output voltage if the programming input of the power supply has a range of less than 0 V to 10 V to ensure full output resolution, and protection against overloading the external supply programming inputs. The output voltage is proportional to the ratio of resistors R1 to R2: $V_{out} = 10V \times R1/(R1+R2)$. It is also important to keep the sum of $R1 + R2 > 1000 \Omega$ or the Model 336 output may not reach the output voltage setting due to internal overload protection. For a programming input range of 0 V to 5 V, recommended values are: $R1 = R2 = 2000 \Omega$. For a programming input range of 0 V to 1 V, recommended values are: $R1 = 500 \Omega$, $R2 = 4500 \Omega$. Exact resistor value, type and tolerance are generally not important for this application.

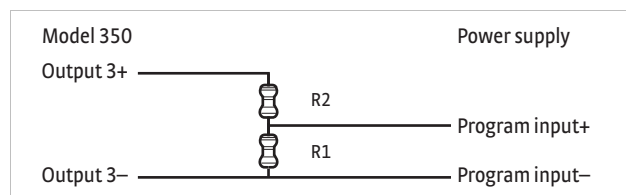

FIGURE 3-11 Voltage divider circuit for Output 3

Chapter 4: Operation

4.1 General

This chapter provides instructions for the general operating features of the Model 336 temperature controller. Advanced operation is in Chapter 5. Computer interface instructions are in Chapter 6.

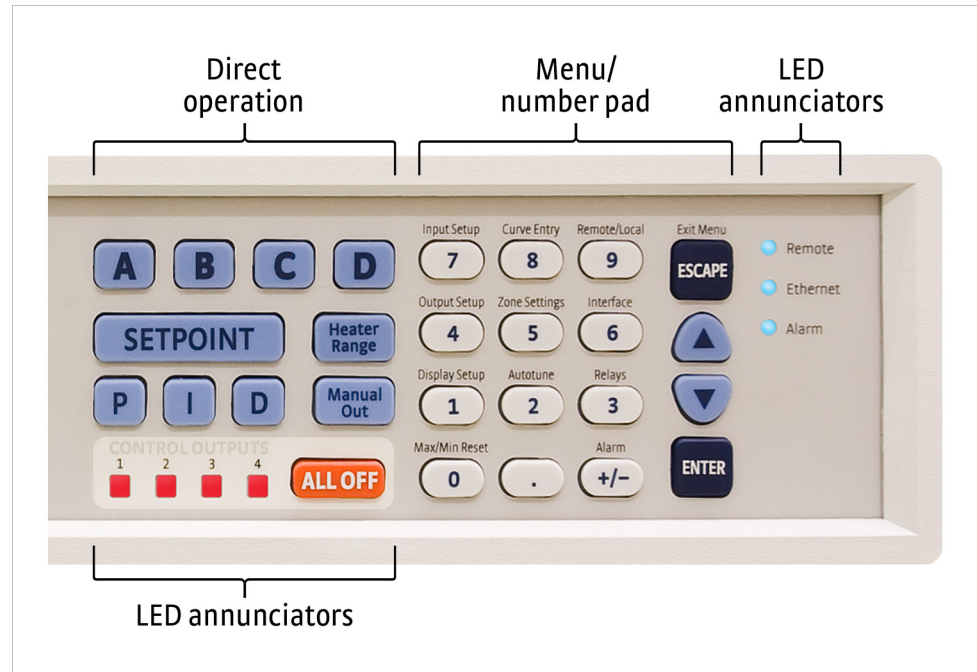

FIGURE 4-1 Model 336 front panel

4.1.1 Understanding Menu Navigation

Each feature that is discussed in this chapter will include a menu navigation section. This section is intended to be a quick guide through the necessary key presses to arrive at and set the desired features. See FIGURE 4-2 and TABLE 4-1 for an explanation of the conventions used in the menu navigation.

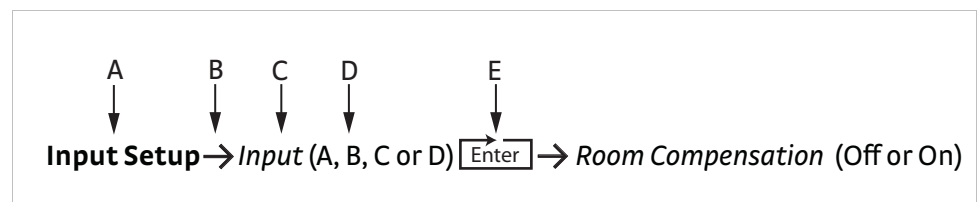

FIGURE 4-2 Menu navigation example

Item	Convention	Explanation
A	Bold	Typically, the first word in the menu navigation is in bold type, which indicates the first key you will need to press.
B	→	The arrow indicates that the screen is advancing to the next screen. In the menu navigation, the item that follows the arrow is the next item you would see on the screen or the next action that you will need to perform.
C	<i>Italic type</i>	Often, the words that follow the arrow are in italic type. The italic type indicates that there is a setting that needs to be selected.
D	(Parentheses)	The items that follow the italicized word and which are in parentheses, are the available selections to which you can set the desired feature.
E	Enter	Press Enter on the keypad.

TABLE 4-1 Menu navigation key

4.2 Front Panel Description

This section provides a description of the front panel controls and indicators for the Model 336.

4.2.1 Keypad Definitions

The keypad is divided into two sections. The Direct Operation section includes all keys to the left of the number-pad, and the Menu/Number Pad section includes the standard 12 number-pad keys and the **Up**, **Down**, **Escape**, and **Enter** keys (FIGURE 4-1). The Direct Operation keys provide one touch access to the most often used functions of the Model 336. The Number Pad keys, with the exception of the decimal point key, are dual function keys. If the instrument is in the number entry mode, the keys are used to enter numbers. If it is in normal operating mode, the number keys provide menu entry points. An abbreviated description of each key is provided as follows. A more detailed description of each function is provided in section 4.3 to section 4.5.

4.2.1.1 Direct Operation Keys

Key	Function	Refer to section:
A, B, C, and D	Press these keys for quick access to the display screens for the associated sensor input, or Input Display mode. Press once for a temporary display that will time-out in 10 s, at which point the display returns to the assigned Display Mode setting. Press the same key again, or press Escape before the timeout period, to return the display to the previous Display Mode setting. Pressing and holding one of these keys for 3 s causes the associated Input Display to become the new permanent Display Mode setting, indicated by an audible beep. When the Model 3062 4-channel scanner option is installed, pressing the D button cycles the display through the display screens for each of the 5 input D channels.	4.3.1.3
Setpoint	Press this key to enter the control setpoint for the currently displayed loop, if applicable.	4.5.1.5.6
Proportional (P)	Press this key to manually adjust the Proportional control parameter for the currently displayed loop, if applicable.	4.5.1.5.2
Integral (I)	Press this key to manually adjust the Integral control parameter for the currently displayed loop, if applicable.	4.5.1.5.3
Derivative (D)	Press this key to manually adjust the Derivative control parameter for the currently displayed loop, if applicable.	4.5.1.5.4
Heater Range	For Outputs 1 and 2, this key allows selection of High, Med, or Low heater range. For Outputs 3 and 4, this key allows selection of Output On/Off (except when in Monitor Out mode).	4.5.1.5.8
Manual Out	Press this key to adjust the Manual Output setting of the currently displayed output, if applicable.	4.5.1.5.5
All Off	Press this key to set the range for all Outputs to Off (not applicable for Monitor Out mode).	4.5

TABLE 4-2 *Direct operation keys*

4.2.1.2 Menu/Number Pad Keys

Key	Function	Refer to section
Input setup	Press this key to configure features related to the inputs.	4.4 for sensor input setup 4.4.9 for curve selection.
Output setup	Press this key to configure features related to the outputs, including configuration of control loops.	4.5
Display setup	Press this key to configure the display.	4.3
Max/Min reset	Press this key to reset the maximum and minimum readings for all inputs.	4.4.14
Curve entry	Press this key to view, edit, copy, and erase temperature curves, and to generate SoftCal curves.	Section 5.2 Front Panel Curve Entry Operations.
Zone settings	Press this key to enter user-specified control parameters for up to ten temperature zones.	5.3.
Autotune	Press this key to configure and execute the Autotune algorithm.	5.2.
Remote/local	Press this key to toggle the IEEE-488 Remote mode.	4.6.3.1
Interface	Press this key to configure the USB, Ethernet, and IEEE-488 interfaces.	4.6.1 for USB; 4.6.2 for Ethernet; 4.6.3 for IEEE-488
Relays	Press this key to configure the two rear-panel relays.	5.7.2.
Alarm	Press this key to configure the Alarm feature.	5.7.1.
▲	Press this key to navigate menus, and to select parameters.	N/A
▼	Press this key to navigate menus, and to select parameters.	N/A
Escape (exit menu)	Press this key to cancel a number entry, or parameter selection. You can also use this key to navigate up one level in a setting menu, which exits the menu if at the top level. Press and hold for 3 s to reset instrument parameters to factory default values.	N/A
Enter	Press this key to accept a number entry, or a parameter selection. You can also use it to navigate deeper into a menu setting screen. Press and hold for 3 s to lock or unlock the keypad.	N/A
0–9, +/,-,.	Press this key to enter numeric data. This includes a key to toggle plus (+) or minus (-), and a key for entry of a decimal point.	4.2.3.

TABLE 4-3 Menu/number pad keys

4.2.2 Annunciators

LED annunciators: three blue four red LED annunciators are included to provide visual feedback of the following operation.

LED	Function	Refer to section
Remote	On steady when the instrument is in Remote mode (may be controlled via the IEEE-488 Interface). If the LED is not illuminated, the instrument is in Local mode.	4.6.3.1
Ethernet	On steady when Ethernet is connected and properly configured. Blinks at a slow pace when attempting to acquire an IP address. Blinks rapidly when in an error state.	4.6.2
Alarm	On steady when the alarm feature for any sensor input is turned on and the input's Visual parameter is set to On. Blinks when any input sensor alarms are in the alarming state and the alarming input's Visual parameter is set to On.	5.7
Control outputs	On steady when the corresponding output is in the On state (does not apply to Monitor Out mode). Off when corresponding output is in the Off state, or when it is set to Monitor Out mode.	4.5.1.4

TABLE 4-4 LED annunciators

Display annunciators: include symbols for sensor inputs and their respective temperatures and units.

Annunciator	Function
A	Sensor input A
B	Sensor input B
C	Sensor input C
D	Sensor input D
D1	Sensor input D, channel 1
D2	Sensor input D, channel 2
D3	Sensor input D, channel 3
D4	Sensor input D, channel 4
D5	Sensor input D, channel 5
K	Temperature in kelvin
C	Temperature in degrees Celsius
V	Sensor units of volts
Ω	Sensor units of ohms
kΩ	Sensor units of kilohms
mV	Sensor units of millivolts

TABLE 4-5 *Display annunciators*

4.2.3 General Keypad Operation

There are five basic keypad operations: direct operation, menu navigation, number entry, alpha-numeric entry and setting selection.

- *Direct Operation*: the key function occurs as soon as you press the key; these include the **Setpoint**, **P**, **I**, **D**, **Manual Out**, and **All Off** keys.
- *Menu Navigation*: each menu has a list of configurable parameters. Menus that apply to multiple entities (for example, Input Setup could apply to Input A, B, C, or D) have a first level selection to determine which entity to configure (for instance, Input C). Once the first level selection is made, the list of menu parameters is displayed. The parameter labels are displayed on the left, and the current value of each parameter is displayed on the right. In this screen, use the ▲ and ▼ keys to move the highlight up or down, respectively. Press **Enter** to enter the setting mode for the highlighted parameter. The type of setting mode depends on the type of parameter highlighted. The possible setting modes are: Number Entry, Alpha-Numeric Entry, and Setting Selection. Refer to the respective entry mode descriptions below. During menu navigation, press **Escape** (Exit Menu) to perform the Exit Menu function; this will not cancel any setting changes.
- *Number Entry*: allows you to enter number data using the number pad keys. Number pad keys include the numbers 0–9, +/-, and the decimal point. The proportional control parameter is an example of a parameter that requires number entry. During a number entry sequence use the number entry keys to enter the number value, press **Enter** to accept the new data. Press **Escape** once to clear the entry, and twice to return to the Menu Navigation mode.
- *Alpha-Numeric Entry*: allows you to enter character data using the number pad keys, and the ▲ and ▼ keys. The input sensor name is an example of a parameter that requires Alpha-Numeric Entry. Press ▲ or ▼ to cycle through the upper and lower case English alphabet, numerals 0 through 9, and a small selection of common symbols. Press **Enter** to advance the cursor to the next position, or to save the string and return from Alpha-Numeric Entry mode if in the last position. Press **Escape** to move the cursor back one position, or to cancel all changes and return from Alpha-Numeric Entry mode if at the first position. Press any of the number pad keys, except for +/-, to enter that character into the string and advance the cursor to the next position automatically, or to save the string and return to Menu Navigation mode if in the last position. Use the +/- key to enter the whitespace character.

- **Setting Selection:** allows you to select from a list of values. During a selection sequence, use the ▲ or ▼ keys to select a parameter value. To select the highlighted parameter as the new setting, press Enter; the setting is saved and the mode returns to Menu Navigation. Press Escape at any time while the parameter list is displayed to cancel any changes and return to Menu Navigation mode.

4.3 Display Setup

The intuitive front panel layout and keypad logic, bright, graphic display, and LED indicators enhance the user-friendly front panel interface of the Model 336. The Model 336 offers a bright, graphic, liquid, crystal display, with an LED backlight that simultaneously displays up to eight readings.

4.3.1 Display Modes

The Model 336 provides several display modes designed to accommodate different instrument configurations and user preferences. The Four Loop display mode offers large format sensor readings of each of the four sensor inputs, as well as setpoint and heater output information for associated outputs, all on one screen. The Input display modes provide detailed information about the relevant sensor input, and the associated output. The Custom display mode provides a means for you to assign different types of information to specific sections of the display.

Menu Navigation:

Display Setup → Display Mode → (Four Loop, Custom, Input A, Input B, Input C, Input D)

Default: Custom

Interface Command: DISPLAY

4.3.1.1 Four Loop Mode

Four Loop mode provides a limited amount of information about each of the four sensor inputs, and the associated control loops. Each quadrant of the display is dedicated to one sensor input and the associated loop, if applicable. The top line of each quadrant contains the input letter (A, B, C, or D) followed by the user-assignable sensor name. The sensor readings are presented just below the sensor name in the large character format for easier viewing from a distance. The sensor reading is displayed in the units assigned to the respective sensor input's Preferred Units setting, which can be found under the Input Setup menu (section 4.4). If the input is assigned as the Control Input of a control loop, then the control Setpoint and Heater Output parameters are displayed under the sensor reading. If the output is in Open Loop mode, then the Setpoint parameter is not shown.

Menu Navigation:

Display Setup → Display Mode → Four Loop Mode

Interface Command: DISPLAY



FIGURE 4-3 Four loop mode

4.3.1.2 All Inputs Mode

All Inputs mode is available only when a model 3062 option is installed. It provides a limited amount of information about each of the sensor inputs. Similar to the Four Loop mode, each quadrant of the display is dedicated to one sensor input with the input letter being displayed, followed by the user-assignable input name. The sensor reading is displayed in large character format, using the units assigned to the respective input's Input Units parameter. All eight sensor inputs and channels are displayed, and the display mode can be configured as large or small. When it is configured as large, the input name is not shown and the sensor reading is displayed in large character format. When it is configured as small, the input name is shown and the sensor reading is displayed in the normal smaller character format.

Menu Navigation:

Display Setup→*Display Mode*→All Inputs Mode

Interface Command: **DISPLAY**

4.3.1.3 Input Display Modes

An Input Display mode exists for each of the four sensor inputs on the Model 336. These modes are referenced as Input A, Input B, Input C, and Input D in the Display Mode parameter list. Each of these modes provides detailed information relevant to the respective sensor input.



FIGURE 4-4 *Input display mode*

The top half of the display provides information related to the sensor input. The input letter is displayed, followed by the user-assignable input name. The sensor reading is displayed in large character format, using the units assigned to the respective input's Input Units parameter. The top half of the display also shows the maximum and the minimum sensor reading since the last Max/Min reset.

The bottom half of the display contains information related to the control loop that is using the sensor input (provided in the top half of the display) as its Control Input parameter. Only the items applicable to the control loop will be displayed. Specifically, the number of the control loop output, followed by the Output Mode setting is displayed. The P, I, D, Manual Output, Setpoint, and Heater Output information of the control loop are also displayed. If no control loop uses the sensor input, then no information is applicable.

The input display modes are unique in that they can be set temporarily by pressing the A, B, C, or D front panel keys. After the key is pressed, the respective input display mode becomes active for approximately 10 s before returning to the configured display mode. This provides quick access to each input and each associated control loop for gathering information, or changing control loop parameters. Press any active keys while the temporary display mode is active to reset the timeout period of the temporary display. Press **Escape**, or the same temporary display key again, to manually return the display to the configured display mode. Press and hold a temporary display key until an audible beep is heard (about 3 s) to cause the configured display mode to change to the input display mode associated with that key.

Menu Navigation:

Display Setup→*Display Mode*→Input (A, B, C, D)

(Each input can also be accessed by pressing and holding A, B, C, or D.)

Interface Command: **DISPLAY**

4.3.1.4 Custom Display Mode

The custom display mode provides the ability to customize the displayed front panel information to your preference. As with the input display modes, the custom display mode shows sensor input information in the top half of the screen, and control loop information in the bottom half. The sensor input information can be customized to display two large character sensor readings with names, four large character sensor readings without names, or eight small character format sensor readings without names. Each displayed reading can use any sensor as the input, and can be displayed in units of kelvin, Celsius, sensor, min, or max.

Menu Navigation:

Display Setup→Display Mode→Custom

Interface Command: DISPLAY

- *Locations:* depending on the Number of Displays parameter, there can be anywhere from two to eight display locations for displaying sensor readings. The placement of a given display location on the front panel LCD depends on the Number of Displays setting (FIGURE 4-5).

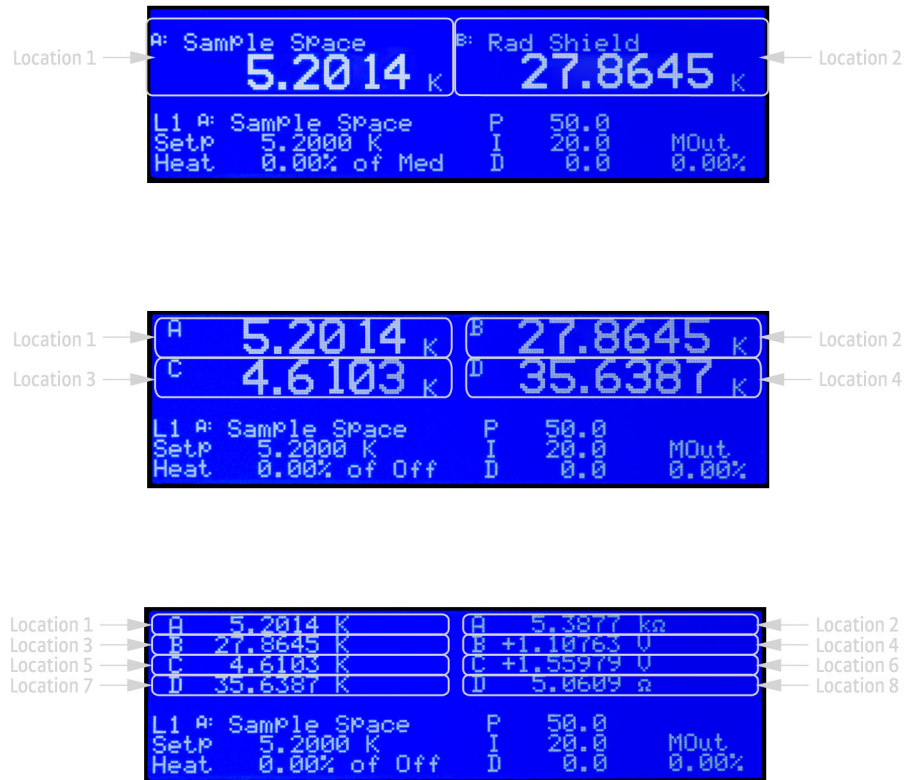

FIGURE 4-5 Top to bottom: Model 336 screen images showing 2, 4 and 8 display locations

- *Number of Custom display locations:* the Number of Displays parameter determines how many sensor readings are displayed, as well as the character size of the displayed readings. If “2 (Large)” is selected, then two large character readings are displayed, along with sensor names. If “4 (Large)” is selected, then four large character readings are displayed, without sensor names. If “8 (Small)” is selected, then eight small character readings are displayed, without sensor names.

Menu Navigation:

Display Setup→Number of Locations→(2 Large, 4 Large, 8 Small)

- **Input and Units:** each available display location has an associated Input and Units setting. The Input parameter determines which sensor will be used as the input of the displayed data. The Input can be any of the four sensor inputs, or None. If None is selected, then the display location will be blank. The Units parameter determines which units to display the reading in.

Menu Navigation:

Display Setup→*Location* (1, 2, 3, 4, 5, 6, 7, 8) *Input*→(None, Input A, Input B, Input C, Input D)

Display Setup→*Location* (1, 2, 3, 4, 5, 6, 7, 8) *Units*→(Kelvin, Celsius, Sensor, Min, Max, Sensor Name)

Interface Command: **DISPFLD**

Location	Input	Units
1	Input A	Kelvin
2	Input B	
3	Input C	
4	Input D	
5	Input A	Sensor
6	Input B	
7	Input C	
8	Input D	

TABLE 4-6 Defaults

- **Displayed Output:** in the Custom Display mode the bottom half of the display is dedicated for output and control loop information for one of the four outputs. The source of this information depends on the output selected for the Displayed Output parameter. If the selected output is configured as a control loop output, then all associated control loop parameters will be displayed.

When viewing the Custom Display screen, the configured Displayed Output is signified by L1, L2, L3 or L4, followed by the control loop input, if applicable. The L character stands for Loop, but will be displayed even for outputs that are not configured as control loop outputs.

Menu Navigation:

Display Setup→*Displayed Output*→Output (1, 2, 3, 4)

- Default: Output 1
Interface Command: **DISPLAY**

4.3.2 Display Contrast

The front panel LCD display contrast can be adjusted for optimal viewing. The default value should work well in most standard room temperature environments, but deviations from room temperature, and extreme viewing angles can cause the display contrast to require adjustment for optimal viewing.

Menu Navigation:

Display Setup→**Display Contrast**→(1 to 32)

Default: 28

Interface Command: **BRIGT**

4.4 Input Setup

The Model 336 supports a variety of temperature sensors manufactured by Lake Shore and other manufacturers. An appropriate sensor type must be selected for each input. If the exact sensor model is not shown, use the sensor input performance chart in TABLE 4-7 to choose an input type with similar range and excitation. For additional details on sensors, refer to the Lake Shore Temperature Measurement and Control Catalog or visit our website at www.lakeshore.com.



Any unused input should be set to disabled.

Sensor Type	Display Message	Input Range	Excitation	Coefficient	Curve Format	Lake Shore Sensors*
Silicon Diode	Diode	0 V–2.5 V	10 μ A, 1 mA	Negative	V/K	DT-400 Series, DT-500, DT-670 Series
Gallium Aluminum Arsenide Diode	Diode	0 V–10 V	10 μ A, 1 mA	Negative	V/K	TG-120 Series
Platinum RTD, Rhodium-Iron RTD	PTC RTD (Platinum)	0 Ω to 10 k Ω (7 ranges)	1 mA	Positive	Ω /K	PT-100 Series Platinum, RF-800 Rhodium-Iron, RF-100 Rhodium-Iron
Negative Temperature Coefficient (NTC) RTD	NTC RTD (Cernox™)	0 Ω to 100 k Ω (9 Ranges)	100 nA to 1 mA (decade steps in power, autorange maintains <10 mV)	Negative	log Ω /K	Cernox™, Carbon Glass, Germanium, Rox™, and ThermoX™
Thermocouple (Option 3060 only)	Thermocouple	\pm 50 mV	NA	Positive	mV/K	Chromel-AuFe (0.07%), Type E (Chromel-Constantan), Type K (Chromel-Alumel), Type T (Copper-Constantan)

Refer to the Lake Shore Temperature Measurement and Control Catalog for details on Lake Shore temperature sensors.

TABLE 4-7 Sensor input types

Menu Navigation:

Input Setup→**Input (A, B, C, or D)**→**Sensor Type**→(Disabled, Diode, PTC RTD [Platinum], NTC RTD [Cernox], Thermocouple)

Default: Diode

Interface Command: **INTYPE**

4.4.1 Diode Sensor Input Setup

Diode sensors include the silicon and the gallium aluminum arsenide sensors detailed in TABLE 4-7. Input ranges are selectable to 0–2.5 V or 0–10 V, and standard excitation current is 10 μ A.

As an alternative to the standard diode excitation current of 10 μ A, you may select a 1 mA excitation. The 1 mA excitation current is not calibrated, and will not work properly with standard Lake Shore diode sensors. For protection against accidentally setting the 1 mA excitation current, the Diode Current setting is automatically set to 10 μ A every time the Sensor Type is set to Diode.

Menu Navigation:

Input Setup→*Input (A, B, C, or D)*→*Sensor Type*→Diode

Input Setup→*Input (A, B, C or D)*→*Diode Current*→(10 μ A or 1 mA)

Input Setup→*Input (A, B, C or D)*→*Range*→(2.5 V [Silicon] or 10 V [GaAlAs])

Default: *Sensor Type*→Diode

Diode Current→10 μ A

Range→2.5 V (Silicon)

Interface Command: **INTYPE**, **DIOCUR**

4.4.2 Positive Temperature Coefficient (PTC) Resistor Sensor Input Setup

PTC resistor sensors include the platinum and rhodium-iron sensors detailed in TABLE 4-7. More detailed specifications are provided in TABLE 1-2. The Model 336 supplies a 1 mA excitation current for the PTC resistor sensor type. A resistance range selection is available in order to achieve better reading resolution. Autorange is enabled by default in order to provide the best possible reading resolution, but does not affect the sensor current excitation. Refer to section 4.4.4 for details on manually selecting the range. Current Reversal is also enabled by default in order to compensate for thermal EMF voltages. Refer to section 4.4.5 for details on the Thermal EMF Compensation (Current Reversal) feature.

Menu Navigation:

Input Setup→*Input (A, B, C, or D)*→*Sensor Type*→PTC RTD (Platinum)

Interface Command: **INTYPE**

4.4.3 Negative Temperature Coefficient (NTC) Resistor Sensor Input Setup

NTC resistor sensors include Cernox™, Rox, Thermox and others detailed in TABLE 4-7. More detailed specifications are provided in TABLE 1-2. The excitation current for the NTC RTD sensor type can vary between 100 nA and 1 mA, depending on resistance range. When autoranging is enabled, the range will be automatically selected so that the excitation voltage is below 10 mV. This keeps the power dissipated in the sensor at a minimum, yet still enough to provide accurate measurements. Current Reversal is also enabled by default in order to compensate for thermal EMF voltages. Refer to section 4.4.5 for details on the Thermal EMF Compensation (Current Reversal) feature.

Menu Navigation:

Input Setup→*Input (A, B, C, or D)*→*Sensor Type*→NTC RTD (Cernox)

Interface Command: **INTYPE**

4.4.4 Range Selection

The Model 336 is equipped with an autoranging feature that will automatically select the appropriate resistance range for the connected resistive temperature device. In some cases it may be desirable to manually select the resistance range. To manually select a resistance range, set the Autorange parameter to Off, then use the Range parameter to select the desired range. Autorange will be On by default whenever the Sensor Type parameter is set to PTC RTD or NTC RTD. Autorange is not available for the Diode sensor type.

Menu Navigation:

Input Setup→Input (A, B, C, or D)→Autorange→(Off or On)

Input Setup→Input (A, B, C, or D)→Range→(See table below)

Default: On

Interface Command: **INTYPE**

Sensor Type	Available Range Settings	Maximum Sensor Power	Sensor Excitation
Diode	2.5 V (Silicon)	25 μ W (at 10 μ A excitation)	10 μ A, 1 mA
	10 V (GaAlAs)	100 μ W (at 10 μ A excitation)	10 μ A, 1 mA
PTC RTD (Platinum)	10 Ω	10 μ W	1 mA
	30 Ω	30 μ W	
	100 Ω	100 μ W	
	300 Ω	300 μ W	
	1 k Ω	1 mW	
	3 k Ω	3 mW	
	10 k Ω	10 mW	
NTC RTD (Cernox)	10 Ω	10 μ W	1 mA
	30 Ω	2.7 μ W	300 μ A
	100 Ω	1 μ W	100 μ A
	300 Ω	270 nW	30 μ A
	1 k Ω	100 nW	10 μ A
	3 k Ω	27 nW	3 μ A
	10 k Ω	10 nW	1 μ A
	30 k Ω	2.7 nW	300 nA
100 k Ω	1 nW	100 nA	

TABLE 4-8 Range and sensor power

4.4.5 Thermal Electromotive Force (EMF) Compensation

To keep power low and avoid sensor self heating, the sensor excitation is kept low. There are two major problems that occur when measuring the resulting small DC voltages. The first is external noise entering the measurement through the sensor leads, which is discussed with sensor setup. The second is the presence of thermal EMF voltages, or thermocouple voltages, in the lead wiring. Thermal EMF voltages appear when there is a temperature gradient across a piece of voltage lead. Thermal EMF voltages must exist because the sensor is almost never the same temperature as the instrument. To minimize them, use careful wiring, make sure the voltage leads are symmetrical in the type of metal used and how they are joined, and keep unnecessary heat sources away from the leads. Even in a well-designed system thermal EMF voltages can be an appreciable part of a low voltage sensor measurement.

The Model 336 can help with a thermal compensation algorithm. The instrument will automatically reverse the polarity of the current source every other reading. The average of the positive and negative sensor readings will cancel the thermal EMF voltage that is present in the same polarity, regardless of current direction. This correction algorithm is enabled by default for RTD sensor types, but can be turned off using the Current Reversal parameter.

The Current Reversal parameter defaults to On anytime the Sensor Type parameter is changed to PTC RTD or NTC RTD.

Menu Navigation:

Input Setup→Input (A, B, C, or D)→Current Reversal→(Off or On)

Default: On

Interface Command: **INTYPE**

4.4.6 Thermocouple Sensor Input Setup (Model 3060 Only)

When a Model 3060 Thermocouple option is installed in the Model 336, a setting of Thermocouple becomes available under the Sensor Type parameter in the Input Setup menu. The standard diode/RTD sensor inputs can still be used when the Thermocouple option is installed, but the Thermocouple and standard inputs cannot be used simultaneously. Refer to section 7.6.1 to install the Model 3060.

Thermocouples include a variety of commercial (such as E, K, T) and specialty types such as cryogenic (Chromel–AuFe). Standard curves are included in the Model 336 for the types listed in TABLE 4-7. Other types can be used as long as an appropriate temperature response curve is loaded as a user curve. Representative thermocouple specifications are given in TABLE 1-2. The Model 336 provides one thermocouple range and no excitation because thermocouples do not require it. Internal room temperature compensation is included for convenience (section 4.4.6.2) and should be calibrated before use. Room temperature compensation is enabled by default, but can be turned off if external compensation is being used.

Menu Navigation:

Input Setup→Input (C or D)→Sensor Type→Thermocouple

Interface Command: **INTYPE**

4.4.6.1 Internal Room Temperature Compensation

Room-temperature compensation is required to give accurate temperature measurements with thermocouple sensors. It corrects for the temperature difference between the instrument thermal block and the curve normalization temperature of 0 °C. An external ice bath is the most accurate form of compensation, but is often inconvenient. The Model 336 has internal room-temperature compensation that is adequate for most applications. You can turn internal compensation on or off. It operates with any thermocouple type that has an appropriate temperature response curve loaded. Room-temperature compensation is not meaningful for sensor units measurements.



Room temperature compensation should be calibrated as part of every installation (section 4.4.6.2)

Menu Navigation:

Input Setup→Input (C or D)→Room Compensation→(Off or On)

Default: On

Interface Command: **INTYPE**

4.4.6.2 Internal Room Temperature Compensation Calibration Procedure

Factory calibration of the instrument is accurate to within approximately ± 1 K. Differences in thermocouple wire and installation technique create errors greater than the instrument errors. To achieve the best accuracy, calibrate with the thermocouple actually being used, because it eliminates most sources of error. If that is not possible, use a thermocouple made from the same wire.



It is best practice to use the same material for thermocouple wires; if it is at all possible, it is also best to avoid splices. When splices are necessary, continue the splice with the same type of material.

For less demanding applications, a short across the input terminals will suffice. Both thermocouple inputs should be calibrated, even if they use the same type of thermocouple. An appropriate curve must be selected and room temperature compensation must be turned on before calibration can be started.

Follow this procedure to calibrate room temperature compensation:



For best results, the calibration temperature should be close to the measurement temperature that requires best accuracy.

1. Attach a thermocouple sensor or direct short across the input terminals of the thermocouple input. See FIGURE 3-8 for polarity.
2. Place the instrument away from drafts. If calibrating using a short, place an accurate room-temperature thermometer near the terminal block.
3. Allow the instrument to warm up for at least 1/2 hr without moving or handling the sensor.
4. If calibrating with a short, skip to step 6, otherwise insert the thermocouple into the ice-bath, liquid nitrogen, helium Dewar, or other known, fixed temperature.
5. Read the displayed temperature. If the temperature display is not as expected, check to be sure that the thermocouple is making good thermal contact. If possible, add a thermal mass to the end of the thermocouple.
6. Press **Input Setup** and select the corresponding sensor input. Scroll down to the Room Calibration parameter and press **Enter**.
7. The current temperature reading is displayed in kelvin. Press **Enter** to enter Number Entry mode. Enter the true temperature that the thermocouple should read. If input is shorted, then enter the actual room temperature measured by the thermometer. Press **Enter** to save the value.
8. To verify calibration, check that the temperature reading for the calibrated input matches the room temperature calibration setting value.

Any previous calibration can be cleared using the Clear Calibration submenu.

Menu Navigation:

Input Setup→*Room Calibration*→*Clear Calibration*

Default: Room calibration cleared

4.4.7 Capacitance Sensor Input Setup (Model 3061 Only)

When a Model 3061 capacitance option is installed in the Model 336, a setting of Capacitance becomes available under the Sensor Type parameter in the Input Setup menu. The standard sensor inputs can still be used when the capacitance option is installed, but the capacitance and standard inputs cannot be used simultaneously. Refer to section 7.6.1 to install the Model 3061.

Capacitive sensors in the Model 336 do not support temperature conversion; therefore temperature response curves cannot be selected. Any feature of the Model 336 that requires temperature to operate is not supported with the option card. Refer to section 3.6 for more information on using the Model 3061.

4.4.7.1 Range Selection

The capacitance option input has two input voltage ranges, 15 nF and 150 nF. The lower range is specified to 15 nF, but can read up to 25 nF, and is recommended for CS-401 series sensors. The higher range is specified to 150 nF, but can read up to 250 nF, and is recommended for CS-510 series sensors.

Menu Navigation:

Input Setup→*Input (D)*→*Sensor Type*→Capacitance

Interface Command: **INTYPE**

4.4.7.2 Temperature Coefficient Selection

Capacitance sensors can have both a positive and negative temperature coefficient (slope). They have a positive temperature coefficient at very low temperatures and a negative temperature coefficient at warmer temperature. Sensor data sheets detail where the coefficient changes. There is often a temperature range where the sensor is not usable. Temperature control is impossible if the Model 336 does not know which slope the sensor is on. System overheating can result if the wrong coefficient is chosen. The user must select a temperature coefficient before control is switched to the capacitance input.

Menu Navigation:

Input Setup → *Input (D)* → *Temp Coefficient* → (Negative or Positive)

Interface Command: **INTYPE**

4.4.7.3 Control Channel Changes

The capacitance input continues control at a stable temperature established with another sensor. Allow the temperature to stabilize for one hour after large temperature changes to allow capacitance sensor recovery.

When the control channel is changed to the capacitance input, the Model 336 automatically changes the control setpoint to the present capacitance reading. It is not necessary for the user to write down the capacitance value and enter a new setpoint. Control parameters, P and I, may need to be changed for stable control.

4.4.8 4-Channel Scanner Input Setup (Model 3062 Only)

When a Model 3062 4-Channel Scanner option is installed in the Model 336, 4 additional channels, D2, D3, D4, and D5, become available for use. The channels are scanned with the Model 336's Input D at a reduced update rate. The scanner option channels can be configured for diode, negative temperature coefficient resistor, or positive temperature coefficient resistor sensors. Specifications for the 4-channel scanner option are given in TABLE 4-9.

Menu Navigation:

Input Setup → *Input (D2, D3, D4, or D5)* → *Sensor Type* → (Disabled, Diode, PTC RTD (Platinum), NTC RTD (Cernox))

Default: Diode

Interface Command: **INTYPE**

4.4.8.1 Type and Range Selection

The 4-channel scanner option can be configured as either diode, PTC RTD, or NTC RTD. Autorange will be on by default whenever the Sensor Type parameter is set to PTC RTD or NTC RTD. To manually select the resistance range, set the Autorange parameter to **Off**, then use the Range parameter to select the desired range.

Menu Navigation:

Input Setup → *Input (D2, D3, D4, or D5)* → *Autorange* → (Off or On)

Input Setup → *Input (D2, D3, D4, or D5)* → *Range* → (See TABLE 4-9)

Default: On

Interface Command: **INTYPE**

Sensor Type	Available Range Settings	Maximum Sensor Power	Sensor Excitation
Diode	2.5 V (Silicon)	25 μ W (at 10 μ A excitation)	10 μ A, 1mA
	10 V (GaAlAs)	100 μ W (at 10 μ excitation)	10 μ A, 1mA
PTC RTD (Platinum)	10 Ω	10 μ W	1 mA
	30 Ω	30 μ W	
	100 Ω	100 μ W	
	300 Ω	300 μ W	
	1 k Ω	1 mW	
	3 k Ω	3 mW	
	10 k Ω	10 mW	
NTC RTD (Cernox)	10 Ω	10 μ W	1 mA
	30 Ω	2.7 μ W	300 μ A
	100 Ω	1 μ W	100 μ A
	300 Ω	270 nW	30 μ A
	1 k Ω	100 nW	10 μ A
	3 k Ω	27 nW	3 μ A
	10 k Ω	10 nW	1 μ A
	30 k Ω	2.7 nW	300 nA
	100 k Ω	1 nW	100 nA

TABLE 4-9 Model 3062 4-channel scanner option range and sensor power

4.4.8.2 Update Rate

The update rate for the scanned input channels is dependent on the number of channels enabled and how many enabled channels are configured for 100 k Ω NTC RTD. The scanned input channels are scanned at a rate of 10 rdg/s (100 ms/rdg), with the exception of any channel that is configured for 100 k Ω NTC RTD. Channels configured for 100 k Ω NTC RTD are scanned at a rate of 5 rdg/s (200 ms/rdg) when other channels are enabled, or if it is reversing. See TABLE 4-10.

Number of scanner channels enabled	Update rate
1	10 rdg/s (100 ms/rdg)
2	5 rdg/s (200 ms/rdg)
3	3 $\frac{1}{3}$ rdg/s (300 ms/rdg)
4	2 $\frac{1}{2}$ rdg/s (400 ms/rdg)
5	2 rdg/s (500 ms/rdg)

TABLE 4-10 Model 3062 4-channel scanner option reading update rate



System control performance may be affected by a decreased update rate. Filtering is affected by a decreased update rate. Refer to section 4.4.10 for more information

4.4.9 Curve Selection

The Model 336 supports a variety of temperature sensors manufactured by Lake Shore and other manufacturers. After the appropriate sensor type is selected (section 2.2), an appropriate curve may be selected. The Model 336 can use curves from several sources. Standard curves are preloaded with every instrument and numbered 1 to 20. User curves, numbered 21 to 59, can be used when a sensor does not match a standard curve. SoftCal™ calibrations are stored as user curves, or you can enter your own curves from the front panel (section 5.8) or computer interface (section 6.4). The complete list of sensor curves preloaded in the Model 336 is provided in TABLE 4-11.

During normal operation, only the curves that share the input type you have selected are displayed. If the curve you wish to select does not appear in the selection sequence make sure the curve format matches the recommended format for the input type selected. Refer to TABLE 4-7.



The sensor reading of the instrument can always be displayed in sensor units. If a temperature response curve is selected for an input, its readings may also be displayed in temperature.

Curve Number	Curve Name	Sensor Type	Model Number	Temperature Range**	For Data Points, Refer To:
01	DT-470	Diode	DT-470	1.4 - 475 K	Table D-1
02	DT-670	Diode	DT-670	1.4 - 500 K	Table D-2
03	DT-500-D*	Diode	DT-500-D	1.4 - 365 K	Table D-3
04	DT-500-E1*	Diode	DT-500-E1	1.1 - 330 K	Table D-3
05	Reserved	—	—	—	—
06	PT-100	PTC RTD	PT-100	30 - 800 K	Table D-4
07	PT-1000*	PTC RTD	PT-1000	30 - 800 K	Table D-4
08	RX-102A-AA	NTC RTD	Rox RX-102A	0.05 - 40 K	Table D-5
09	RX-202A-AA	NTC RTD	Rox RX-202A	0.05 - 40 K	Table D-6
10	Reserved	—	—	—	—
11	Reserved	—	—	—	—
12	Type K	Thermocouple	Type K	3 - 1645 K	Table D-7
13	Type E	Thermocouple	Type E	3 - 1274 K	Table D-8
14	Type T	Thermocouple	Type T	3 - 670 K	Table D-9
15	AuFe 0.03%*	Thermocouple	AuFe 0.03%*	3.5 - 500 K	Table D-10
16	AuFe 0.07%	Thermocouple	AuFe 0.07%	3.15 - 610 K	Table D-11
17	Reserved	—	—	—	—
18	Reserved	—	—	—	—
19	Reserved	—	—	—	—
20	Reserved	—	—	—	—
21 - 59	User Curves	—	—	—	—

*No longer offered by Lake Shore

**Instrument may not support the sensor over its entire range

TABLE 4-11 Sensor curves

Once the input is configured (section 4.4), you may choose a temperature curve. Any standard or user curve that matches the format of the sensor type configured for a given input will be available under the Curve parameter in the Input Setup menu for that input. You are also given the choice of None. When set to None, front panel readings configured for kelvin or Celsius will display the NOCURV message and the interface will report 0 K and $-273.15\text{ }^{\circ}\text{C}$ for KRDG and CRDG queries, respectively. Data points for standard curves are detailed in Appendix C.

Menu Navigation:

Input Setup → Input (A, B, C or D) → Curve → (Any curve of matching type)

4.4.10 Filter

The reading filter applies exponential smoothing to the sensor input readings. If the filter is turned on for a sensor input, all reading values for that input are filtered. The filter is a running average so it does not change the update rate of an input. Filtered readings are not used for control functions but they are used for all input features including Max/Min.

The number of filter points determines filter bandwidth. One filter point corresponds to one new reading on that input. A larger number of points does more smoothing, but also slows the instruments response to real changes in temperature. The default number of filter points is 8, which settles to within six time constants of a step change value in 45 readings, or 4.5 s.

The time constant (time it takes to settle to within 36.8% of the step value after a step change) for a given number of filter points can be derived using the following formula: $TC = 0.1 / (\ln(N / (N - 1)))$, where TC is one time constant, and N is the number of filter points. A reading is usually considered settled after six time constants. TABLE 4-12 shows a sampling of filter settings and the resulting time constant, settle time, and equivalent noise bandwidth.

Filter points	Time constant	Settle time (6 time constants)	Equivalent noise bandwidth ($\frac{1}{4}$ TC)
2	0.14 s	0.9 s	1.733 Hz
4	0.35 s	2.1 s	0.719 Hz
8	0.75 s	4.5 s	0.334 Hz
16	1.55 s	9.3 s	0.161 Hz
32	3.15 s	18.9 s	0.079 Hz
64	6.35 s	38.1 s	0.039 Hz

TABLE 4-12 Filter settle time and bandwidth

The filter window is a limit for restarting the filter. If a single reading is different from the filter value by more than the limit, the instrument will assume the change was intentional and restart the filter. Filter window is set in percent of full scale range.

When the Model 3062 4-channel scanner option card is installed, the time it takes to get a new reading is increased if more than one scanner channel is enabled or a channel is configured for a range that requires a reduced update rate. This reduction in update rate modifies the time constant of the filter. The time constant of the filter can be derived using the formula $TC = T / (\ln(N / (N - 1)))$, where TC is one time constant, T is the update rate of the channel in seconds per reading, and N is the number of filter points. Refer to section 4.4.8.2 for information on update rates of the Model 3062. TABLE 4-13 shows a sampling of enabled scanner channels with the number of filter points set to 8 and resulting time constant, settle time, and equivalent noise bandwidth.

Scanner channels enabled	Time constant with 8 filter points	Settle time (6 time constants)	Equivalent noise bandwidth ($\frac{1}{4}$ TC)
1	0.75 s	4.5 s	0.334 Hz
2	1.50 s	9 s	0.167 Hz
3	2.25 s	13.5 s	0.111 Hz
4	3.00 s	18.0 s	0.083 Hz
5	3.74 s	22.5 s	0.067 Hz

TABLE 4-13 Example of a filter settle time and bandwidth for a Model 3062 4-channel scanner option card

Menu Navigation:

Input Setup → Input (A, B, C or D) → Filter → (Off or On)

Input Setup → Input (A, B, C or D) → Filter Points → (2 to 64)

Input Setup → Input (A, B, C or D) → Filter Window → (1% to 10%)

Default: Filter → (Off)

Filter Points → 8

Filter Window → 10%

4.4.11 Input Name

To increase usability and reduce confusion, the Model 336 provides a means of assigning a name to each of the four sensor inputs. The designated input name is used on the front panel display whenever possible to indicate which sensor reading is being displayed. It is also used in the output section of the custom display mode to denote which sensor input is associated with the displayed output to form a control loop. Refer to section 4.2.3 for Alpha-Numeric entry.

Menu Navigation:

Input Setup→*Input (A, B, C or D)*→*Input Name*→(15 Character String)

Default: *Input (A, B, C, D)*

Interface Command: **INNAME**

4.4.12 Temperature Limit

The Temperature Limit parameter provides a means of protecting your equipment from damage by shutting down all control outputs when the assigned temperature limit is exceeded on any sensor input. The parameter is available for each of the four sensor inputs. A temperature limit of 0 K (default value) turns this feature off.

Menu Navigation:

Input Setup→*Input (A, B, C or D)*→*Temperature Limit*→(OK to 2999K)

Default: 0.0000 K

Interface Command: **TLIMIT**

4.4.13 Preferred Units

The Preferred Units parameter setting determines which units are used to display setpoint and max/min parameters whenever these parameters are displayed in any display mode. The sensor reading is also displayed in Preferred Units in all display modes except for the Custom display mode, where each sensor location can be assigned specific display units.

Menu Navigation:

Input Setup→*Input (A, B, C or D)*→*Preferred Units*→(K, C, or Sensor)

4.4.14 Max/Min

The Max/Min feature captures and stores the highest (Max) and lowest (Min) reading taken since the last reset. The Preferred Units parameter, under the Input Setup menu, determines the units used for capturing Max and Min.

Max and Min are always being captured, so there is no need to turn the feature on or off. The readings are reset when the instrument is turned off, sensor input parameters are changed, or the Max/Min Reset key is pressed.

Menu Navigation:

Max/Min Reset

4.5 Output and Control Setup

Once the sensor inputs have been configured (section 4.4), the outputs can be configured. The Output Setup menu is used to create control loops for controlling temperature, whether using feedback (closed loop) or manually setting the output (open loop). This section describes how to operate the output and control features, and how to set control parameters. Each control parameter should be considered before turning on a control loop output or the instrument may not be able to perform the most simple control functions. A good starting point is deciding which control loop to use, whether to operate in open or closed control mode and which tuning mode is best for the application. Other parameters fall into place once these have been chosen. Section 2.7 of this manual describes the principals of closed loop proportional, integral, and derivative (PID) control.

4.5.1 Heater Outputs

Heater Outputs 1 and 2 are traditional control loop heater outputs for a cryogenic temperature controller. The two outputs are identical except in the amount of power available. Output 1 can provide up to 100 W, and Output 2 can provide up to 50 W. They each include a large set of hardware and software features making them very flexible and easy to use. The heater outputs are well-regulated DC outputs. This provides quiet, stable control for a broad range of temperature control systems in a fully integrated package. The power ranges for each output provide decade steps in power.

4.5.1.1 Max Current and Heater Resistance

The Model 336 heater outputs are designed to work optimally into a 25 Ω or 50 Ω heater. The Heater Resistance and Max Current parameters work together to limit the maximum available power into the heater. This is useful for preventing heater damage or limiting the maximum heater power into the system. When using a 25 Ω or 50 Ω heater, set the Heater Resistance parameter accordingly. The Max Current setting will then provide multiple discrete current limit values that correspond to common heater power ratings. The available current limits keep the output operating within the voltage compliance limit to ensure the best possible resolution. These parameters work with the Heater Range parameter (section 4.5.1.5.8) to provide safety and flexibility.

If you are not using a standard heater resistance, set the Heater Resistance setting to 25 Ω for any resistance less than 50 Ω , or to 50 Ω for any higher heater resistance. The user max current setting is useful when using a non-standard heater resistance value. Refer to section 4.5.1.1.1 for more information on User Max Current. TABLE 4-14 provides examples of different heater resistances and max current settings, and the resulting maximum heater power. The maximum heater powers in bold represent the discrete current limits available under the Max Current setting for 25 Ω and 50 Ω heaters.

Menu Navigation:

Output Setup → *Output (1 or 2)* → *Heater Resistance* → (25 Ω or 50 Ω)

Output Setup → *Output (1 or 2)* → *Max Current* → (User, 0.707 A, 1 A, 1.414 A, or 2 A)

Default:

Heater Resistance → 25 Ω

Output 1 → *Max Current* → 2 A

Output 2 → *Max Current* → 1.414 A

Interface Command: HTRSET

4.5.1.1.1 User Max Current

When using a heater that is not 25 Ω , 100 W or 50 Ω , 50 W the provided discrete current limits may not be appropriate. The User Max Current setting is available for this case. The optimal maximum current value should be calculated based on the heater's power rating, or the maximum desired heater output power, whichever is lower. The heater output compliance voltage (50 V for both heater outputs) should also be taken into account in order to maximize heater setting resolution. This calculated current limit can then be entered using the User Max Current setting.

To calculate the Max Current setting based on a heater or load power limit, calculate current, I, using both of the following equations: $I = \sqrt{P/R}$ and $I = 50 \text{ V}/R$ where P is the maximum allowable power, R is the heater resistance. The load power limit and voltage compliance limit of the heater output (50 V) are in place at the same time, so the lower calculated current is the correct Max Current setting.

Example 1: A 50 Ω, 30 W heater is connected to Output 1.

Power Limit	Voltage Compliance Limit
$I = \text{Sqrt}(P/R)$	$I = 50 \text{ V}/R$
$I = \text{Sqrt}(30 \text{ W}/50\Omega)$	$I = 50 \text{ V}/ 50 \Omega$
$I = 0.77 \text{ A}$	$I = 1 \text{ A}$

User Max Current should be set to the smaller of the two or 0.77 A. In this example, the desired 30 W of power is available to the heater.

Example 2: A 75 Ω, 50 W heater is connected to Output 1.

Power Limit	Voltage Compliance Limit
$I = \text{Sqrt}(P/R)$	$I = 50 \text{ V}/R$
$I = \text{Sqrt}(50 \text{ W}/75\Omega)$	$I = 50 \text{ V}/ 75 \Omega$
$I = 0.81 \text{ A}$	$I = 0.66 \text{ A}$

User Max Current should be set to the smaller of the two or 0.66 A. In this example, only 33 W of the desired 50 W of power is available to the heater.

To enter a User Max Current, first set the Heater Resistance setting to 25 Ω for any resistance less than 50 Ω, or to 50 Ω for any higher heater resistance. Set the Max Current setting to User. The User Max Current setting now becomes available in the Output Setup menu. Enter the calculated current limit value in the User Max Current parameter.

	Heater Resistance					
Max Current	10 Ω	25 Ω	30 Ω	40 Ω	50 Ω	100 Ω
2 A	40 W	100 W				
1.667 A (User)	28 W	69.5 W	83 W			
1.414 A	20 W	50 W	60 W			
1.25 A (User)	15 W	39 W	46 W	62.5 W		
1 A	10 W	25 W	30 W	40 W	50 W	
0.707 A	5 W	12.5 W	15 W	20 W	25 W	
0.5 A (User)	2.5 W	6 W	7.5 W	10 W	12.5 W	25 W

Shaded black: Max current too high for these resistances due to voltage compliance limit

Lightly shaded: Maximum current/power only available on heater output 1

Bold: Discrete options available for 25 Ω and 50 Ω heaters under the Max Current setting

TABLE 4-14 User Max Current

Menu Navigation:

Output Setup → Output (1 or 2) → User Max Current → (0.1 A to 2 A)

Default:

Output 1 → User Max Current → 2 A

Output 2 → User Max Current → 1.414 A

4.5.1.2 Power Up Enable

All configuration parameters of the Model 336 can be retained through a power cycle. Some systems require that the Heater Range is turned off when power is restored. The power up enable feature allows you to choose whether or not the heater range is turned off each time the instrument power is cycled. Set the Power Up Enable parameter to Off to ensure that the heater range is turned off on power up. Set it to On to return the Heater Range to its previous setting when power is restored.

Menu Navigation:

Output Setup→*Output (1, 2, 3, or 4)*→*Power Up Enable*→(Off or On)

Default: Off

Interface Command: **OUTMODE**

4.5.1.3 Heater Out Display

The heater output can be displayed in units of percent of full scale current or percent of full scale power. The heater output display on the front panel is displayed in these units, and the Manual Output parameter is set in these units. Available full scale current and power are determined by the heater resistance, max current setting, and heater range.



The heater output display is a calculated value intended to aid in system setup and tuning. It is not a measured value, and may not accurately represent actual power in the heater.

Menu Navigation:

Output Setup→*Output (1, 2)*→*Heater Out Display*→(Current or Power)

Default: Current

Interface Command: **HTRSET**

4.5.1.4 Output Modes

The heater outputs can be configured in one of four output modes: Off, Closed Loop PID, Zone, or Open Loop. The Off mode prevents current from being sourced to the given output. Closed Loop PID is the mode most often used for controlling temperature. Zone mode builds on the Closed Loop mode by providing automatic changing of control parameters at up to ten different temperature zones. Open Loop mode provides a means of applying a constant current to the output.

Menu Navigation:

Output Setup→*Output (1 or 2)*→*Output Mode*→(Off, Closed Loop PID, Zone, Open Loop)

Default: Off

Interface Command: **OUTMODE**

4.5.1.4.1 Closed Loop PID Mode

The Closed Loop PID mode is the most commonly used closed loop control mode for tightly controlling temperature using the heater outputs of the Model 336. In this mode the controller attempts to keep the load at exactly the user-entered setpoint temperature. To do this, it uses feedback from the control input sensor to calculate and actively adjust the control output setting. The Model 336 uses a control algorithm called PID that refers to the three terms used to tune the control. Refer to section 4.4.11 for details on assigning a Control Input for the closed loop feedback. Refer to section 2.7 and section 2.8 for a detailed discussion of PID control and manual tuning.

In Closed Loop PID mode, the controller will accept user-entered Proportional, Integral, and Derivative parameters to provide 3-term PID control. Manual output can be used during closed loop control to add to the calculated PID control output.

Menu Navigation:

Output Setup→Output (1 or 2)→Output Mode→Closed Loop PID

4.5.1.4.2 Zone Mode

Optimal control parameter values are often different at different temperatures within a system. Once control parameter values have been chosen for each temperature range (or zone), the instrument will update the control settings each time the setpoint crosses into a new zone.



If desired, the control parameters can be changed manually, just like Closed Loop PID mode, but they will be automatically updated once the setpoint crosses a zone boundary.

The control algorithm used for each zone is identical to that used in Closed Loop PID mode. The Zone feature is useful by itself, but it is even more powerful when used with other features. We recommend using zone mode with setpoint ramping (section 4.5.1.5.7). Refer to section 5.3 for details on setting up zones. Refer to section 2.7 for a detailed discussion of PID control.

Menu Navigation:

Output Setup→Output (1 or 2)→Output Mode→Zone

4.5.1.4.3 Open Loop Mode

Open Loop output mode allows you to directly set the output using only the Manual Output and Range parameters. This guarantees constant current to the load, but it does not actively control temperature. Any change in the characteristics of the load will cause a change in temperature.

You can configure any output to Open Loop mode. When an output is configured in this mode, the Manual Output and Heater Range parameters become available in the Output Setup menu for setting the output. For convenience, the Control Input parameter can be used to assign a sensor input, which then allows the output to be displayed on the front panel when using that sensor input's display mode. When displayed on the front panel, the Manual Output and Heater Range direct operation keys can be used for one touch access to these settings. Refer to section 4.3.1 for details on configuring display modes.



Since there is no sensor feedback in open loop mode, there is nothing to prevent the system from being overheated. We recommend using the Temperature Limit feature to help protect the system from overheating. Refer to section 4.4.12 for temperature limits.

Menu Navigation:

Output Setup→Output (1, 2, 3, or 4)→Output Mode→Open Loop

4.5.1.5 Control Parameters

Once the output mode is chosen, the control parameters can be used to begin controlling temperature. Control Input is used to create a control loop. The P, I, and D parameters provide fine tuning of the control algorithm. Manual Output provides a baseline output power about which to control. Setpoint is used to set the desired target temperature, and Heater Range is used to turn on the control output, as well as to set the power range of the output. These parameters are described in detail in section 4.5.1.5.1 to section 4.5.1.5.8.

4.5.1.5.1 Control Input

For closed loop control (Closed Loop PID, Zone, Warm Up Supply) a control loop must be created. A control loop consists of a control output for controlling the temperature, and an input for feedback into the control algorithm. Use the Control Input parameter to assign the control input sensor to the desired output.

In the Monitor Out mode the Control Input parameter is used to determine the source of the output voltage. In the Open Loop mode, the Control Input parameter can be set simply for convenience in order to easily access the associated output's Manual Output and Heater Range parameters using the Direct Operation keys. Refer to section 4.2.1.1 for details on Direct Operation keys.

Menu Navigation:

Output Setup→*Output* (1, 2, 3, or 4)→*Control Input*→(None, Input A, Input B, Input C, Input D)

Default: *Output 1*→*Control Input*→(Input A)

Output 2→*Control Input*→(Input B)

Output (3, 4)→Off

Interface Command: **HTRSET**

4.5.1.5.2 Proportional (P)

The proportional parameter (also called gain) is the P part of the PID control equation. It has a range of 0 to 1000 with a resolution of 0.1. The default value is 50. Enter a value greater than 0 for P when using closed loop control.

To set P, first configure the front panel display to show the desired control loop information, then use the P key on the front panel. A quick way to access the setting if the control loop information is not already being displayed, is to press A, B, C, or D on the front panel to temporarily display the control loop information while the new setting is entered. Refer to section 4.3 for details on configuring the front panel display.

Menu Navigation:

P→(0 to 1000)

Default: 50

Interface Command: **PID**

4.5.1.5.3 Integral (I)

The integral parameter (also called reset) is the I part of the PID control equation. It has a range of 0 to 1000 with a resolution of 0.1. The default value is 20. Setting I to 0 turns the reset function off. The I setting is related to seconds by:

$$I_{\text{setting}} = 1000 / I_{\text{seconds}}$$

For example, a reset number setting of 20 corresponds to a time constant of 50 s. A system will normally take several time constants to settle into the setpoint. The 50 s time constant, if correct for the system being controlled, would result in a system that stabilizes at a new setpoint in between 5 min and 10 min.

To set I, first configure the front panel display to show the desired control loop information, then use the I key on the front panel. A quick way to access the setting if the control loop information is not already being displayed is to press A, B, C, or D on the front panel to temporarily display the control loop information while the new setting is entered. Refer to section 4.3 for details on configuring the front panel display.

Menu Navigation:

I→(0 to 1000)

Default: 20

Interface Command: **PID**

4.5.1.5.4 Derivative (D)

The derivative parameter (sometimes called rate) is the D part of the PID control equation. The derivative time constant should normally be somewhere between $\frac{1}{4}$ and $\frac{1}{8}$ the integral time in seconds, if used at all. As a convenience to the operator, the Model 336 derivative time constant is expressed in percent of $\frac{1}{4}$ the integral time. The range is between 0% and 200%. Start with settings of 0%, 50%, or 100%, and determine which setting gives you the type of control you desire. Do not be surprised if the setting you prefer is 0%. Note that by using a percent of integral time, derivative scales automatically with changes in the integral value and does not have to be revisited frequently.

To set D, first configure the front panel display to show the desired control loop information, then use the **D** key on the front panel. A quick way to access the setting if the control loop information is not already being displayed is to press **A**, **B**, **C**, or **D** on the front panel to temporarily display the control loop information while the new setting is entered. Refer to the section 4.3 for details on configuring the front panel display.

Menu Navigation:

D→(0% to 200%)

Default: 0%

Interface Command: **PID**

4.5.1.5.5 Manual Output

Manual Output is a manual setting of the control output. It can function in two different ways depending on control mode. In open loop control mode, the Manual Output is the only output to the load. You can directly set the control output from the front panel or over the computer interface. In closed loop control mode, Manual Output is added directly to the output of the PID control equation. In effect, the control equation operates about the Manual Output setting.

The Manual Output setting is in percent of full scale. Percent of full scale is defined as percent of full-scale current or power on the selected heater range. Refer to section 4.5.1.3 to set the Heater Out display. Available full scale current and power are determined by the heater resistance, Max Current setting, and Heater Range. Manual Output setting range is 0% to 100% with a resolution of 0.01%.

To set Manual Output, first configure the front panel display to show the desired control loop information, and then press **Manual Output** on the front panel. A quick way to access the setting if the control loop information is not already being displayed is to press **A**, **B**, **C**, or **D** on the front panel to temporarily display the control loop information while the new setting is entered. Refer to section 4.3 for details on configuring the front panel display.

When an output is configured for Open Loop mode, the Manual Output setting is available in the Output Setup menu. This is because in the Open Loop mode no Control Input (feedback sensor) is required, and if none is set then there would be no way to use the **Manual Output** front panel key to set the output unless using the Custom Display mode. The Control Input parameter can be assigned to a sensor input (that is not being used for control) as a means of quickly accessing the Manual Output setting using the **Manual Output** front panel key.

Menu Navigation:

Manual Output→(0% to 100%)

Default: 0%

Interface Command: **MOU**

4.5.1.5.6 Setpoint

Use the Setpoint parameter to set the desired load temperature for a control loop. Before entering a setpoint, a control loop must be created by configuring an input sensor and assigning it to a control output using the Control Input parameter. The Setpoint can be entered in either temperature units or sensor units, based on the sensor input's Preferred Units setting. The Setpoint Ramping feature is available when controlling in temperature units to provide smooth, continuous control from one temperature to the next. Refer to section 4.4 for details on Input Setup. Refer to section 4.5.1.5.1 for details on assigning a Control Input. Refer to section 4.5.1.5.7 for details on the Setpoint Ramping feature.

Most applications require control in units of temperature. To control in units of temperature, set the Preferred Units parameter of the control input sensor to either kelvin or Celsius. When controlling in temperature, the available setting range of the setpoint is limited by the Setpoint Limit parameter of the assigned temperature curve. Refer to section 4.4.13 for details on setting the Preferred Units parameter. Refer to section 5.8.1 for details on setting a curve Setpoint Limit.



The Setpoint Limit feature only limits the Setpoint entry. For even greater protection, the Temperature Limit feature can be used to turn off all heater outputs if a sensor reading above the specified temperature is observed. Refer to section 4.4.12 for details on the Temperature Limit feature.

There are some instances when temperature control in sensor units may be desired, for example when a temperature curve is not available. For these applications the Model 336 can control temperature in sensor units. To control in sensor units, set the Preferred Units parameter to Sensor. When controlling in sensor units, the Setpoint resolution matches the display resolution for the sensor input type given in the specifications (section 1.3).



Temperature control in sensor units can be unpredictable since most sensors do not have a linear response to temperature, and therefore have can have different sensitivity in different temperature ranges.

If you change the Preferred Units from Sensor to temperature (Kelvin or Celsius), or from temperature to Sensor, the Model 336 uses the assigned temperature curve to convert the Setpoint to the new control units. This provides minimal disruption in the control output if you change the Preferred Units parameter while the control loop is active.

Menu Navigation:
Setpoint→(See note below)

Default: 0.0000 K
Interface Command: **SETP**



When controlling in temperature, setpoint is limited by the control input temperature curve's Setpoint Limit. When controlling in sensor units, setpoint is limited by the limits of the configured control sensor.

4.5.1.5.7 Setpoint Ramping

The Model 336 can generate a smooth setpoint ramp when the setpoint units are expressed in temperature. You can set a ramp rate in degrees per minute with a range of 0 to 100 and a resolution of 0.1. Once the ramping feature is turned on, its action is initiated by a setpoint change. When you enter a new setpoint the instrument changes the setpoint temperature from the old value to the new value at the ramp rate. A positive ramp rate is always entered; it is used by the instrument to ramp either up or down in temperature.

Always use the ramping feature to minimize temperature overshoot and undershoot. When ramping is not used, a setpoint change can cause the error used by the PID equation to become very large, which causes the I contribution of the control output equation to become larger the longer the error exists. This will result in a large overshoot or undershoot once the setpoint temperature is reached, since the I contribution will only decrease when the error polarity is reversed. Use a ramp rate that keeps the control output from reaching the extremes of 100% or 0% while ramping for optimal results.

The ramping feature is useful by itself, but it is even more powerful when used with other features. Setpoint ramps are often used with zone control mode. As temperature is ramped through different temperature zones, control parameters are automatically selected for best control. Ramps can be initiated and status read back using a computer interface. During computer-controlled experiments, the instrument generates the setpoint ramp while the computer is busy taking necessary data.



When an incomplete ramp is shut off, the setpoint will remain on the most current setting (the reading will not jump to the end of the ramp).



If the input type or input curve is changed while a ramp is in progress, both ramping and the heater are turned off.



If Ramp is on and the setpoint is set to sensor units, the ramping function will remain on but when another setpoint is entered, the setpoint goes directly to the new setpoint value.



To bypass ramping and load the setpoint with the current temperature, with the control loop displayed, press and hold the Setpoint button for 3 s.

Menu Navigation:

Output Setup → Output (1 or 2) → Setpoint Ramping → (Off or On)

Default: Off

Interface Command: **RAMP**

To stop a ramp, when the desired control loop is displayed, press **Setpoint**, then immediately press **Enter**. This stops the ramp at the current setpoint, but leaves the ramping function activated. To continue the ramp, enter a new setpoint. Refer to section 4.5.1.5.6 for details on setting the Setpoint parameter.

4.5.1.5.8 Heater Range

The Heater Range setting is used for turning a control output on, as well as setting the output power range for the heater outputs. All four outputs provide an Off setting for turning the output off. The heater outputs, 1 and 2, provide Low, Medium (Med), and High settings which provide decade steps in power, based on the maximum output power available to the connected heater. The High range provides the maximum power, the Med range provides (maximum power)/10 and the Low range provides (maximum power)/100. Refer to section 2.5.1 for details on how to calculate the maximum output power. The unpowered analog outputs, 3 and 4, do not have multiple output ranges, and only provide an On setting for enabling the output.



While controlling temperature, the following will cause the heater range to automatically turn off:

- Exceeding the Temperature Limit setting
- Setup changes to the control input
- Power loss with Power Up Enable feature turned off
- Input errors such as T. Over, T. Under, S. Over, and S. Under



Available full scale current and power are determined by the heater resistance, Max Current setting, and Heater Range.

Specifications of the heater outputs are provided in section 1.3. Heater theory of operation is provided in section 2.5. Various heater installation considerations are provided in section 3.8.

To set Heater Range, first configure the front panel display to show the desired control loop information, then use the **Heater Range** key on the front panel. A quick way to access the setting if the control loop information is not already being displayed is to press **A**, **B**, **C**, or **D** on the front panel to temporarily display the control loop information while the new setting is entered. Refer to section 4.2 for details on configuring the front panel display.

Menu Navigation:

Heater Range → (Off, On, Low, Med, High)

Default: Off

Interface Command: **RANGE**

4.5.1.5.9 ALL OFF

The **ALL OFF** key is provided as a means of shutting down all control outputs with one key. It is equivalent to setting the Heater Range parameter of all outputs to Off.



This function is always active even if the keypad is locked or when it is in remote mode.

4.5.2 Unpowered Analog Outputs

The unpowered analog outputs, 3 and 4, are variable DC voltage sources that can have a range from -10 V to $+10\text{ V}$. The voltage is generated by a 16-bit D/A converter with resolution of 0.3 mV or 0.003% of full scale. These outputs can be configured to Open Loop, Warm Up Supply, or Monitor Out modes. The Open Loop mode can be used to set the output to a specific, constant value. Refer to section 4.5.1.4.3 for details on the Open Loop Mode. The Warm Up Supply mode uses the output to drive the programming input for an external power supply for the purpose of rapidly warming a system to a user-specified temperature. The Monitor Out mode uses the output to provide a voltage proportional to an input sensor reading to be used by an external device such as a data logger.



The unpowered analog outputs are not designed to provide heater power, and although they are short-protected, should not be used to drive a resistance lower than 1 k Ω .

4.5.2.1 Warm Up Supply

Warm Up Supply mode is designed for controlling an external power supply used for rapidly increasing the temperature in the controlled system, for example, to bring a system to room temperature in order to change samples. Refer to section 5.5 for more information on warm up supply operation. Refer to section 3.8.5 for the procedure to install an external power supply for warm up supply mode.

4.5.2.2 Monitor Out

Refer to section 5.6 for more information on Monitor Out mode.

4.6 Interface

The Model 336 has three computer interfaces: IEEE-488, USB, and Ethernet. Only one of these interfaces can be activated at one time. Use the Interface menu to configure which interface is active, and to configure the parameters related to the selected interface.

Menu Navigation:

Interface \rightarrow Enabled \rightarrow (USB, Ethernet, IEEE-488)

Default: USB

4.6.1 USB

The USB interface is provided as a convenient way to connect to most modern computers, as a USB interface is provided on nearly all new PCs as of the writing of this manual. The Model 336 USB driver, which must be installed before using the interface (section 6.3.3), creates a virtual serial com port, which can be used in the same way as a traditional serial com port. Refer to Chapter 6 for details on computer interface operation.

Menu Navigation:

Interface \rightarrow Enabled \rightarrow USB

4.6.2 Ethernet

The Ethernet interface is provided to allow the Model 336 to connect to a computer network. A direct connection to a PC can also be achieved using a cross-over Ethernet cable. The advantages of using the Ethernet interface include the ability to communicate directly with the Model 336 from any PC on the same local network, and even from around the world via the internet. Refer to section 6.4.1 for details on Ethernet configuration.

Menu Navigation:
Interface→Enabled→Ethernet

4.6.3 IEEE-488

An IEEE 488 (GPIB) interface is provided for compatibility with legacy systems. Refer to Chapter 6 for details on computer interface operation.

Menu Navigation:
Interface→Enabled→IEEE-488

4.6.3.1 Remote/Local

Local refers to operating the Model 336 from the front panel. Remote refers to operating the controller via the IEEE 488 Interface. The keypad is disabled during remote operation, except for the **Remote/Local** key and the **All Off** key. When in remote mode, the Remote front panel LED will be illuminated. When in local mode, the Remote LED will not be illuminated.

Menu Navigation:
Remote/Local (LED On = Remote mode, LED Off = Local mode)

4.7 Locking and Unlocking the Keypad

The keypad lock feature prevents accidental changes to parameter values. When the keypad is locked, some parameter values may be viewed, but most cannot be changed from the front panel. All Off is the only keypad function that remains active when the keypad is locked.

A three-digit keypad lock code locks and unlocks the keypad. The factory default code is 123. The code can be changed only through the computer interface. If instrument parameters are reset to default values, the lock code resets also. The instrument cannot reset from the front panel with the keypad locked.

To lock the keypad, press and hold **Enter** for 5 s. Use the numeric keypad to enter the three-digit lock code. If the lock code is accepted, ***** Keypad Locked ***** will be displayed for 3 s, and the display will return to normal. Changes attempted to any parameters result in a brief display of the ***** Keypad Locked ***** message.

To unlock the keypad, press and hold **Enter** for 5 s. Use the numeric keypad to enter the three-digit lock code. If the lock code is accepted, ***** Keypad Unlocked ***** will be displayed for 3 s and the display will return to normal. All Model 336 parameters are now accessible.

Chapter 5: Advanced Operation

5.1 General

This chapter provides information on the advanced operation of the Model 336 temperature controller.

5.2 Autotune

The Model 336 can automate the tuning process of typical cryogenic systems with the Autotune feature. For additional information about the algorithm refer to section 2.9.

Before initiating the Autotune process, properly configure the cooling system with control input sensor and heater output to make it capable of closed-loop control. Assign the control sensor with a valid temperature response curve. Also determine an appropriate heater range as described in section 2.8.1. The system must be coarsely maintaining temperature within 5 K of the setpoint where new tuning parameters are desired in order for the Autotuning process to initiate. Autotune works only with one control loop at a time and does not set the manual output or heater range. For autotuning to work properly on a control loop with a scanner input assigned (Model 3062 4-channel scanner option), only that scanner input channel can be enabled; all other scanner input channels must be disabled.

To initiate the Autotune process, press **Autotune**, then select an Autotune mode. There are three Autotune modes available. They result in slightly different system characteristics. Autotune PI is recommended for most applications.

- **Autotune P:** sets only the P parameter value. I and D are set to 0 no matter what the initial values are. This mode is recommended for systems that have very long lag times or nonlinearity that prevents stable PI control. Expect some overshoot or undershoot of the setpoint and stable temperature control below the setpoint value.
- **Autotune PI:** sets values for both P and I parameters. D is set to 0. This mode is recommended for stable control at a constant temperature. It may take slightly longer to stabilize after setpoint change than Auto PID. Expect some overshoot or undershoot of the setpoint and stable temperature control at the setpoint value.
- **Autotune PID:** sets values for P, I and D parameters. D is always set to 100%. This mode is recommended when setpoint changes are frequent, but temperature is allowed to stabilize between changes. Stability at setpoint may be worse than Autotune PI in noisy systems. Expect slightly less overshoot or undershoot than the other modes and control at the setpoint value.

When the Autotune process is initiated, the P, I, D, and Manual Output parameters are removed from the display and the “Autotuning” message appears in the lower right corner. Below the Autotuning message, the current status of the process is displayed. The status message blinks to indicate that the algorithm is still processing. If an error occurs, the status message stops blinking and displays an error message containing the stage in which Autotune failed. See TABLE 5-1 for a description of the Autotune stages, reasons for failure, and possible solutions. When the process completes successfully, the previous P, I, and D parameters are replaced by the newly acquired values. To cancel the Autotune process, press **Autotune**, and choose Yes to the “cancel Autotune” prompt.

Stage	Description	Purpose for Stage	Reason for Failure	Possible Solution
0	Testing initial conditions	Determine if Autotuning can be initiated	Curve not assigned to Input, heater not on, or temperature not within 5 K of setpoint	Ensure curve is assigned to input, heater is on, and temperature is within 5 K of setpoint
1	Waiting for temperature to settle	Ensures that temperature is not still settling toward the setpoint, or drifting away from the setpoint	Temperature was moving too much to properly Autotune	Allow the temperature to settle more before initiating Autotune
2	Testing for temperature stability	Ensures that there is no temperature oscillation, or excessive noise in the temperature reading	May indicate that the initial P value is too high	Use a smaller initial P value
3	Observing system response to setpoint change	Control parameters are changed based on observation	System response is too slow, or the heater is too underpowered for the system to Autotune	If not already using High range, increase initial heater range
4	Waiting for temperature to settle after returning setpoint to original value	Provides a baseline for subsequent stages	System response is too slow to Autotune, or the new control parameters are causing instability in the control	Use a smaller initial P value
5	Testing for temperature stability	Ensures that there is no temperature oscillation or excessive noise in the temperature reading after control parameter adjustment	System response is too slow to Autotune, or the new control parameters are causing instability in the control	Use a smaller initial P value
6	Observing system response to setpoint change using new control parameters	Control parameters are changed again based on observation. This is the final stage of P only Autotuning	System response is too slow to Autotune, or the heater is too underpowered for the system to Autotune	If not already using High range, increase initial heater range
7	Waiting for temperature to settle after returning setpoint to original value	Provides a baseline for subsequent stages	System response is too slow to Autotune, or the new control parameters are causing instability in the control	Use a smaller initial P value
8	Testing for temperature stability	Ensures that there is no temperature oscillation, or excessive noise in the temperature reading after control parameter adjustment	System response is too slow to Autotune, or the new control parameters are causing instability in the control	Use a smaller initial P value
9	First of 2 stages of observing system response to setpoint change using new control parameters	Compiles data for characterizing the system	Will not fail in this stage	Not applicable
10	Second of 2 stages of observing system response to setpoint change using new control parameters	Control parameters are changed again based on observation. This is the final stage of PI and PID Autotuning	System response is too slow, or the heater is too underpowered for the system to Autotune	If not already using High range, increase initial heater range

TABLE 5-1 Autotune stages

Menu Navigation:

Autotune→Input (A, B, C, D)→(Autotune P, Autotune PI, Autotune PID)

5.3 Zone Settings

The Model 336 allows you to establish up to ten custom contiguous temperature zones where the controller will automatically use pre-programmed values for PID, heater range, manual output, ramp rate, and control input. Zone control can be active for both control loops at the same time. Configure the zones using 1 as the lowest to 10 as the highest zone. Zone boundaries are always specified in kelvin (K). The bottom of the first zone is always 0 K; therefore, only the upper limit is required for all subsequent zones. Make a copy of FIGURE 5-1 to plan your zones.

To use the programmed zones, the output mode must be set to Zone (refer to section 4.5.1.4.2 to set up Zone mode). In Zone mode, the instrument will update the control settings each time the setpoint crosses into a new zone. If you change the settings manually, the controller will use the new setting while it is in the same zone, and will update to the programmed zone table settings when the setpoint crosses into a new zone.

The zone settings include a Control Input parameter for each temperature zone. This allows a different feedback sensor to be used for each temperature zone. For example, a diode sensor can be used while cooling down from room temperature to 10 K, at which point the Control Input could be switched to a Cernox™ sensor for temperatures under 10 K.

To illustrate how the control parameters are updated in Zone mode, consider the zone settings from the table below. Starting from room temperature (about 300 K), and setting a setpoint of 2 K (with Setpoint Ramping turned On), the setpoint will begin ramping at the current setpoint Ramp Rate, then once the setpoint crosses 100 K, the control parameters from Zone 8 will be used. The setpoint ramp will then continue toward 2 K at a rate of 20 K/min until crossing 50 K, when the control parameters from Zone 7 are loaded. This pattern will continue until the final setpoint value of 2 K is reached, or another setpoint is entered. Note that Input B will be used in all zones greater than 10 K (zones 4 to 8), and Input A will be used in all zones below 10 K (zones 1-3).

Zone	Lower Boundary (Implied)	Upper Boundary	P	I	D	Manual Output	Range	Ramp Rate	Control Input
10	n/a	0 K	50	20	0	0.0%	Off	0.1 K/Min	Default
9	n/a	0 K	50	20	0	0.0%	Off	0.1 K/Min	Default
8	100.001 K	500 K	200	20	0	0.0%	High	30 K/Min	Input B
7	50.001 K	100 K	185	25	0	0.0%	Med	20 K/Min	Input B
6	25.001 K	50 K	150	30	0	0.0%	Med	10 K/Min	Input B
5	15.001 K	25 K	100	30	0	0.0%	Med	5 K/Min	Input B
4	10.001 K	15 K	85	35	0	0.0%	Med	2 K/Min	Input B
3	7.001K	10 K	85	35	0	0.0%	Med	0.9 K/Min	Input A
2	4.001 K	7 K	70.0	40.0	0	0.0%	Low	0.7 K/Min	Input A
1	0 K	4 K	50.0	50.0	0	0.0%	Low	0.5 K/Min	Input A

TABLE 5-2 Zone settings example



Sensor accuracy and placement will affect how smoothly the transition from one feedback sensor to another is performed. A large difference between the temperature readings of each sensor at the time of transition could cause a temporary instability in the temperature control due to the sudden large error introduced into the control equation.



It is highly recommended to use the Setpoint Ramping feature when using the Control Input zone parameter to change sensor inputs. Otherwise a setpoint change may cause a control input sensor to be used outside of its usable range, which will cause an overload condition to shut down the control loop.

↑ Zone 10 ↓	Proportional (0.1–1000)	Integral (0.1–1000)	Derivative (0–200)	MHP Output (0–100%)	Heater Range <input type="checkbox"/> Off <input type="checkbox"/> Med <input type="checkbox"/> Low <input type="checkbox"/> High	Upper boundary: K	Ramp Rate (0.1–100 K/min)	Control Input <input type="checkbox"/> Default <input type="checkbox"/> A <input type="checkbox"/> B <input type="checkbox"/> C <input type="checkbox"/> D
↑ Zone 09 ↓	Proportional (0.1–1000)	Integral (0.1–1000)	Derivative (0–200)	MHP Output (0–100%)	Heater Range <input type="checkbox"/> Off <input type="checkbox"/> Med <input type="checkbox"/> Low <input type="checkbox"/> High	Upper boundary: K	Ramp Rate (0.1–100 K/min)	Control Input <input type="checkbox"/> Default <input type="checkbox"/> A <input type="checkbox"/> B <input type="checkbox"/> C <input type="checkbox"/> D
↑ Zone 08 ↓	Proportional (0.1–1000)	Integral (0.1–1000)	Derivative (0–200)	MHP Output (0–100%)	Heater Range <input type="checkbox"/> Off <input type="checkbox"/> Med <input type="checkbox"/> Low <input type="checkbox"/> High	Upper boundary: K	Ramp Rate (0.1–100 K/min)	Control Input <input type="checkbox"/> Default <input type="checkbox"/> A <input type="checkbox"/> B <input type="checkbox"/> C <input type="checkbox"/> D
↑ Zone 07 ↓	Proportional (0.1–1000)	Integral (0.1–1000)	Derivative (0–200)	MHP Output (0–100%)	Heater Range <input type="checkbox"/> Off <input type="checkbox"/> Med <input type="checkbox"/> Low <input type="checkbox"/> High	Upper boundary: K	Ramp Rate (0.1–100 K/min)	Control Input <input type="checkbox"/> Default <input type="checkbox"/> A <input type="checkbox"/> B <input type="checkbox"/> C <input type="checkbox"/> D
↑ Zone 06 ↓	Proportional (0.1–1000)	Integral (0.1–1000)	Derivative (0–200)	MHP Output (0–100%)	Heater Range <input type="checkbox"/> Off <input type="checkbox"/> Med <input type="checkbox"/> Low <input type="checkbox"/> High	Upper boundary: K	Ramp Rate (0.1–100 K/min)	Control Input <input type="checkbox"/> Default <input type="checkbox"/> A <input type="checkbox"/> B <input type="checkbox"/> C <input type="checkbox"/> D
↑ Zone 05 ↓	Proportional (0.1–1000)	Integral (0.1–1000)	Derivative (0–200)	MHP Output (0–100%)	Heater Range <input type="checkbox"/> Off <input type="checkbox"/> Med <input type="checkbox"/> Low <input type="checkbox"/> High	Upper boundary: K	Ramp Rate (0.1–100 K/min)	Control Input <input type="checkbox"/> Default <input type="checkbox"/> A <input type="checkbox"/> B <input type="checkbox"/> C <input type="checkbox"/> D
↑ Zone 04 ↓	Proportional (0.1–1000)	Integral (0.1–1000)	Derivative (0–200)	MHP Output (0–100%)	Heater Range <input type="checkbox"/> Off <input type="checkbox"/> Med <input type="checkbox"/> Low <input type="checkbox"/> High	Upper boundary: K	Ramp Rate (0.1–100 K/min)	Control Input <input type="checkbox"/> Default <input type="checkbox"/> A <input type="checkbox"/> B <input type="checkbox"/> C <input type="checkbox"/> D
↑ Zone 03 ↓	Proportional (0.1–1000)	Integral (0.1–1000)	Derivative (0–200)	MHP Output (0–100%)	Heater Range <input type="checkbox"/> Off <input type="checkbox"/> Med <input type="checkbox"/> Low <input type="checkbox"/> High	Upper boundary: K	Ramp Rate (0.1–100 K/min)	Control Input <input type="checkbox"/> Default <input type="checkbox"/> A <input type="checkbox"/> B <input type="checkbox"/> C <input type="checkbox"/> D
↑ Zone 02 ↓	Proportional (0.1–1000)	Integral (0.1–1000)	Derivative (0–200)	MHP Output (0–100%)	Heater Range <input type="checkbox"/> Off <input type="checkbox"/> Med <input type="checkbox"/> Low <input type="checkbox"/> High	Upper boundary: K	Ramp Rate (0.1–100 K/min)	Control Input <input type="checkbox"/> Default <input type="checkbox"/> A <input type="checkbox"/> B <input type="checkbox"/> C <input type="checkbox"/> D
↑ Zone 01 ↓	Proportional (0.1–1000)	Integral (0.1–1000)	Derivative (0–200)	MHP Output (0–100%)	Heater Range <input type="checkbox"/> Off <input type="checkbox"/> Med <input type="checkbox"/> Low <input type="checkbox"/> High	Upper boundary: K	Ramp Rate (0.1–100 K/min)	Control Input <input type="checkbox"/> Default <input type="checkbox"/> A <input type="checkbox"/> B <input type="checkbox"/> C <input type="checkbox"/> D

FIGURE 5-1 Record of Zone settings

Menu Navigation:
Zones→Output (1 or 2)→Zones→(1 to 10)
Interface Command: ZONE

5.4 Bipolar Control

The most common type of temperature control output device is a resistive heater, which requires only unipolar output, since they will add heat regardless of the polarity of the excitation voltage. There are, however, temperature control devices that are bipolar. These devices, such as thermoelectric devices, can work in both polarities, moving heat from one side of the device to the other when a current is applied. Therefore, a surface can be heated or cooled using a bipolar temperature control device. For these types of bipolar devices, the Model 336 features a bipolar control mode. In this mode, the Model 336 is configured to drive these devices to control temperature using Output 3 and 4. Refer to section 2.11 for more information about thermoelectric devices.

To use Output 3 and 4 for bipolar control, first set the Heater Output Type parameter to Voltage, then set the polarity to Bipolar. The Closed Loop PID control mode can then be used to control a thermoelectric device, providing a control output of -10 V to +10 V. Refer to section 2.11 for information on thermoelectric devices. Refer to section 3.8.5.4 for information on scaling the output for voltages less than 10 V.

Menu Navigation:

Output Setup→**Output (3 or 4)**→**Polarity (Bipolar)**

Interface Command: **ANALOG**

5.5 Warm Up Supply

Warm Up Supply mode is designed for controlling an external power supply used for rapidly increasing the temperature in the controlled system, for example, to bring a system to room temperature in order to change samples. Refer to section 3.8.5 for information on using an external power supply for warm up supply mode.

The Control Input parameter determines which sensor is used for feedback in the Warm Up Supply mode. Refer to section 4.5.1.5 for details on the Control Input parameter.

Once Warm Up Supply Mode is configured, press **Setpoint** and set the desired temperature, then press **Heater Range** and set the range to On to activate the output. The front panel display must be configured to show the Warm Up control loop for the **Setpoint** and **Heater Range** keys to be used. Refer to section 4.2 and section 4.3 for details on front panel keypad operation and display setup.



The Power Up Enable feature determines if the output will remain on after power is cycled. Refer to section 4.5.1.2 for details on the Power Up Enable feature.

Menu Navigation:

Output Setup→**Output (3 or 4)**→**Output Mode**→**Warm Up Supply**

Interface Command: **OUTMODE**

5.5.1 Warm Up Percentage

The Warm Up Percentage parameter is used to determine the amount of voltage to apply to the unpowered output (3 or 4) when using Warm Up mode to control an external power supply. The voltage applied will be the full scale output (+10 V) times the Warm Up Percentage. For example, if the Warm Up Percentage is set to 50%, the control output voltage for the given unpowered output will be 50% of 10 V, or 5 V, when the output is on.

Menu Navigation:

Output Setup→**Output (3, or 4)**→**Warm Up Percentage**→(0% to 100%)

Default: 100%

Interface Command: **WARMUP**

5.5.2 Warm Up Control

The Warm Up Control parameter determines what happens when the control setpoint is reached. The options are:

- **Auto-Off:** once the Heater Range is set to on, the Warm Up Percentage voltage is applied to the output (section 5.5.1) and the output stays on until the control input temperature reaches the control setpoint. The output will then be turned off (0 V), and the Heater Range setting will automatically be set to Off, effectively turning off all temperature control for the control loop. If the Heater Range is again manually set to On, the cycle will begin again, and the output will turn on and stay on until the control input temperature reaches the setpoint again.

Menu Navigation:

Output Setup→*Output (3 or 4)*→*Warmup Mode*→Auto-Off

- **Continuous:** this mode implements what is often referred to as On/Off control. Once the Heater Range is set to on, the Warm Up Percentage voltage is applied to the output until the control input temperature reaches the setpoint. Then the output will turn off (0 V) until the temperature falls 1 K below the setpoint, at which point the the Warm Up Percentage voltage is again applied to the output. The Heater Range will never be automatically set to Off in this mode.

Menu Navigation:

Output Setup→*Output (3 or 4)*→*Warm Up Control*→(Auto-Off, Continuous)

Default: Continuous

Interface Command: **WARMUP**

5.6 Monitor Out

In Monitor Out mode, the unpowered analog output (3 or 4) will track the assigned control input according to the scaling parameters you enter. A common use for this function would be to send a voltage proportional to temperature to a data acquisition system.

The Control Input parameter setting determines which sensor input is tracked by the output. The remaining parameters detailed in this section dictate how the output value is determined.



An output configured to Monitor Out mode is not affected by the ALL OFF key, as it does not have a Heater Range setting, and by design is always enabled.

Menu Navigation:

Output Setup→*Output (3 or 4)*→*Output Mode*→Monitor Out

Output Setup→*Output (3 or 4)*→*Control Input*→(None, Input A, Input B, Input C, Input D)

Default: Control Input→None

Interface Command: **OUTMODE**

5.6.1 Monitor Units

The Monitor Units parameter determines the units of the Control Input sensor to use for creating the proportional voltage output. The Monitor Out scaling parameter settings are entered using the units chosen for this parameter.

Menu Navigation:

Output Setup→*Output (3 or 4)*→*Monitor Units*→(K, C, or Sensor)

Default: K

Interface Command: **ANALOG**

5.6.1.1 Polarity and Monitor Out Scaling Parameters

In the Monitor Out and Open Loop modes, the unpowered analog outputs can be configured as either unipolar (0 V to +10 V) or bipolar (−10 V to +10 V) outputs. In bipolar mode, the Monitor Out −10 V setting determines the temperature or sensor value at which the output should be −10 V. In unipolar mode, the Monitor Out 0 V setting determines the temperature or sensor value at which the output should be 0 V. The Monitor Out +10 V setting determines the temperature or sensor value at which the output should be +10 V in either unipolar or bipolar modes.

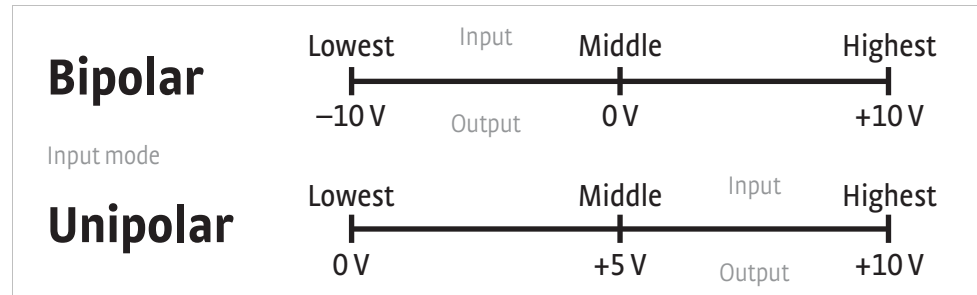

FIGURE 5-2 Unipolar and bipolar mode

For example, if Polarity is set to Bipolar, then setting the Monitor Out −10 V parameter to 0 K and the Monitor Out +10 V parameter to 100 K will cause the analog output to correspond to the input temperature as shown in FIGURE 5-3. In this case if the actual reading was 50 K, then the output would be at 0 V (middle of the scale).

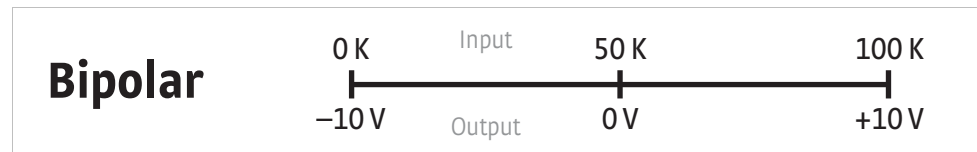

FIGURE 5-3 Analog output with polarity set to bipolar

If we set the Polarity parameter to Unipolar, the output would be as shown in FIGURE 5-4. In this case if the actual reading was 50 K, the analog output would be +5 V (middle of the scale).

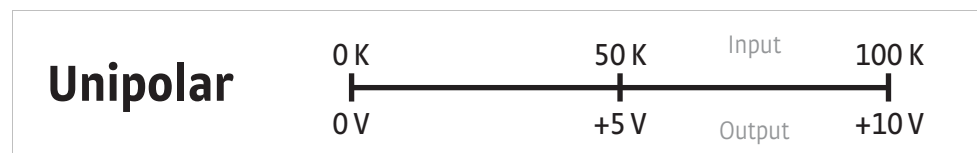

FIGURE 5-4 Output with polarity parameter set to unipolar

Menu Navigation:

Output Setup→Output (3 or 4)→Polarity→(Unipolar or Bipolar)

Output Setup→Output (3 or 4)→Monitor Out −10 V→(See note below)

Output Setup→Output (3 or 4)→Monitor Out 0 V→(See note below)

Output Setup→Output (3 or 4)→Monitor Out +10 V→(See note below)



Monitor Out −10 V, 0 V, and +10 V settings depend on the Monitor Units selected, and are limited to the acceptable values of the selected units.

Default: Polarity→Unipolar

Monitor Out −10 V→0.0000 K

Monitor Out 0 V→0.0000 K

Monitor Out +10 V→1000 K

Interface Command: **ANALOG**

5.7 Alarms and Relays

5.7.1 Alarms

Each input of the Model 336 has high and low alarm capability. Input reading data from any source can be compared to the alarm setpoint values. A reading higher than the high alarm setpoint triggers the high alarm for that input. A reading lower than the low alarm setpoint triggers the low alarm for that input.

Menu Navigation:

Alarm→Input (A, B, C, D)→Alarm→(Off, On)

Alarm→Input (A, B, C, D)→Low Setpoint→(see note below)

Alarm→Input (A, B, C, D)→High Setpoint→(see note below)



Low and High Setpoint limits are determined by the Preferred Units of the associated sensor input.

Defaults: Alarm→Off

Low Setpoint→0.0000 K

High Setpoint→1000 K

Interface Command: **ALARM**

5.7.1.1 Alarm Annunciators

The Alarm LED annunciator steadily displays when any alarm that is enabled also has the Visible parameter enabled. The annunciator flashes when any alarm that has the Visible parameter enabled activates. An input need not be displayed for the system Alarm annunciator to indicate input alarm status, but if the input is displayed on the front panel, then the reading will alternate between the alarm status message and the actual reading. If the Audible parameter is set to On for an enabled alarm, then the beeper inside the instrument will sound when the alarm activates. The two relays on the Model 336 can also be tied to alarm functions as described in section 5.7.2.

You may want to set the Visible parameter to Off if there is no need for showing the alarm state on the front panel, for instance, if you are using the alarm function to trigger a relay. The Audible parameter can be set to Off as well to keep the audible alarm from sounding when an alarm is triggered.

Menu Navigation:

Alarm→Input (A, B, C, D)→Visible→(Off, On)

Alarm→Input (A, B, C, D)→Audible→(Off, On)

Default: Visible→On

Audible→On

Interface Command: **ALARM**

5.7.1.2 Alarm Latching

- **Latching Alarms:** often used to detect faults in a system or experiment that requires operator intervention. The alarm state remains visible to the operator for diagnostics even if the alarm condition is removed. Relays often signal remote monitors, or for added safety take critical equipment off line. You can clear a latched alarm by pressing **Alarm** and selecting Yes to the Reset Alarm prompt. Select No to the Reset Alarm prompt to enter the Alarm Setup menu.
- **Non-Latching Alarms:** often tied to relay operation to control part of a system or experiment. The alarm state follows the reading value. The dead band parameter can prevent relays from turning on and off repeatedly when the sensor input reading is near an alarm setpoint.

FIGURE 5-5 illustrates the interaction between alarm setpoint and dead band in non-latching operation. With the high alarm setpoint at 100 K and the dead band at 5 K, the high alarm triggers when sensor input temperature increases to 100 K, and it will not deactivate until temperature drops to 95 K. In addition, the same 5 K dead band is applied to the low alarm setpoint as well.

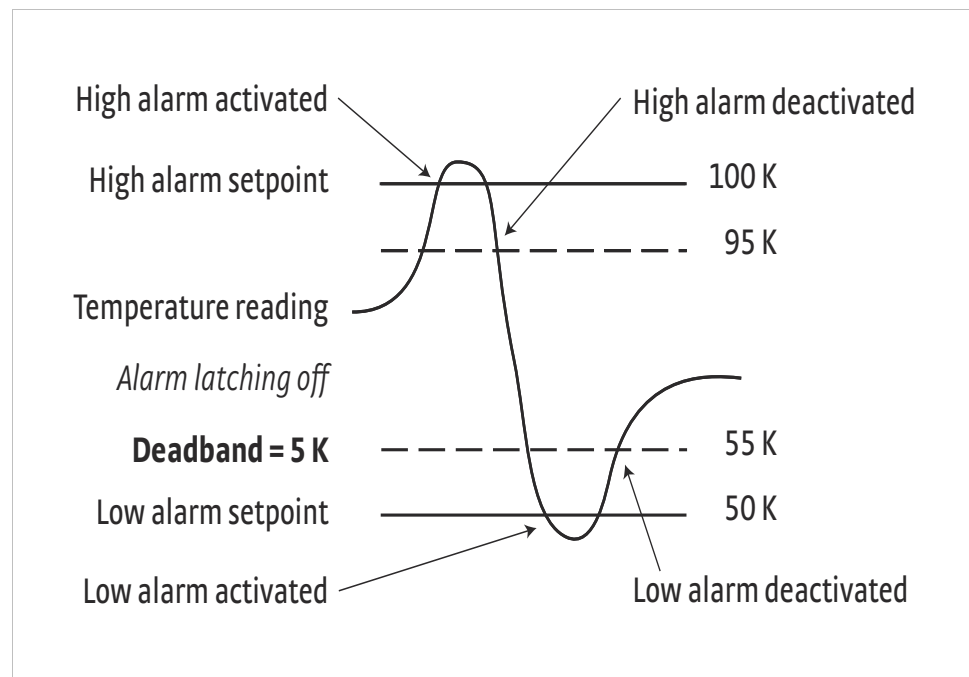

FIGURE 5-5 *Dead band example*

To setup an alarm, enter the Alarm Setup menu by pressing the Alarm key. If a latching alarm has been activated, you will be prompted with a Reset Alarm? message. Select No to enter the Alarm Setup menu.

Menu Navigation:

Alarm→Input (A, B, C, D)→Latching→(Off, On)

Alarm→Input (A, B, C, D)→Deadband→(see note below)



Low and High Setpoint limits are determined by the Preferred Units of the associated sensor input.

Default: *Latching*→Off

Deadband→1.0000 K

Interface Command: **ALARM**

5.7.2 Relays

There are two relays on the Model 336 numbered 1 and 2. They are most commonly thought of as alarm relays, but they may be manually controlled also. Relay assignments are configurable as shown in FIGURE 5-6. Two relays can be used with one sensor input for independent high and low operation, or each can be assigned to a different input.

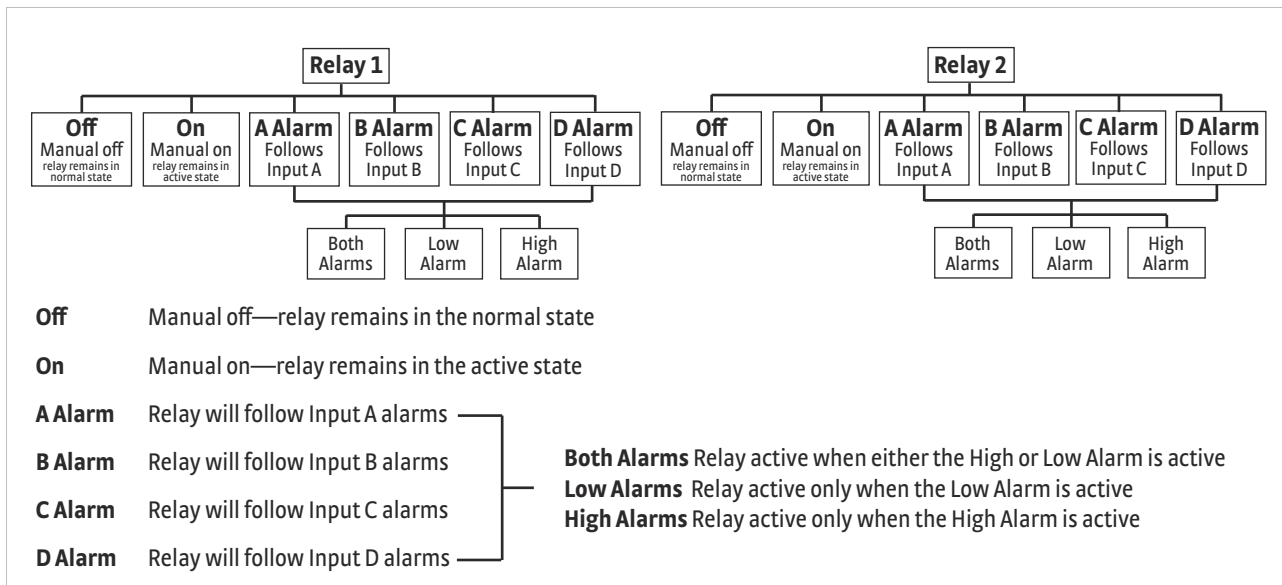

FIGURE 5-6 Relay settings

When using relays with alarm operation, set up alarms first. The relays are rated for 30 VDC and 3 A. Their terminals are in the detachable terminal block on the Model 336 rear panel.

In the Off mode, the relay is un-energized, leaving the normally open (NO) contacts open and the normally closed (NC) contacts closed. In the On mode, the relay is energized, so the NO contacts will be closed and the NC contacts will be open. In the Alarm mode the relay will activate based on the state of the configured Alarm Input sensor. When the Alarm to Follow parameter is set to Low, the relay will energize if the configured Alarm Input sensor goes into a low alarm state. If it is set to High, the relay will energize if the configured Alarm Input sensor goes into a high alarm state. If the Alarm to Follow parameter is set to Both, the relay will energize if the configured Alarm Input sensor goes into either a low alarm or a high alarm state.

Menu Navigation:

Relays→(Relay 1, Relay 2)→Mode→(Off, On, Alarm)

Relays→(Relay 1, Relay 2)→Alarm Input→Input (A, B, C, D)

Relays→(Relay 1, Relay 2)→Alarm to Follow→(Low, High, Both)

Default: Mode→Off

Alarm Input→Input A

Alarm to Follow→Both

Interface Command: **RELAY**

5.8 Curve Numbers and Storage

The Model 336 has 20 standard curve locations, numbered 1 through 20. At present, not all locations are occupied by curves; the others are reserved for future updates. If a standard curve location is in use, the curve can be viewed using the view operation. Standard curves cannot be changed by the user, and reserved locations are not available for user curves.

The Model 336 has 39 user curve locations, numbered 21 through 59. Each location can hold from 2 to 200 data pairs (breakpoints), including a value in sensor units and a corresponding value in kelvin. Using fewer than 200 breakpoints will not increase the number of available curve locations. SoftCal™-generated curves are stored in user curve locations.

5.8.1 Curve Header Parameters

Each curve has parameters that are used for identification and to allow the instrument to use the curve effectively. The parameters must be set correctly before a curve can be used for temperature conversion or temperature control.

- **Curve Number:** 1 to 59.
- **Name:** defaults to the name User Curve for front panel entry. A curve name of up to fifteen characters can be entered from either the front panel or from the computer interface. Refer to section 4.2.3 for Alpha-Numeric entry.
- **Serial Number:** a sensor serial number of up to ten characters (letters or numbers) can be entered from either the front panel or from the computer interface. Refer to section 4.2.3 for Alpha-Numeric entry. The default is blank.
- **Format:** the format parameter tells the instrument what breakpoint data format to expect. Different sensor types require different formats. Formats for Lake Shore sensors are described in TABLE 5-3.

Format	Description	Sensor Units Full Scale Range	Sensor Units Maximum Resolution
V/K	Volts vs. kelvin	10 V	0.00001 V
Ω /K	Resistance vs. kelvin for platinum RTD sensors	10 K Ω	0.001 Ω
Log Ω /K	Log resistance vs. kelvin for NTC resistive sensors	4 log Ω	0.00001 log Ω
mV/K	Millivolts vs. kelvin for thermocouple sensors	\pm 100 mV	0.0001 mV

TABLE 5-3 Curve header parameter

- **Setpoint Limit:** limits the control setpoint to values less than or equal to this setting. A setpoint limit can be included with every curve. Default is 375 K. Enter a setting of 9999 K if no limit is needed.
- **Temperature Coefficient:** the temperature coefficient is derived by the Model 336 from the first two breakpoints. The user does not enter this setting. If it is not correct, check for proper entry of the first two breakpoints. A positive coefficient indicates that the sensor signal increases with increasing temperature. A negative coefficient indicates that the sensor signal decreases with increasing temperature.

5.8.2 Curve Breakpoints

Temperature response data of a calibrated sensor must be reduced to a table of breakpoints before entering it into the instrument. A curve consists of 2 to 200 breakpoints and each breakpoint consists of one value in sensor units and one temperature value in kelvin. The Model 336 uses linear interpolation to calculate temperature between breakpoints. The instrument will show T.OVER or T.UNDER on the display if the sensor reading is outside the range of the breakpoints. Sensor units are defined by the format setting in TABLE 5-3.

Breakpoint setting resolution is six digits in temperature. Most temperature values are entered with 0.001 resolution. Temperature values of 1000 K and greater can be entered to 0.01 resolution. Temperature values below 10 K can be entered with 0.0001 resolution. Temperature range for curve entry is 0K to 9999.99 K.

Sensor Type	Typical Lake Shore Model	Format	Limit (K)	Temperature Coefficient	Typical Sensor Resolution
Silicon Diode	DT-670	V/K	475	Negative	0.00001 V
GaAlAs Diode	TG-120	V/K	325	Negative	0.00001 V
Platinum 100	PT-100	Ω /K	800	Positive	0.001 Ω
Platinum 1000	—*	Ω /K	800	Positive	0.01 Ω
Rhodium-Iron	RF-800	Ω /K	325	Positive	0.001 Ω
Carbon-Glass	CGR-1-1000	log Ω /K	325	Negative	0.00001 log Ω
Cernox™	CX-1050	log Ω /K	325	Negative	0.00001 log Ω
Germanium	GR-200A-100	log Ω /K	325	Negative	0.00001 log Ω
Rox™	RX-102A	log Ω /K	40	Negative	0.00001 log Ω
Type K	9006-005	mV/K	1500	Positive	0.0001 mV
Type E	9006-003	mV/K	930	Positive	0.0001 mV
Type T	9006-007	mV/K	673	Positive	0.0001 mV
Au-Fe 0.03%	—*	mV/K	500	Positive	0.0001 mV
Au-Fe 0.07%	9006-001	mV/K	610	Positive	0.0001 (mV)

*Not offered by Lake Shore

TABLE 5-4 Typical curve parameters

Setting resolution is also six digits in sensor units. The curve format parameter defines the range and resolution in sensor units as shown in TABLE 5-3. The sensor type determines the practical setting resolution. TABLE 5-4 lists recommended sensor units resolutions.

Enter the breakpoints with the sensor units value increasing as point number increases. There should not be any breakpoint locations left blank in the middle of a curve. The search routine in the Model 336 interprets a blank breakpoint as the end of the curve.

5.9 Front Panel Curve Entry Operations

There are five operations associated with front panel curve entry: Edit curve, View Curve, Erase Curve, Copy Curve, and SoftCal; as detailed below.

Operation	Description	Refer to section:
Edit Curve	Edit Curve allows you to edit curves at any user curve location. Standard curves cannot be changed.	5.9.1
View Curve	View Curve allows you to view any curve at any curve location. No curves can be changed.	5.9.2
Erase Curve	Erase Curve allows you to delete a curve from any user curve location. Standard curves cannot be erased.	5.9.3
Copy Curve	Copy Curve allows you to copy a curve from any location to any user curve location. Curves cannot be copied into standard curve locations.	5.9.4
SoftCal	SoftCal allows you to create a new temperature curve from a standard curve and known data points entered by the user.	5.10

TABLE 5-5 Front panel curve entry operations

Menu Navigation:

Curve Entry→(Edit Curve, View Curve, Erase Curve, Copy Curve, SoftCal)

5.9.1 Edit Curve

Use the Edit Curve operation to enter a new curve or edit an existing user curve. Only user curves (21 to 59) can be edited. Entering the identification parameters associated with the curve is as important as entering the breakpoints. Curve header parameters are listed in TABLE 5-3. Typical curve parameters for common sensors are listed in TABLE 5-4. Read this section completely and gather all necessary data before beginning the process.



If the curve you wish to enter has similar parameters as an existing curve, first copy the similar curve (as described in Section 5.2.4) to a new location, then edit the curve to the desired parameters.

To perform the Edit Curve operation, follow this procedure.

1. Press **Curve Entry**.
2. Scroll to **Edit Curve**, and press **Enter**.
3. Scroll to the desired curve and press **Enter** again.
4. Edit the curve header parameters using the standard keypad operation methods described in section 4.2.3. The curve breakpoints are entered in a slightly different way than other menu parameters.
5. To access the breakpoint data, highlight **Curve Points** in the Curve Edit menu screen and press **Enter** to enter the Curve Point entry screen.

The Curve Point entry screen contains a scrollable list of all curve breakpoint pairs in the selected curve. There are three columns in the list. From left to right the columns are: breakpoint number, breakpoint sensor value, breakpoint temperature value. Initially the highlight is on the first breakpoint number.

Menu Navigation:

Curve Entry → **Edit Curve**

Interface Command: **CRVHDR**

5.9.1.1 Edit a Breakpoint Pair

To edit a breakpoint pair, follow this procedure.

1. Select a breakpoint pair to edit. Do this by scrolling to the desired breakpoint number and press **Enter**. The highlight moves to the sensor value of the selected pair.
2. Use the Number Entry method to edit the value. Refer to section 4.2.1.1 for details on the Number Entry method.
3. Once the new sensor value is entered, press **Enter** to highlight the temperature value.
4. Use the Number Entry method to enter the new temperature value.
5. Press **Enter** at this point to store the new breakpoint pair.
6. Press **Escape** at any time when a sensor or temperature value is highlighted to cancel any changes to either of the values and return the highlight to the breakpoint number.

If the sensor value entered is not between the previous breakpoint sensor value and the following breakpoint sensor value, then the new breakpoint pair will be moved to the position in the curve that bounds the sensor value of the new breakpoint pair. If the pair is moved, a message will be displayed to indicate to the location to which the breakpoint pair was moved.

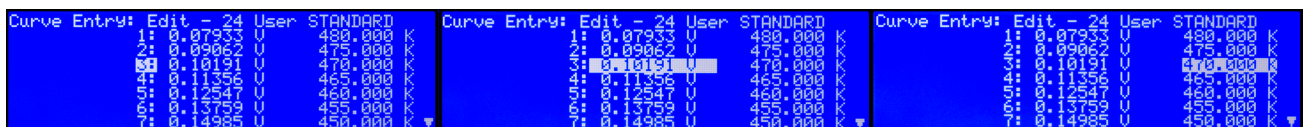

FIGURE 5-7 Left: Scroll to highlight a breakpoint number; Middle: Press the enter key to highlight the sensor value of the selected pair; Right: Press the enter key again, and the temperature value is highlighted

Menu Navigation:

Curve Entry → **Edit Curve** → (21–59) → **Curve Points** → (1–200)

Interface Command: **CRVPT**

5.9.1.2 Add a New Breakpoint Pair

The last breakpoint of a curve is signified by the first pair that contains a 0 value for both the temperature and sensor portions. Curves are limited to 200 breakpoint pairs, so if 200 pairs already exist, then the 200th pair will be the last pair in the list. To add a new breakpoint pair to a curve that has less than 200 pairs, scroll to the end of the list and edit the 0 value pair by following the procedure for editing a breakpoint pair in section 5.9.1.1. If the curve still contains less than 200 pairs, a new 0 value breakpoint will be added to the end of the list for entering another new breakpoint pair.

Menu Navigation:

Curve Entry → Edit Curve → (21–59) → Curve Points → (1–200)

Interface Command: CRVPT

5.9.1.3 Delete a Breakpoint Pair

To delete a breakpoint pair, scroll to the desired breakpoint number, then enter a 0 value for both the sensor and temperature values by following the procedure for editing a breakpoint pair in section 5.9.1.1.



If you are not entering 0 for both sensor and temperature values, then entering new values over an existing breakpoint pair will replace that pair with the new value when you press Enter.

After editing, adding, or deleting all desired breakpoint pairs, press **Escape** (Exit Menu) while the highlight is on a breakpoint number. All breakpoint pair changes, additions, and deletions will be saved when exiting the menu.

When curve entry is complete, you must assign the new curve to an input. The Model 336 does not automatically assign the new curve to any input. Refer to section 4.4.11 for details on assigning a curve to a sensor input.

Menu Navigation:

Curve Entry → Edit Curve → (21–59) → Curve Points → (1–200)

Interface Command: CRVPT

5.9.1.4 Thermocouple Curve Considerations

The following are things to consider when generating thermocouple curves.

- You may enter temperature response curves for all types of thermocouples. Enter curve data in mV/K format with thermocouple voltage in millivolts and temperature in kelvin.
- The curve must be normalized to 0 mV at 273.15 K (0 °C). Thermocouple voltages in millivolts are positive when temperature is above 273.15 K, and negative when temperature is below that point.
- To convert curves published in Celsius to kelvin, add 273.15 to the temperature in Celsius.
- The input voltage of the Model 336 is limited to ± 50 mV, so any part of the curve that extends beyond ± 50 mV is not usable by the instrument.
- A message of S.OVER or S.UNDER on the display indicates that the measured thermocouple input is over or under the ± 50 mV range.

5.9.2 View Curve

The View Curve operation provides read-only access to all standard and user curves.

To perform the View Curve operation follow this procedure.

1. Press **Curve Entry**, scroll to View Curve, then press **Enter**.
2. Scroll to the desired curve and press **Enter** again to view the curve header information.
3. To view the curve breakpoints, highlight the Curve Points parameter and press **Enter**. The list of breakpoint pairs is scrollable, but data cannot be edited.
4. Press **Escape** (Exit Menu) to return to the curve header parameter list.
5. Press **Escape** (Exit Menu) again to exit the Curve Entry menu and return to normal operation.

Menu Navigation:

Curve Entry → *View Curve*

Interface Command: **CRVHDR**, **CRVPT**

5.9.3 Erase Curve

You can erase user curves that are no longer needed. Erase Curve sets all identification parameters to default and blanks all breakpoint values.

To perform the Erase Curve operation follow this procedure.

1. Press **Curve Entry**, scroll to Erase Curve, then press **Enter**.
2. Scroll to the desired curve and press **Enter**.
3. Choose Yes at the confirmation message to finalize the operation.
4. To cancel the operation, either choose No to the confirmation message, or press **Escape**.

Menu Navigation:

Curve Entry → *Erase Curve* → (21-59)

Interface Command: **CRDEL**

5.9.4 Copy Curve

Temperature curves can be copied from one location inside the Model 336 to another. This is a good way to make small changes to an existing curve. Curve copy may also be necessary if you need the same curve with two different temperature limits or if you need to extend the range of a standard curve. The curve that is copied from is always preserved.



The copy routine allows you to overwrite an existing user curve. Please ensure the curve number you are writing to is correct before proceeding with the copy curve operation.

1. To perform the Copy Curve operation press **Curve Entry**, scroll to Copy Curve, then press **Enter**.
2. Scroll to the desired curve to copy, and press **Enter**. A list of user curves is displayed.
3. Scroll to the desired user curve location to copy to, and press **Enter**.
4. Choose Yes at the confirmation message to finalize the operation.
5. To cancel the operation, either choose No to the confirmation message, or press **Escape**.

Menu Navigation:

Curve Entry → *Copy Curve* → (1-59) → (21-59)

Interface Command: (No interface command directly corresponds to the copy curve operation. You can use the CRVHDR and CRVPT commands to read curve information from one curve location and write that information to another curve location.)

5.10 SoftCal™

The Model 336 allows you to perform inexpensive sensor calibrations with a set of algorithms called SoftCal™. The two SoftCal™ algorithms in the Model 336 work with DT-400 Series silicon diode sensors and platinum sensors. They create a new temperature response curve from the standard curve and known data points that you entered. The new curve loads into one of the user curve locations (21 to 59) in the instrument. The following sections describe the data points you need to supply and the expected accuracy of the resulting curves.



A feature similar to SoftCal™ is available for compensating thermocouples using the Curve Handler® program.

Both DT-400 Series and platinum SoftCal™ algorithms require a standard curve that is already present in the Model 336. When you enter the type of sensor being calibrated, the correct standard curve must be selected. When calibration is complete, you must assign the new curve to an input. The Model 336 does not automatically assign the newly generated curve to either input.

Calibration data points must be entered into the Model 336. These calibration points are normally measured at easily obtained temperatures like the boiling point of cryogenics. Each algorithm operates with 1, 2, or 3 calibration points. The range of improved accuracy increases with more points.

There are two ways to get SoftCal™ calibration data points: you can record the response of an unknown sensor at well controlled temperatures, or you can purchase a SoftCal™ calibrated sensor from Lake Shore. There are advantages to both methods.

- *User:* when you can provide stable calibration temperatures with the sensor installed, SoftCal™ calibration eliminates errors in the sensor measurement as well as the sensor. Thermal gradients, instrument accuracy, and other measurement errors can be significant to some users. Calibration can be no better than user-supplied data.
- *Purchased:* Lake Shore sensors with SoftCal™ calibration include a set of calibration points in the calibration report. The SoftCal™ calibration points are generated in a controlled calibration facility at Lake Shore for best accuracy. The calibration points can be entered into the Model 336 so it can generate a curve. If the CalCurve™ service is purchased with the calibrated sensor, the curve is also generated at the factory and can be entered like any other curve.

5.10.1 SoftCal™ With Silicon Diode Sensors

Lake Shore silicon diode sensors incorporate remarkably uniform sensing elements that exhibit precise, monotonic, and repeatable temperature response. For example, the Lake Shore DT-400 Series of silicon diode sensors have a repeatable temperature response from 2 K to 475 K. These sensors closely follow a standard curve. SoftCal™ is an inexpensive way to improve the accuracy of an already predictable sensor.

A unique characteristic of DT-400 Series diodes is that their temperature responses pass through 28 K at almost exactly the same voltage. This improves SoftCal™ algorithm operation by providing an extra calibration data point. It also explains why SoftCal™ calibration specifications are divided into two temperature ranges, above and below 28 K. See FIGURE 5-8.

- *Point 1:* calibration data point at or near the boiling point of helium, 4.2 K. Acceptable temperature entries are 2 K to 10 K. This data point improves between the calibration data point and 28 K. Points 2 and 3 improve temperatures above 28 K.
- *Point 2:* calibration data point at or near the boiling point of nitrogen (77.35 K). Temperatures outside 50 K to 100 K are not allowed. This data point improves accuracy between 28 K and 100 K. Points 2 and 3 together improve accuracy to room temperature and above.
- *Point 3:* calibration data point near room temperature (305 K). Temperatures outside the range of 200 K to 350 K are not allowed.

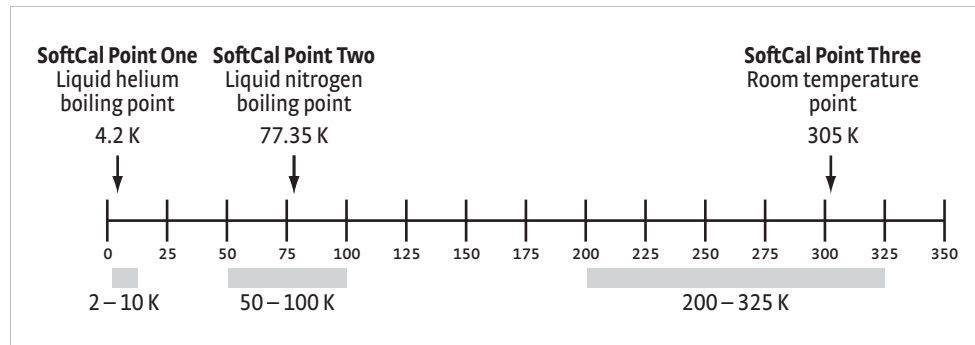

FIGURE 5-8 Acceptable temperature range for DT-400 series silicon diode SoftCal™ sensors

5.10.2 SoftCal™ Accuracy With DT-400 Series Silicon Diode Sensors

A SoftCal™ calibration is only as good as the accuracy of the calibration points. The accuracies listed for SoftCal™ assume ± 0.01 K for 4.2 K (liquid helium), ± 0.05 K for 77.35 K (liquid nitrogen), and 305 K (room temperature) points. Users performing the SoftCal™ with Lake Shore instruments should note that the boiling point of liquid cryogen, though accurate, is affected by atmospheric pressure. Use calibrated standard sensors if possible.

One-point SoftCal™ calibrations for applications under 30 K are performed at liquid helium (4.2 K) temperature. Accuracy for the DT-470-SD-13 diode is ± 0.5 K from 2 K to <30 K with no accuracy change above 30 K.

Two-point SoftCal™ calibrations for applications above 30 K are performed at liquid nitrogen (77.35 K) and room temperature (305 K). Accuracy for the DT-470-SD-13 diode sensor is as follows:

± 1.0 K	2 K to <30 K (no change below 30 K)
± 0.25 K	30 K to <60 K
± 0.15 K	60 K to <345 K
± 0.25 K	345 K to <375 K
± 1.0 K	375 to 475 K

TABLE 5-6 2-point SoftCal™ calibration accuracy for DT-470-SD-13 diode sensors

Three-point SoftCal™ calibrations are performed at liquid helium (4.2 K), liquid nitrogen (77.35 K), and room temperature (305 K). Accuracy for the DT-470-SD-13 diode sensor is as follows:

± 0.5 K	2 K to <30 K
± 0.25 K	30 K to <60 K
± 0.15 K	60 K to <345 K
± 0.25 K	345 K to <375 K
± 1.0 K	375 to 475 K

TABLE 5-7 3-point SoftCal™ calibration accuracy for DT-470-SD-13 diode sensors

5.10.3 SoftCal™ With Platinum Sensors

The platinum sensor is a well-accepted temperature standard because of its consistent and repeatable temperature response above 30 K. SoftCal™ gives platinum sensors better accuracy than their nominal matching to the DIN 43760 curve.

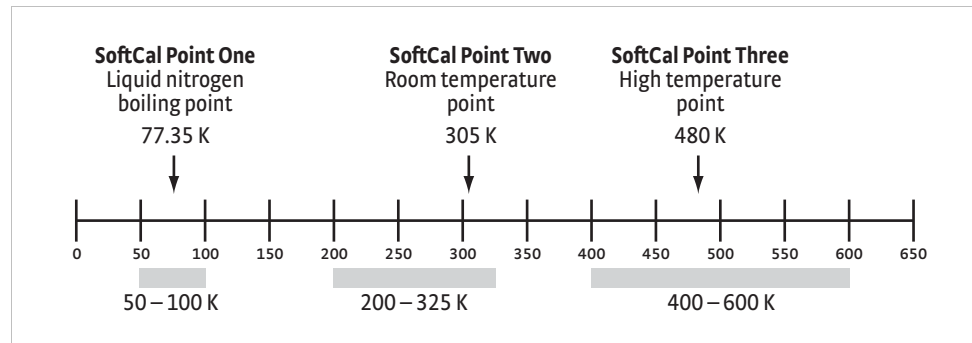

FIGURE 5-9 Acceptable temperature range for platinum SoftCal™ sensors

One, two, or three calibration data points can be used. If you are using one point, the algorithm shifts the entire curve up or down to meet the single point. If you are using two points, the algorithm has enough information to tilt the curve, achieving good accuracy between the data points. The third point extends the improved accuracy to span all three points.

- **Point 1:** calibration data point at or near the boiling point of nitrogen (77.35 K). Acceptable temperature entries are 50 K to 100 K.
- **Point 2:** calibration data point near room temperature (305 K). Acceptable temperature entries are 200 K to 300 K.
- **Point 3:** calibration data point at a higher temperature (480 K). Acceptable temperature entries are 400 K to 600 K.

5.10.4 SoftCal™ Accuracy With Platinum Sensors

A SoftCal™ calibration is only as good as the accuracy of the calibration points. The accuracies listed for SoftCal™ assume ± 0.05 K for 77.35 K (liquid nitrogen) and 305 K (room temperature) points. If you are performing the SoftCal™ with Lake Shore instruments, note that the boiling point of liquid cryogen, though accurate, is affected by atmospheric pressure. Use calibrated standard sensors if possible.

One-point SoftCal™ calibrations with platinum sensors have no specified accuracy.

Two-point SoftCal™ calibrations for applications above 70 K are performed at liquid nitrogen (77.35 K) and room temperature (305 K). Accuracy for the PT-102, PT-103, or PT-111 platinum sensor is as follows:

± 250 mK	70 K to 325 K
± 500 mK	325 K to ± 1400 mK at 480 K

(DIN class A or class B tolerance)

TABLE 5-8 Three-point SoftCal™ calibration accuracy for DT-470-SD-13 diode sensors

Three-point SoftCal™ calibrations are performed at liquid nitrogen (77.35 K), room temperature (305 K), and high temperature (480 K). Accuracy for the PT-102, PT-103, or PT-111 platinum sensor is ± 250 mK from 70 K to 325 K, and ± 250 mK from 325 K to 480 K.

5.10.5 SoftCal™ Calibration Curve Creation

Once the calibration data points have been obtained, you may create a SoftCal™ calibration. Press **Curve Entry**, then scroll to **Softcal** and press **Enter**. A list of sensor types is displayed containing DT-470, PT-100, and PT 1000. Scroll to the desired sensor type and press **Enter**. A list of SoftCal™ parameters is displayed.

Use the **Store Location** parameter to choose the user curve location in which to store the newly generated curve. If desired, use the **Serial Number** parameter to enter a serial number for the newly generated curve. Use the **Point X Temp** and **Point X Sensor** parameters to enter calibration data point X, where X can be point 1, 2, or 3. If only 1 or 2 data points were acquired, only enter those data points and leave the others at their default values. Note the acceptable temperature ranges for each calibration data point in FIGURE 5-8 and FIGURE 5-9. If a temperature value outside of the acceptable range is entered, the value will be limited to the closest acceptable value.

Once the data points are entered, highlight **Generate Softcal** and press **Enter**. Choose **Yes** at the confirmation message to finalize the operation. To cancel the operation, either choose **No** to the confirmation message, or press **Escape**. When the Softcal™ curve has been generated, the following message will appear on the display:
 *** SoftCal curve has been generated ***



The Generate Softcal operation will overwrite an existing user curve. Please ensure the curve number you are writing to is correct before generating the calibrated curve.

You can check the new curve using the **View Curve** instructions in section 5.9.2. The curve is not automatically assigned to any input, so you will need to assign it to an input. Refer to section 4.4.1.1 for details on assigning a curve to a sensor input.

Menu Navigation:

Curve Entry → **Softcal** → (*DT-470, Platinum 100, Platinum 1000*) → **Data Entry** (see note below) → (*Generate Softcal*) → (*Yes*)

Interface Command: **SCAL**



Data entry includes new curve serial number and calibration points.

Chapter 6: Computer Interface Operation

6.1 General

This chapter provides operational instructions for the computer interface for the Lake Shore Model 336 temperature controller. Each of the three computer interfaces provided with the Model 336 permit remote operation. The first is the IEEE–488 interface described in section 6.2. The second is the USB interface described in section 6.3. The third is the Ethernet interface described in section 6.4. The three interfaces share a common set of commands detailed in section 6.6. Only one of the interfaces can be used at a time.

6.2 IEEE-488 Interface

The IEEE–488 interface is an instrumentation bus with hardware and programming standards that simplify instrument interfacing. The Model 336 IEEE–488 interface complies with the IEEE-488.2 standard and incorporates its functional, electrical, and mechanical specifications unless otherwise specified in this manual.

All instruments on the interface bus perform one or more of the interface functions of Talker, Listener, or Bus Controller. A Talker transmits data onto the bus to other devices. A Listener receives data from other devices through the bus. The Bus Controller designates to the devices on the bus which function to perform. The Model 336 performs the functions of Talker and Listener, but it cannot be a Bus Controller. The Bus Controller is the digital computer that tells the Model 336 which functions to perform.

TABLE 6-1 defines the IEEE–488 capabilities and subsets for the Model 336:

Subset	Capabilities
SH1:	Source handshake capability
RL1:	Complete remote/local capability
DC1:	Full device clear capability
DT0:	No device trigger capability
CO:	No system controller capability
T5:	Basic Talker, serial poll capability, talk only, unaddressed to talk if addressed to listen
L4:	Basic Listener, unaddressed to listen if addressed to talk
SR1:	Service request capability
AH1:	Acceptor handshake capability
PP0:	No parallel poll capability
E1:	Open collector electronics

TABLE 6-1 Model 336 IEEE-488 interface capabilities and their subsets

Instruments are connected to the IEEE–488 bus by a 24-conductor connector cable as specified by the standard (section 8.10.1). Cables can be ordered from Lake Shore as IEEE-488 Cable Kit 4005, or they can be purchased from other electronic suppliers.

Cable lengths are limited to 2 m (6.6 ft) for each device and 20 m (65.6 ft) for the entire bus. The Model 336 can drive a bus with up to ten loads. If more instruments or cable length is required, a bus expander must be used.

6.2.1 Changing IEEE-488 Interface Parameters

The IEEE-488 address must be set from the front panel before communication with the instrument can be established.

Menu Navigation:

Interface→Enabled→IEEE-488

Interface→IEEE-488 Address→(1 to 31)

Default: IEEE-488

6.2.2 Remote/Local Operation

Normal operations from the keypad are referred to as local operations. The Model 336 can also be configured for remote operations via the IEEE-488 interface or the **Remote/Local** key. The **Remote/Local** key will toggle between remote and local operation. During remote operations, the remote annunciator LED will be illuminated, and operations from the keypad will be disabled.

6.2.3 IEEE-488.2 Command Structure

The Model 336 supports several command types. These commands are divided into four groups.

1. Bus Control (section 6.2.3.1).
 - a. Universal
 - Uniline
 - Multiline
 - b. Addressed bus control
2. Common (section 6.2.3.2).
3. Device Specific (section 6.2.3.3).
4. Message Strings (section 6.2.3.4).

6.2.3.1 Bus Control Commands

A bus control command can either be a universal or an addressed bus control. A universal command addresses all devices on the bus. Universal commands include uniline and multiline commands. A uniline command (message) asserts only a single signal line. The Model 336 recognizes two of these messages from the Bus Controller: Remote (REN) and Interface Clear (IFC). The Model 336 sends one uniline command: Service Request (SRQ).

- REN (Remote): puts the Model 336 into remote mode
- IFC (Interface Clear): stops current operation on the bus
- SRQ (Service Request): tells the bus controller that the Model 336 needs interface service

A multiline command asserts a group of signal lines. All devices equipped to implement such commands do so simultaneously upon command transmission. These commands transmit with the Attention (ATN) line asserted low. The Model 336 recognizes two multiline commands:

- LLO (Local Lockout): prevents the use of instrument front panel controls
- DCL (Device Clear): clears Model 336 interface activity and puts it into a bus idle state

Finally, addressed bus control commands are multiline commands that must include the Model 336 listen address before the instrument responds. Only the addressed device responds to these commands. The Model 336 recognizes three of the addressed bus control commands:

- SDC (Selective Device Clear): the SDC command performs essentially the same function as the DCL command, except that only the addressed device responds
- GTL (Go To Local): the GTL command is used to remove instruments from the remote mode. With some instruments, GTL also unlocks front panel controls if they were previously locked out with the LLO command.

- SPE (Serial Poll Enable) and SPD (Serial Poll Disable): serial polling accesses the Service Request Status Byte Register. This status register contains important operational information from the unit requesting service. The SPD command ends the polling sequence.

6.2.3.2 Common Commands

Common commands are addressed commands that create commonality between instruments on the bus. All instruments that comply with the IEEE-488 standard share these commands and their format. Common commands all begin with an asterisk. They generally relate to bus and instrument status and identification. Common query commands end with a question mark (?). Model 336 common commands are detailed in section 6.6.1 and summarized in TABLE 6-6.

6.2.3.3 Device Specific Commands

Device specific commands are addressed commands. The Model 336 supports a variety of device specific commands to program instruments remotely from a digital computer and to transfer measurements to the computer. Most device specific commands also work if performed from the front panel. Model 336 device specific commands are detailed in section 6.6.1 and summarized in TABLE 6-6.

6.2.3.4 Message Strings

A message string is a group of characters assembled to perform an interface function. There are three types of message strings: commands, queries and responses. The computer issues command and query strings through user programs, and the instrument issues responses. Two or more command strings or queries can be chained together in one communication, but they must be separated by a semi-colon (;). The total communication string must not exceed 255 characters in length.

A command string is issued by the computer and instructs the instrument to perform a function or change a parameter setting. When a command is issued, the computer is acting as talker and the instrument as listener. The format is:

```
<command mnemonic><space><parameter data><terminator>.
```

Command mnemonics and parameter data necessary for each one is described in section 6.6.1. A terminator must be sent with every message string.

A query string is issued by the computer and instructs the instrument which response to send. Queries are issued similar to commands with the computer acting as talker and the instrument as listener. The query format is:

```
<query mnemonic><?><space><parameter data><terminator>.
```

Query mnemonics are often the same as commands with the addition of a question mark. Parameter data is often unnecessary when sending queries. Query mnemonics and parameter data if necessary is described in section 6.6.1. A terminator must be sent with every message string. Issuing a query does not initiate a response from the instrument.

A response string is sent by the instrument only when it is addressed as a talker and the computer becomes the listener. The instrument will respond only to the last query it receives. The response can be a reading value, status report or the present value of a parameter. Response data formats are listed along with the associated queries in section 6.6.1.

6.2.4 Status System Overview

The Model 336 implements a status system compliant with the IEEE-488.2 standard. The status system provides a method of recording and reporting instrument information and is typically used to control the Service Request (SRQ) interrupt line. A diagram of the status system is shown in FIGURE 6-1. The status system is made up of status register sets, the Status Byte register, and the Service Request Enable register. Each register set consists of three types of registers: condition, event, and enable.

6.2.4.1 Condition Registers

Each register set (except the Standard Event Register set) includes a condition register as shown in FIGURE 6-1. The condition register constantly monitors the instrument status. The data bits are real-time and are not latched or buffered. The register is read-only.

6.2.4.2 Event Registers

Each register set includes an event register as shown in FIGURE 6-1. Bits in the event register correspond to various system events and latch when the event occurs. When an event bit is set, subsequent events corresponding to that bit are ignored. Set bits remain latched until the register is cleared by a query command (such as *ESR?) or a *CLS command. The register is read-only.

6.2.4.3 Enable Registers

Each register set includes an enable register as shown in FIGURE 6-1. An enable register determines which bits in the corresponding event register will set the summary bit for the register set in the Status Byte. You may write to or read from an enable register. Each event register bit is logically ANDed to the corresponding enable bit of the enable register. When you set an enable register bit, and the corresponding bit is set in the event register, the output (summary) of the register will be set, which in turn sets the summary bit of the Status Byte register.

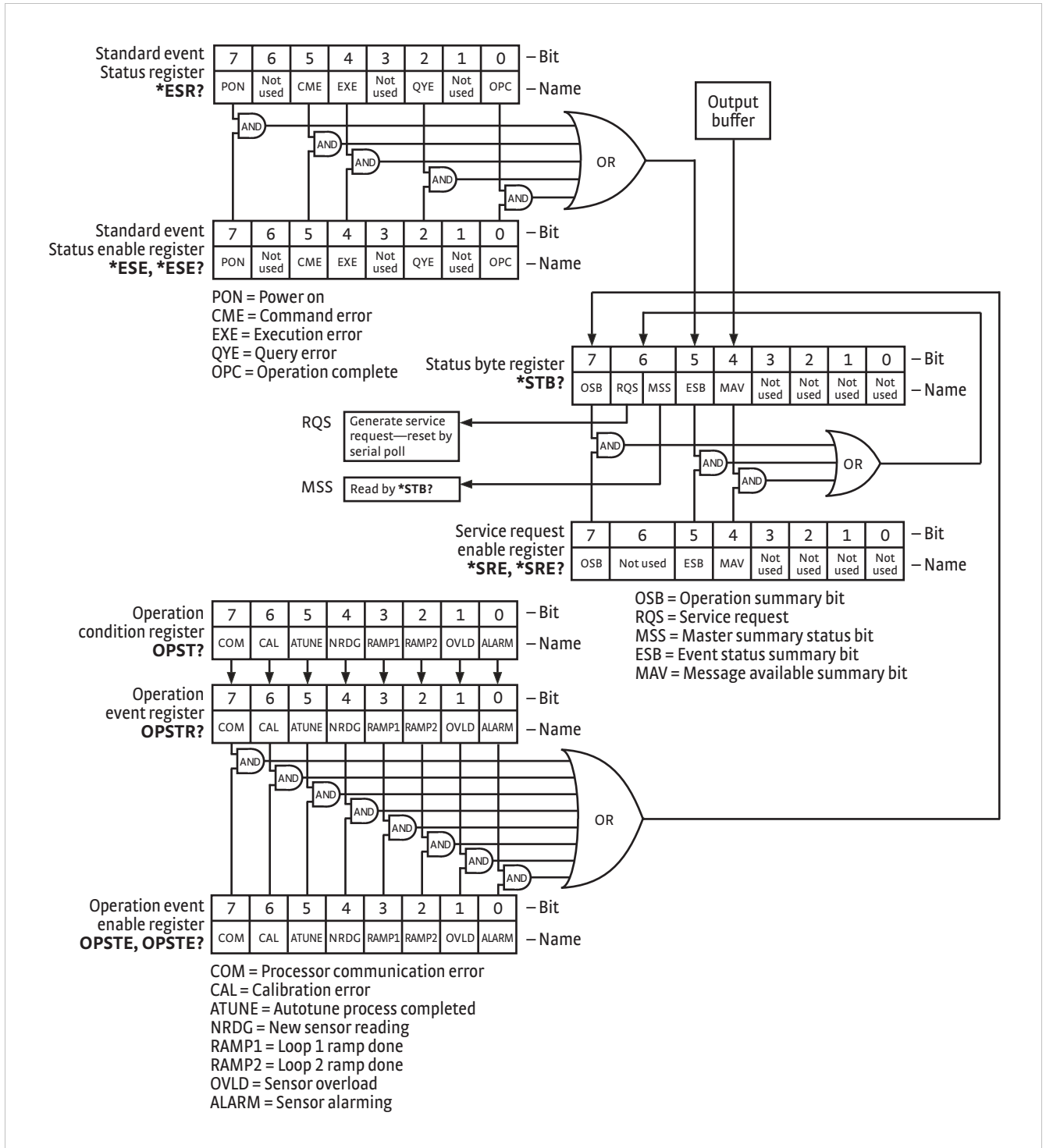

FIGURE 6-1 Model 336 status system

6.2.4.4 Status Byte Register

The Status Byte register, typically referred to as the Status Byte, is a non-latching, read-only register that contains all of the summary bits from the register sets. The status of the summary bits are controlled from the register sets as explained in section 6.2.4.1 to section 6.2.4.3. The Status Byte also contains the Request for Service (RQS)/Master Summary Status (MSS) bit. This bit is used to control the Service Request hardware line on the bus and to report if any of the summary bits are set via the *STB? command. The status of the RQS/MSS bit is controlled by the summary bits and the Service Request Enable Register.

6.2.4.5 Service Request Enable Register

The Service Request Enable Register determines which summary bits in the Status Byte will set the RQS/MSS bit of the Status Byte. You may write to or read from the Service Request Enable Register. Each Status Byte summary bit is logically ANDed to the corresponding enable bit of the Service Request Enable Register. When you set a Service Request Enable Register bit, and the corresponding summary bit is set in the Status Byte, the RQS/MSS bit of the Status Byte will be set, which in turn sets the Service Request hardware line on the bus.

6.2.4.6 Reading Registers

You can read any register in the status system using the appropriate query command. Some registers clear when read, others do not (section 6.2.4.8). The response to a query will be a decimal value that corresponds to the binary-weighted sum of all bits in the register (TABLE 6-2). The actual query commands are described later throughout section 6.2.4.

Position	B7	B6	B5	B4	B3	B2	B1	B0
Decimal	128	64	32	16	8	4	2	1
Weighting	2^7	2^6	2^5	2^4	2^3	2^2	2^1	2^0

Example: If bits 0, 2, and 4 are set, a query of the register will return a decimal value of 21 ($1+4+16$).

TABLE 6-2 Binary weighting of an 8-bit register

6.2.4.7 Programming Registers

The only registers that may be programmed by the user are the enable registers. All other registers in the status system are read-only registers. To program an enable register, send a decimal value that corresponds to the desired binary-weighted sum of all bits in the register (TABLE 6-2). The actual commands are described throughout (section 6.2.4).

6.2.4.8 Clearing Registers

The methods to clear each register are detailed in TABLE 6-3.

Register	Method	Example
Condition registers	None. Registers are not latched	—
Event registers: Standard event status register Operation event register	Query the event register	*ESR? (clears Standard Event Status Register)
	Send *CLS	*CLS (clears both registers)
	Power on instrument	—
Enable registers Standard Event Status Enable Register Operation Event Enable Register Service Request Enable Register	Write 0 to the enable register	*ESE 0 (clears Standard Event Status Enable register)
	Power on instrument	—
Status byte	There are no commands that directly clear the status byte as the bits are non-latching; to clear individual summary bits clear the event register that corresponds to the summary bit—sending *CLS will clear all event registers which in turn clears the status byte	If bit 5 (ESB) of the status byte is set, send *ESR? to read the standard event status register and bit 5 will clear
	Power on instrument	—

TABLE 6-3 Register clear methods

6.2.5 Status System Detail: Status Register Sets

As shown in FIGURE 6-1, there are two register sets in the status system of the Model 336: Standard Event Status Register and Operation Event Register.

6.2.5.1 Standard Event Status Register Set

The Standard Event Status Register reports the following interface related instrument events: power on detected, command syntax errors, command execution errors, query errors, operation complete. Any or all of these events may be reported in the standard event summary bit through the enable register (FIGURE 6-2). The Standard Event Status Enable command (*ESE) programs the enable register and the query command (*ESE?) reads it. *ESR? reads and clears the Standard Event Status Register. The used bits of the Standard Event Register are described as follows:

- Power On (PON), Bit (7): this bit is set to indicate an instrument off-on transition.
- Command Error (CME), Bit (5): this bit is set if a command error has been detected since the last reading. This means that the instrument could not interpret the command due to a syntax error, an unrecognized header, unrecognized terminators, or an unsupported command.
- Execution Error (EXE), Bit (4): this bit is set if an execution error has been detected. This occurs when the instrument is instructed to do something not within its capabilities.
- Query Error (QYE), Bit (2): this bit indicates a query error. It occurs rarely and involves loss of data because the output queue is full.
- Operation Complete (OPC), Bit (0): when *OPC is sent, this bit will be set when the instrument has completed all pending operations. The operation of this bit is not related to the *OPC? command, which is a separate interface feature (section 6.2.6.6).

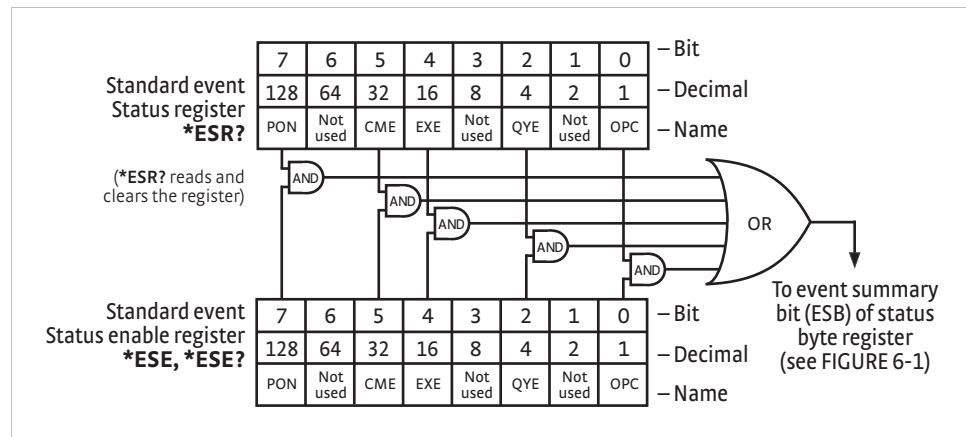

FIGURE 6-2 Standard event status register

6.2.5.2 Operation Event Register Set

The Operation Event Register reports the interface related instrument events listed below. Any or all of these events may be reported in the operation event summary bit through the enable register (FIGURE 6-3). The Operation Event Enable command (OPSTE) programs the enable register and the query command (OPSTE?) reads it. OPSTR? reads and clears the Operation Event Register. OPST? reads the Operation Condition register. The used bits of the Operation Event Register are described as follows:

- Processor Communication Error (COM), Bit (7): this bit is set when the main processor cannot communicate with the sensor input processor
- Calibration Error (CAL), Bit (6): this bit is set if the instrument is not calibrated or the calibration data has been corrupted
- Autotune Done (ATUNE), Bit (5): this bit is set when the Autotuning algorithm is NOT active
- New Sensor Reading (NRDG), Bit (4): this bit is set when there is a new sensor reading
- Loop 1 Ramp Done (RAMP1), Bit (3): this bit is set when a loop 1 setpoint ramp is completed
- Loop 2 Ramp Done (RAMP2), Bit (2): this bit is set when a loop 2 setpoint ramp is completed
- Sensor Overload (OVL), Bit (1): this bit is set when a sensor reading is in the overload condition
- Alarming (ALARM), Bit (0): this bit is set when an input is in an alarming state, and the Alarm Visible parameter is on

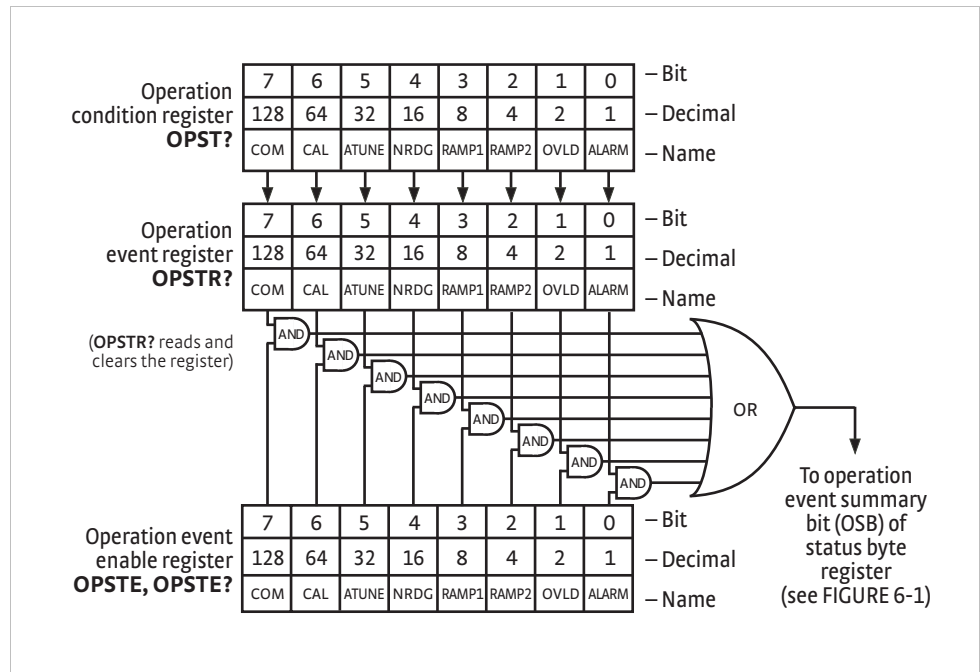

FIGURE 6-3 Operation event register

6.2.6 Status System Detail: Status Byte Register and Service Request

As shown in FIGURE 6-1, the Status Byte Register receives the summary bits from the two status register sets and the message available summary bit from the output buffer. The status byte is used to generate a service request (SRQ). The selection of summary bits that generates an SRQ is controlled by Service Request Enable Register.

6.2.6.1 Status Byte Register

The summary messages from the event registers and output buffer set or clear the summary bits of the Status Byte Register (FIGURE 6-4). These summary bits are not latched. Clearing an event register will clear the corresponding summary bit in the Status Byte Register. Reading all messages in the output buffer, including any pending queries, will clear the message available bit. The bits of the Status Byte Register are described as follows:

- Operation Summary (OSB), Bit (7): this bit is set when an enabled operation event has occurred
- Request Service (RQS)/Master Summary Status (MSS), Bit (6): this bit is set when a summary bit and the summary bit’s corresponding enable bit in the Service Request Enable Register are set. Once set, the user may read and clear the bit in two different ways, which is why it is referred to as both the RQS and the MSS bit. When this bit goes from low to high, the Service Request hardware line on the bus is set; this is the RQS function of the bit (section 6.2.6.3). In addition, the status of the bit may be read with the *STB? query, which returns the binary weighted sum of all bits in the Status Byte; this is the MSS function of the bit.

Performing a serial poll will automatically clear the RQS function, but it will not clear the MSS function. A *STB? will read the status of the MSS bit (along with all of the summary bits), but also will not clear it. To clear the MSS bit, either clear the event register that set the summary bit or disable the summary bit in the Service Request Enable Register.

- Event Summary (ESB), Bit (5): this bit is set when an enabled standard event has occurred
- Message Available (MAV), Bit (4): this bit is set when a message is available in the output buffer

6.2.6.2 Service Request Enable Register

The Service Request Enable Register is programmed by the user and determines which summary bits of the Status Byte may set bit 6 (RQS/MSS) to generate a Service Request. Enable bits are logically ANDed with the corresponding summary bits (FIGURE 6-4). Whenever a summary bit is set by an event register and its corresponding enable bit is set by the user, bit 6 will set to generate a service request. The Service Request Enable command (*SRE) programs the Service Request Enable Register and the query command (*SRE?) reads it.

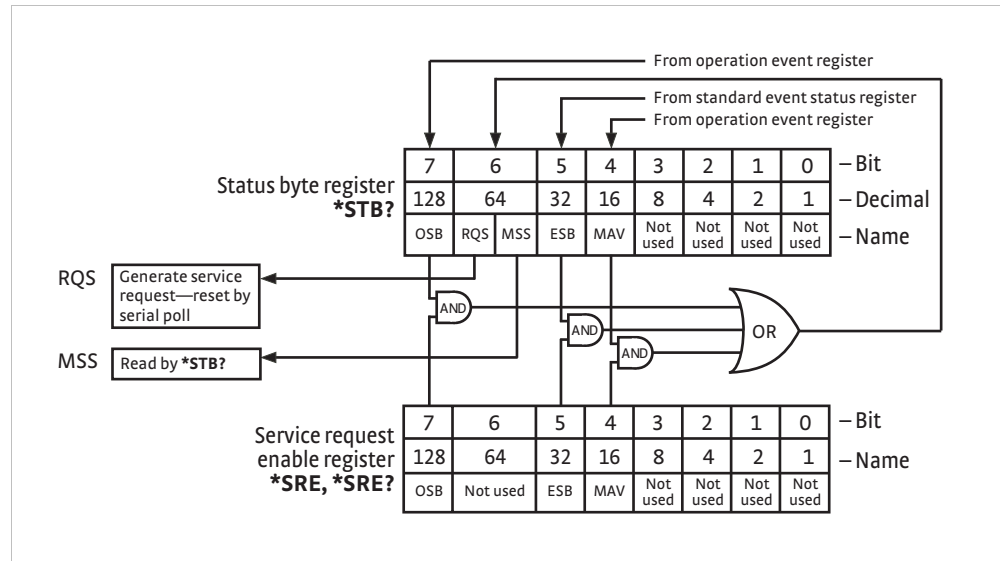

FIGURE 6-4 Status byte register and service request enable register

6.2.6.3 Using Service Request (SRQ) and Serial Poll

When a Status Byte summary bit (or MAV bit) is enabled by the Service Request Enable Register and goes from 0 to 1, bit 6 (RQS/MSS) of the status byte will be set. This will send a service request (SRQ) interrupt message to the bus controller. The user program may then direct the bus controller to serial poll the instruments on the bus to identify which one requested service (the one with bit 6 set in its status byte).

Serial polling will automatically clear RQS of the Status Byte Register. This allows subsequent serial polls to monitor bit 6 for an SRQ occurrence generated by other event types. After a serial poll, the same event or any event that uses the same Status Byte summary bit, will not cause another SRQ unless the event register that caused the first SRQ has been cleared, typically by a query of the event register.

The serial poll does not clear MSS. The MSS bit stays set until all enabled Status Byte summary bits are cleared, typically by a query of the associated event register (section 6.2.6.4).

The programming example in TABLE 6-4 initiates an SRQ when a command error is detected by the instrument.

Command or Operation	Description
*ESR?	Read and clear the Standard Event Status Register
*ESE 32	Enable the Command Error (CME) bit in the Standard Event Status Register
*SRE 32	Enable the Event Summary Bit (ESB) to set the RQS
*ABC	Send improper command to instrument to generate a command error
Monitor bus	Monitor the bus until the Service Request interrupt (SRQ) is sent.
Initiate serial poll	Serial poll the bus to determine which instrument sent the interrupt and clear the RQS bit in the Status Byte.
*ESR?	Read and clear the Standard Event Status Register allowing an SRQ to be generated on another command error.

TABLE 6-4 Programming example to generate an SRQ

6.2.6.4 Using Status Byte Query (*STB?)

The Status Byte Query (*STB?) command is similar to a serial poll except it is processed like any other instrument command. The *STB? command returns the same result as a serial poll except that the Status Byte bit 6 (RQS/MSS) is not cleared. In this case, bit 6 is considered the MSS bit. Using the *STB? command does not clear any bits in the Status Byte Register.

6.2.6.5 Using the Message Available (MAV) Bit

Status Byte summary bit 4 (MAV) indicates that data is available to read into the bus controller. This message may be used to synchronize information exchange with the bus controller. The bus controller can, for example, send a query command to the Model 336 and then wait for MAV to set. If the MAV bit has been enabled to initiate an SRQ, the user's program can direct the bus controller to look for the SRQ leaving the bus available for other use. The MAV bit will be clear whenever the output buffer is empty.

6.2.6.6 Using Operation Complete (*OPC) and Operation Complete Query (*OPC?)

The Operation Complete (*OPC) and Operation Complete Query (*OPC?) are both used to indicate when pending device operations complete. However, the commands operate with two distinct methods.

The *OPC command is used in conjunction with bit 0 (OPC) of the Standard Event Status Register. If *OPC is sent as the last command in a command sequence, bit 0 will be set when the instrument completes the operation that was initiated by the command sequence. Additional commands may be sent between the instrument and the bus controller while waiting for the initial pending operation to complete. A typical use of this function would be to enable the OPC bit to generate an SRQ and include the *OPC command when programming the instrument. The bus controller could then be instructed to look for an SRQ allowing additional communication with the instrument while the initial process executes.

The *OPC? query has no interaction with bit 0 (OPC) of the Standard Event Status Register. If the *OPC? query is sent at the end of a command sequence, the bus will be held until the instrument completes the operation that was initiated by the command sequence. Additional commands (except *RST) should not be sent until the operation is complete, as erratic operation will occur. Once the sequence is complete a 1 will be placed in the output buffer. This function is typically used to signal a completed operation without monitoring the SRQ. It is also used when it is important to prevent any additional communication on the bus during a pending operation.

6.3 USB Interface

The Model 336 USB interface provides a convenient way to connect to most modern computers, as a USB interface is provided on nearly all new PCs as of the writing of this manual. The USB interface is implemented as a virtual serial com port connection. This implementation provides a simple migration path for modifying existing RS-232 based remote interface software. It also provides a simpler means of communicating than a standard USB implementation.

6.3.1 Physical Connection

The Model 336 has a B-type USB connector on the rear panel. This is the standard connector used on USB peripheral devices, and it allows the common USB A-type to B-type cable to be used to connect the Model 336 to a host PC. The pin assignments for A-type and B-type connectors are shown in section 8.10. The maximum length of a USB cable, as defined by the USB 2.0 standard, is 5 m (16.4 ft). This length can be extended using USB hubs every 5 m (16.4 ft) up to five times, for a maximum total length of 30 m (98.4 ft).

6.3.2 Hardware Support

The USB interface emulates an RS-232 serial port at a fixed 57,600 baud rate, but with the physical connections of a USB. This programming interface requires a certain configuration to communicate properly with the Model 336. The proper configuration parameters are listed in TABLE 6-5.

Baud rate	57,600
Data bits	7
Start bits	1
Stop bits	1
Parity	Odd
Flow control	None
Handshaking	None

TABLE 6-5 *Host com port configuration*

The USB hardware connection uses the full speed (12,000,000 bits/sec) profile of the USB 2.0 standard; however, since the interface uses a virtual serial com port at a fixed data rate, the data throughput is still limited to a baud rate of 57,600 bits/s.

6.3.3 Installing the USB Driver

The Model 336 USB driver has been made available through Windows® Update. This is the recommended method for installing the driver, as it will ensure that you always have the latest version of the driver installed. If you are unable to install the driver from Windows® Update, refer to section 6.3.3.3 to install the driver from the web or from the disc provided with the Model 336.

These procedures assume that you are logged into a user account that has administrator privileges.

6.3.3.1 Installing the Driver From Windows® Update in Windows 7 and Vista®

1. Connect the USB cable from the Model 336 to the computer.
2. Turn on the Model 336.
3. When the Found New Hardware wizard appears, select **Locate and install driver software (recommended)**.
4. If User Account Control(UAC) is enabled, a UAC dialog box may appear asking if you want to continue. Click **Continue**.
5. The Found New Hardware wizard should automatically connect to Windows® Update and install the drivers.



If the Found New Hardware wizard is unable to connect to Windows® Update or find the drivers, a message to “Insert the disc that came with your Lake Shore Model 336” will be displayed. Click Cancel and refer to section 6.3.3.3 to install the driver from the web.

- When the Found New Hardware wizard finishes installing the driver, a confirmation message stating “the software for this device has been successfully installed” will appear. Click Close to complete the installation.

6.3.3.2 Installing the Driver From Windows® Update in Windows® XP

- Connect the USB cable from the Model 336 to the computer.
- Turn on the Model 336.
- When the Found New Hardware wizard appears, select **Yes, this time only** and click **Next**.
- Select **Install the software automatically (Recommended)** and click **Next**.
- The Found New Hardware wizard should automatically connect to Windows® Update and install the drivers.



If the Found New Hardware wizard is unable to connect to Windows® Update or find the drivers, a message saying **Cannot Install this Hardware** will be displayed. Click the **Cancel** button and refer to section 6.3.3.3 to install the driver from the web.

- When the Found New Hardware wizard finishes installing the driver a confirmation message stating “the wizard has finished installing the software for Lake Shore Model 336 Temperature Controller” will appear. Click **Finish** to complete the installation.

6.3.3.3 Installing the Driver From the Web

The Model 336 USB driver is available on the Lake Shore website. To install the driver it must be downloaded from the website and extracted. Use the procedure in section 6.3.3.1 through section 6.3.3.4 to download, extract, and install the driver using Windows 7, Vista® and XP.

6.3.3.3.1 Download the driver:

- Locate the Model 336 USB driver on the downloads page on the Lake Shore website.
- Right-click on the USB driver download link, and select **save target/link as**.
- Save the driver to a convenient place, and take note as to where the driver was downloaded.

6.3.3.3.2 Extract the driver:

The downloaded driver is in a ZIP compressed archive. The driver must be extracted from this file. Windows® provides built-in support for ZIP archives. If this support is disabled, a third-party application, such as WinZip™ or 7-Zip, must be used.

For Windows 7 and Vista®:

- Right click on the file and click **extract all**.
- An Extract Compressed (Zipped) Folders dialog box will appear. It is recommended the default folder is not changed. Take note of this folder location.
- Click to clear the **Show extracted files when complete** checkbox, and click **Extract**.

For Windows® XP

- Right-click on the file and click **extract all**.
- The Extraction wizard will appear. Click **Next**.

3. It is recommended to keep the same default folder. Take note of this folder location and click **Next**.
4. An “Extraction complete” message will be displayed. Click to clear the **Show extracted files** checkbox, and click **Finish**.

6.3.3.3 Manually install the driver

Manually installing drivers differ between versions of Windows®. The following sections describe how to manually install the driver using Windows 7, Vista® and XP. To install the driver you must be logged into a user account that has administrator privileges.

For Windows 7 and Vista®

1. Connect the USB cable from the Model 336 to the computer.
2. Turn on the Model 336.
3. If the Found New Hardware wizard appears, click **Ask me again later**.
4. Open Device Manager. Use this procedure to open Device Manager.
 - a. Click the Windows® **Start** button and type Device Manager in the **Start Search** box.
 - b. Click on the Device Manager link in the Search Results Under Programs dialog box.
 - c. If User Account Control is enabled click **Continue** on the User Account Control prompt.
5. Click **View** and ensure the **Devices by Type** check box is selected.
6. In the main window of Device Manager, locate **Other Devices** in the list of device types. In many instances this will be between Network adapters and Ports (COM & LPT). If the **Other Devices** item is not already expanded, click the + icon. Lake Shore Model 336 should appear indented underneath **Other Devices**. If it is not displayed as Lake Shore Model 336, it might be displayed as USB Device. If neither are displayed, click **Action** and then **Scan for hardware changes**, which may open the Found New Hardware wizard automatically. If the Found New Hardware wizard opens, click **Cancel**.
7. Right-click on Lake Shore Model 336 and click **Update Driver Software**.
8. Click **Browse my computer for driver software**.
9. Click **Browse** and select the location of the extracted driver.
10. Ensure the **Include subfolders** check box is selected and click **Next**.
11. When the driver finishes installing a confirmation message stating “Windows has successfully updated your driver software” should appear. Click **Close** to complete the installation.

For Windows® XP

1. Connect the USB cable from the Model 336 to the computer.
2. Turn on the Model 336.
3. The Found New Hardware wizard should appear. If the Found New Hardware wizard does not appear, the following procedure can be used to open the Hardware Update wizard which can be used instead:
 - a. Open Device Manager. Use this procedure to open the Device Manager:
 - Right-click on **My Computer** and then click **Properties**. This will open the System Properties dialog.
 - Click the **Hardware** tab and then click **Device Manager**.
 - b. Click **View** and ensure the **Devices by Type** check box is selected.

- c. In the main window of Device Manager, locate the **Ports (COM & LPT)** device type. In many instances this will be between the Network adapters and Processors items. If the **Ports (COM & LPT)** item is not already expanded, click the + icon. Lake Shore Model 336 should appear indented underneath **Ports (COM & LPT)**. If it is not displayed as Lake Shore Model 336, it might be displayed as USB Device. If neither are displayed, click **Action** and then select **Scan for hardware changes**, which may open the Found New Hardware wizard automatically. If the Found New Hardware wizard opens, continue to step 4.
 - d. Right-click on Lake Shore Model 336 and click **Update Driver**.
4. Select **No, not at this time** and click **Next**.
 5. Select **Search for the best driver in these locations**, click to clear the **Search removable media (floppy, CD-ROM...)** check box, and click the **Include this location in the search** check box.
 6. Click **Browse** and open the location of the extracted driver.
 7. Click **Next**.
 8. When the driver finishes installing a confirmation message stating “The wizard has finished installing the software for Lake Shore Model 336 Temperature Controller” should appear. Click **Finish** to complete the installation.

6.3.3.4 Installing the USB Driver from the Included CD

The Model 336 USB driver is available on the included CD. The following section describes the process of installing the driver from the CD. To install the driver you must be logged into a user account that has administrator privileges.

For Windows 7 and Vista®

1. Insert the CD into the computer.
2. Follow steps 1–9 of the Windows 7 and Vista® procedure in section 6.3.3.3.3.
3. Click **Browse** and select the drive containing the included CD.
4. Ensure the **Include subfolders** check box is selected and click **Next**.
5. When the driver finishes installing a confirmation message stating “Windows has successfully updated your driver software” should appear. Click **Close** to complete the installation.

For Windows® XP

1. Insert the CD into the computer.
2. Connect the USB cable from the Model 336 to the computer.
3. Turn on the Model 336.
4. When the Found New Hardware wizard appears select **No, not at this time** and click **Next**.
5. Select **Install the software automatically (recommended)** and click **Next**.
6. The Found New Hardware wizard should automatically search the CD and install the drivers.
7. When the Found New Hardware Wizard finishes installing the drivers a message stating “the wizard has finished installing the software for Lake Shore Model 336 Temperature Controller” should appear. Click **Finish** to complete the installation.

6.3.4 Communication

Communicating via the USB interface is done using message strings. The message strings should be carefully formulated by the user program according to some simple rules to establish effective message flow control.

6.3.4.1 Character Format

A character is the smallest piece of information that can be transmitted by the interface. Each character is ten bits long and contains data bits, bits for character timing, and an error detection bit. The instrument uses seven bits for data in the American Standard Code for Information Interchange (ASCII) format. One start bit and one stop bit are necessary to synchronize consecutive characters. Parity is a method of error detection. One parity bit configured for odd parity is included in each character.

ASCII letter and number characters are used most often as character data. Punctuation characters are used as delimiters to separate different commands or pieces of data. A special ASCII character, line feed (LF OAH), is used to indicate the end of a message string. This is called the message terminator. The Model 336 will accept either the line feed character alone, or a carriage return (CR ODH) followed by a line feed as the message terminator. The instrument query response terminator will include both carriage return and line feed.

6.3.4.2 Message Strings

A message string is a group of characters assembled to perform an interface function. There are three types of message strings: commands, queries, and responses. The computer issues command and query strings through user programs, the instrument issues responses. Two or more command or query strings can be chained together in one communication, but they must be separated by a semi-colon (;). The total communication string must not exceed 255 characters in length.

A command string is issued by the computer and instructs the instrument to perform a function or change a parameter setting. The format is:

<command mnemonic><space><parameter data><terminators>.

Command mnemonics and parameter data necessary for each one is described in section 6.6. Terminators must be sent with every message string.

A query string is issued by the computer and instructs the instrument to send a response. The query format is:

<query mnemonic><?><space><parameter data><terminators>.

Query mnemonics are often the same as commands with the addition of a question mark. Parameter data is often unnecessary when sending queries. Query mnemonics and parameter data if necessary is described in section 6.6. Terminators must be sent with every message string. The computer should expect a response very soon after a query is sent.

A response string is the instrument's response or answer to a query string. The response can be a reading value, status report or the present value of a parameter. Response data formats are listed along with the associated queries in section 6.6. The response is sent as soon as possible after the instrument receives the query.

6.3.5 Message Flow Control

It is important to remember that the user program is in charge of the USB communication at all times. The instrument cannot initiate communication, determine which device should be transmitting at a given time, or guarantee timing between messages. All of this is the responsibility of the user program.

When issuing commands the user program alone should:

- Properly format and transmit the command including the terminator as 1 string
- Guarantee that no other communication is started for 50 ms after the last character is transmitted
- Not initiate communication more than 20 times per second

When issuing queries or queries and commands together, the user program should:

- Properly format and transmit the query including the terminator as 1 string
- Prepare to receive a response immediately
- Receive the entire response from the instrument including the terminator
- Guarantee that no other communication is started during the response or for 50 ms after it completes
- Not initiate communication more than 20 times per second

Failure to follow these simple rules will result in inability to establish communication with the instrument or intermittent failures in communication.

6.4 Ethernet Interface

The Ethernet interface provides a means of connecting the Model 336 to an Ethernet based computer network. Ethernet networks provide the ability to communicate across large distances, often using existing equipment (the internet, pre-existing local networks). The Ethernet interface of the Model 336 provides the ability to use TCP socket connections (section 6.4.3) to send commands and queries to the instrument using the common command set detailed in section 6.6. The Model 336 has an embedded web interface that provides status information and additional utilities (section 6.5).

Menu Navigation:

Interface→Enabled→Ethernet

6.4.1 Ethernet Configuration

There are several parameters for configuring the Model 336 Ethernet interface and three methods for configuring these parameters. This section contains a brief explanation of each of these. A comprehensive discussion of computer networking is beyond the scope of this manual. These settings may depend on your network configuration; contact your network administrator for assistance.

6.4.1.1 Network Address Parameters

Network address parameters include the IP address, the subnet mask, and the gateway address. The network address parameters of the Model 336 can be configured using one of three methods: DHCP, Auto-IP, or Static-IP. See section 6.4.1.2 for details on each of these configuration methods.

- *IP Address:* an IP address is required for a device to communicate using TCP/IP, which is the protocol generally used for Ethernet devices and the Model 336. The IP version used by the Model 336 is IPv4. The IPv6 standard is not supported. All references to the IP protocol from this point forward will be referring to IPv4.

An IP address is a 32-bit logical address used to differentiate devices on a network. It is most often given in dotted decimal notation, such as nnn.nnn.nnn.nnn where nnn is a decimal number from 0 to 255.

- *Subnet Mask:* a sub network, or subnet, is a group of devices within a network that have a common, designated IP address routing prefix. A subnet mask is a 32-bit “bit mask” that signifies which part of the IP address represents the subnet routing prefix, and which part represents the device’s address on the subnet. A subnet mask is most often given in dotted decimal notation, such as nnn.nnn.nnn.nnn where nnn is a decimal number from 0 to 255. When converted to a binary notation, the 32-bit subnet mask should consist of a contiguous group of ones, followed by a contiguous group of zeros. The ones represent which bits in the IP address refer to the subnet, and the zeros represent which bits refer to the device address. For example, the default Static-IP Address of the Model 336 is 192.168.0.12, and the default Static Subnet Mask is 255.255.255.0. Converting this subnet mask to binary shows that the first 24 bits are ones, and the last 8 bits

are zeros. This means that the first 24 bits of the Static-IP Address (192.168.0) represent the subnet, and the last 8 bits (12) represent the device.

- **Gateway Address:** a gateway is a network traffic routing device that is used to route communication between networks. If a gateway is not used, then devices on a network can only communicate with other devices on that same network. A Gateway Address is the IP address of the gateway on a network. Contact the network administrator for the gateway address for your network.

6.4.1.2 Network Addresss Configuration Methods

The network address parameters of the Model 336 can be configured using one of three methods: DHCP, Auto-IP, or Static-IP. DHCP and Auto-IP are automatic configuration methods, and Static-IP requires manual configuration. If supported by the server, DHCP can also be used to automatically configure DNS server addresses, as well as IP address parameters.

An order of precedence is followed when the Model 336 attempts to acquire IP address parameters. If enabled, the DHCP method will be used first. If DHCP is disabled, or if the attempt to acquire parameters from the DHCP server fails, the Model 336 then checks if Auto-IP is enabled. If Auto-IP is enabled, this method will be used. If disabled, or if this attempt fails, the Static-IP method will be used. If the Static-IP method fails, the IP address parameters will not be configured and the Ethernet status will enter an error state. Refer to section 6.4.2.1 if you receive an error message.

Dynamic Host Configuration Protocol (DHCP): DHCP is a method of automatically configuring the IP address, subnet mask, and gateway of Ethernet devices on a network. This method provides simple automatic configuration for users connecting to a network that provides a DHCP server. The network DHCP server will provide an IP address, subnet mask, and gateway address. Depending on the DHCP server configuration, it may also provide primary DNS and secondary DNS addresses as well. DHCP is the simplest method of IP configuration. DHCP does have the disadvantage of not necessarily preserving the IP address through a device reconfiguration, as well as the possibility of being automatically reconfigured when the DHCP “lease” expires. Contact your network administrator to find out the DHCP lease policy on your network.

To use DHCP to automatically configure the IP address, subnet mask, and gateway of the Model 336, simply connect the Model 336 to a network that provides a DHCP server, and set the DHCP parameter to On. By default, the DHCP feature of the Model 336 is On.

Menu Navigation:

Interface → *Modify IP Config* → DHCP → (Off or On)

Auto-IP: Auto-IP is a method of automatically configuring the IP address and subnet mask parameters of Ethernet devices on a link-local network. This configuration is performed by the Model 336 and does not require any external device. Auto-IP is defined in RFC 3927 “Dynamic Configuration of IPv4 Link-Local Addresses” and can be found at The Internet Engineering Task Force website at www.ietf.org. The automatically configured address will be in the link-local address group of 169.254.1.0 to 169.254.254.255. This group is reserved for independent, local networks that do not connect to other networks. This method chooses an IP address that is not already active on the network, which eliminates IP address conflicts. A gateway address is not applicable when using Auto-IP, since the purpose of a gateway address is to commu-

nicate with outside networks, and by definition Auto-IP only works on link-local networks. A disadvantage of Auto-IP is the limitation of only working with a link-local network, which cannot connect to other networks, including the internet. Another disadvantage lies in the fact that an Auto-IP assigned address will not be preserved through a device reconfiguration, such as a power cycle.

To use Auto-IP to automatically configure a link-local IP address and subnet mask, set the DHCP parameter to Off, then set the Auto-IP parameter to On. By default, the Auto-IP feature of the Model 336 is Off.

Menu Navigation:

Interface → *Modify IP Config* → Auto-IP → (Off or On)

Static-IP: Static-IP is a method of manually configuring the IP address, subnet mask, and gateway of Ethernet enabled devices. When using the Static-IP method, the IP address, subnet mask, and gateway must be configured appropriately for the connected network, or for the connected PC, in order to establish connection to the network. A major advantage to the Static-IP method is that the IP address will not change during device reconfiguration (power cycle). Disadvantages of using the Static-IP method include the requirement of knowing how your network is configured in order to choose the correct configuration parameters.

The Static-IP method is always enabled, and therefore will default to this method when both automatic configuration methods (DHCP and Auto-IP) are disabled, or if all enabled automatic configuration methods fail. To use Static-IP to manually configure the IP address, subnet mask, and gateway of the Model 336, set the DHCP and the Auto-IP parameters to Off. Refer to the paragraphs above for details on turning off DHCP and Auto-IP. The Model 336 will now use the Static-IP Address, Static Subnet Mask, Static Gateway, Static Primary DNS, and Static Secondary DNS parameters to attempt to configure the Ethernet interface connection. Refer to section 6.4.1.3 for details on DNS parameters. Contact your network administrator for the appropriate Static-IP parameters for your network.

Menu Navigation:

Interface → *Modify IP Config* → Static-IP → (Valid IP Address)

Interface → *Modify IP Config* → Static Subnet Mask → (Valid Subnet Mask)

Interface → *Modify IP Config* → Static Gateway → (Valid IP Address)

Interface → *Modify IP Config* → Static Pri DNS → (Valid IP Address)

Interface → *Modify IP Config* → Static Sec DNS → (Valid IP Address)

6.4.1.3 DNS Parameters

The parameters discussed in this section exist to facilitate the use of the Domain Name System (DNS) to connect to the Model 336 using assignable names rather than cryptic IP addresses. This functionality is provided for convenience only, and is not critical to the connectivity of the Ethernet interface.

DNS Address: A Domain Name System (DNS) is a service that translates names into IP addresses. This service allows for using human readable names for devices on a network. As an example, when a web browser attempts to retrieve the web page at www.lakeshore.com, the browser first performs a forward-lookup on the assigned DNS server to attempt to retrieve the IP address that is represented by the name www.lakeshore.com. If successful, the web browser then uses the retrieved IP address to communicate with the web server that hosts the website at www.lakeshore.com.

The Model 336 can be configured to communicate with a primary and a secondary DNS server using the Primary DNS Address and the Secondary DNS Address parameters. Multiple DNS servers are sometimes used for redundancy, but multiple servers are not required, and not all networks provide a DNS server. DNS addresses can be configured automatically using the DHCP method if the network DHCP server is configured to do so.



Your DHCP server must be configured appropriately to provide DNS server addresses. Not all DHCP servers provide this functionality on your network.

Hostname: A hostname is a name that is assigned to a device on a network. On a Domain Name System (DNS) enabled network, a hostname can be used alone when connecting from another device on the same domain, or it can be combined with a domain name to connect to devices outside of the local domain. For example, www.lakeshore.com refers to the Lake Shore web server on the Internet, which is a DNS enabled network. The web server hostname is “www”, and it resides on the domain “lakeshore.com”. To connect to the web server from another device on the lakeshore.com domain, only the hostname “www” must be used. To connect from any other domain on the Internet, the entire fully-qualified name, consisting of the hostname and the domain name (www.lakeshore.com) must be used. Hostnames can only contain alpha-numeric characters and hyphens, but cannot begin or end with a hyphen.

A hostname can be assigned by a network administrator, or if the Model 336 is connected to a network with Dynamic DNS (DDNS) capability, a DNS entry is automatically created for it using the Preferred Hostname and Preferred Domain Name parameters and the assigned IP address.

Menu Navigation:

Interface → *Modify IP Config* → Preferred Hostname → (Valid Hostname String)

If DNS reverse-lookup is enabled on the network DNS server, and the DNS address parameters are correctly configured, the Model 336 will perform a reverse-lookup to determine if a hostname is assigned for the Model 336’s configured IP address. This will occur regardless of whether the hostname was configured dynamically using DDNS, or manually by the network administrator. The returned hostname will appear in the Actual Hostname parameter, in the View IP Config submenu of the Interface Setup menu.

Menu Navigation (Read Only):

Interface → *View IP Config* → Actual Hostname



When using naming systems other than DNS, the Model 336 cannot assign the Preferred Hostname or retrieve the Actual Hostname.

Domain Name: A domain is a collection of network devices that are managed according to some common characteristic of its members. Domains can contain subdomains which are subsets within the domain. The hierarchy can contain several dot separated levels which flow from right to left. For example, lakeshore.com contains the top-level-domain “com” and the subdomain “lakeshore”. When using the Domain Name System (DNS) to connect to a specific host device on a network, the device’s hostname is tacked onto the left of the domain name. For example, the “www” in www.lakeshore.com refers to the Lake Shore web server, located within the internet domain “lakeshore.com.”

If the Model 336 is connected to a network with Dynamic DNS (DDNS) capability, a DNS entry is automatically created using the Preferred Hostname and Preferred Domain Name parameters and the assigned IP address. The Preferred Domain Name parameter can only be accessed using the NET interface command (section 6.6.1), or by using the Ethernet configuration page (section 6.4.2) of the embedded website on the Model 336.

If DNS reverse-lookup is enabled on the network DNS server, and the DNS address parameters are correctly configured, the Model 336 will perform a reverse-lookup to determine if a domain name is assigned for the Model 336's configured IP address. This will occur regardless of whether the domain name was configured dynamically using DDNS, or manually by the network administrator. The returned domain name will appear in the Actual Hostname parameter, in the View IP Config submenu of the Interface Setup menu.



When using naming systems other than DNS, the Model 336 cannot assign the Preferred Domain Name or retrieve the Actual Domain Name.

Menu Navigation:

The Preferred Domain name can only be entered using a computer interface NET command, and viewed using the NET? query. Refer to section 6.6.1 for details on the NET command and query.

6.4.2 Viewing Ethernet Configuration

When the Ethernet interface is enabled, two submenus become available: Modify IP Config, and View IP Config. All configurable settings are available under the Modify IP Config submenu, and the current state of the Ethernet configuration is detailed in the View IP Config submenu. This is designed to eliminate confusion as to which are the configurable Static-IP settings, and which are the currently configured settings that could have been configured using any of the three configuration methods (DHCP, Auto-IP, or Static-IP). The method used for the currently established connection is shown in the LAN Status parameter of the View IP Config submenu (section 6.4.2.1).

6.4.2.1 LAN Status

The LAN Status parameter indicates the current status of the Ethernet configuration. This read-only parameter can be accessed using the View IP Config menu.

The possible LAN Status states are:

- Connected–Static: the IP address parameters have been successfully configured using the Static-IP method
- Connected–DHCP: the IP address parameters have been successfully configured using the DHCP method
- Connected–AutoIP: the IP address parameters have been successfully configured using the AutoIP method
- Addr Not Acquired: the IP address parameters were not successfully configured.
- Duplicate Init IP: when initially attempting to connect to the network, the Static-IP address was found to be in use by another device already configured on the network. The Model 336 interface will remain unconfigured until an available Static-IP address is entered.
- Duplicate Ong IP: an ongoing conflict occurred after being successfully connected to the network, because another device on the network was configured using the same IP address. The Model 336 will automatically unconfigure and remain unconfigured until an available IP address is entered.
- Cable Unplugged: the Ethernet cable is either unplugged at one end, or has been damaged

- Module Error: the Model 336 has lost contact with the Ethernet module; this may indicate a damaged Ethernet module
- Acquiring Address: the Model 336 is attempting to configure the IP address parameters using the enabled methods

6.4.2.2 MAC Address

The Media Access Controller (MAC) Address is a physical hardware address assigned to all Ethernet devices. MAC addresses are 48-bits and are generally written as six groups of two hexadecimal digits separated by colons, for example “01:23:45:67:89:AB”. Unlike IP addresses, MAC addresses are tied to the device hardware and cannot be changed.

Menu Navigation (Read-Only):

Interface→View IP Config→MAC Address

6.4.2.3 Viewing Network Configuration Parameters and DNS Parameters

The currently configured network parameters are displayed individually in the View IP Config submenu. These parameters could have been configured using either DHCP, Auto-IP, or Static-IP. The LAN Status parameter shows which method was used for the current configuration. When in an error state, or in the intermediate Acquiring Address state, the network configuration parameters will all be displayed as 0.0.0.0. Refer to section 6.4.1.1 through section 6.4.1.3 for details on network configuration parameters and DNS parameters.

Menu Navigation (Read-Only):

Interface→View IP Config→IP

Interface→View IP Config→Subnet Mask

Interface→View IP Config→Gateway IP

Interface→View IP Config→Primary DNS IP

Interface→View IP Config→Secondary DNS IP

Interface→View IP Config→Actual Hostname

Interface→View IP Config→TCP Socket Port

6.4.3 TCP Socket Communication

A TCP socket connection interface is provided as the communication medium for the Ethernet interface of the Model 336. A TCP socket connection, or simply “socket connection”, is a common connection protocol used by Ethernet devices. The Transmission Control Protocol (TCP) is commonly used for creating a communication channel between one program on one computer and one program on another computer, for example a web browser on a PC and a web server on the Internet. In the case of the Model 336, the protocol is used to create a communication channel between one program on one computer and the command line interface of the Model 336. TCP uses error correction and collision avoidance schemes that make it a very reliable form of Ethernet communication, but has drawbacks of having nondeterministic timing, and can encounter relatively large delays depending on network conditions. These delays can be on the order of seconds. Sockets use port numbers to identify sending and receiving endpoints on network devices. This allows for multiple separate communication links to exist on each device. *The port number used for TCP socket connections on the Model 336 is 7777.*



A maximum of two simultaneous socket connections can be made to the Model 336. Any attempts to open a new socket while two socket connections are already open on a Model 336 will fail.

6.4.4 Embedded Web Interface

The Model 336 provides a web interface via an embedded web server that runs on the instrument. Once the Model 336 is properly connected, and the IP parameters properly configured, the web interface can be opened using a web browser. The web interface should be accessible using any modern web browser, but has only been tested with Microsoft™ Internet Explorer version 6.0 and 7.0.

6.4.4.1 Connecting to the Web Interface

To connect to the web interface, type “http://” followed by the IP address assigned to the Model 336 that you are attempting to connect to. If connecting from a device on the same local network, and a hostname is properly assigned to the Model 336 via a naming service on the network (section 6.4.1.3), then the IP address can be replaced by the hostname. If connecting from a device not on the same local network, but on a network which is connected to the local network of the Model 336, and a hostname and a domain name are properly assigned, the IP address can be replaced by the hostname followed by the domain name, with a dot separator between them. For example if the hostname LSCI-3360001, and the domain name yourdomain.com were assigned via a naming service, then typing “http://LSCI-3360001.yourdomain.com” would open the home web page of the Model 336 embedded website.

6.4.4.2 Web Pages

Each web page contains detailed help information in the form of tool-tips. You can access these tool-tips by hovering the mouse pointer over the various help icons (show help icon image here) located throughout the embedded website.

Home Page: provides a summary of information specific to the Model 336.

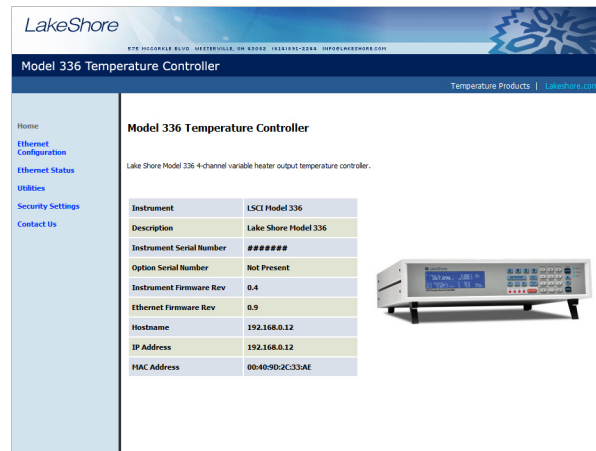

FIGURE 6-5 Model 336 home page

Ethernet Configuration Page: provides a means of reconfiguring the Ethernet configuration parameters of the Model 336.

FIGURE 6-6 Ethernet configuration page

Ethernet Status Page: provides status and statistics related to the current Ethernet connection.

Ethernet Status for Model 336 Temperature Controller	
Ethernet Uptime	56 minutes 25 seconds
Ethernet Speed	100 Mbps
Ethernet Duplex Mode	Full Duplex
Total Packets Received Since Power-on	491
Total Packets Sent Since Power-on	173

©2008 Lake Shore Cryotronics, Inc.

FIGURE 6-7 Ethernet status page

Utilities Page: provides links to launch the embedded curve handler application, the embedded Ethernet firmware updater, and the instrument configurator backup utilities

FIGURE 6-8 Utilities page

Security Settings: provides a means of changing the website security settings by allowing the user to enter a new username and password for the website, or to remove password protection from the website. The username and password parameters are available for viewing and editing from the front panel under the Modify IP Config submenu of the Interface menu.



Password protection only protects access to the embedded web pages and does not provide any kind of security for TCP Socket access (section 6.4.3).



The website username and password are available from the front panel menu, and therefore can easily be obtained by anyone with access to the Model 336 front panel.

Contact Us: provides information regarding how to contact representatives of Lake Shore Cryotronics, Inc.

6.5 Utilities

The utilities embedded on the Model 336 are written using the Java™ programming language. This theoretically allows the applications to run properly on many different platforms (Windows®, Mac®, Linux™, etc.), although the applications are only supported on Microsoft Windows® XP or Windows 7 and Vista®, and have been designed to work with the Java™ Runtime Environment (JRE) version 1.6. To download Java™ JRE please visit www.java.com.



Please note that without the proper JRE installed the utilities will not run properly.

The applications are launched from the Utilities web page using Java™ Web Start technology. This allows the application to run outside of the web browser in a stand-alone window. The application can only be launched using the link in the embedded web page, and cannot be permanently installed. When launching the application, multiple security warning messages may appear. These messages are meant to protect you from malicious software that can cause harm to, or compromise the security of, your computer or your data. The applications have been thoroughly tested and are considered by Lake Shore to be safe.



All software is imperfect and any software may be used by a malicious user for malicious purposes.

6.5.1 Embedded Curve Handler™

The Embedded Curve Handler™ utility is provided for uploading temperature curve files to the Model 336. The utility is also capable of reading curves from the Model 336 and writing them to a file for storage, or manipulation in a third party program. The Embedded Curve Handler™ supports standard Lake Shore temperature curve files in the “.340” file format, and the Microsoft Excel® “.XLS” (Excel® 97 - 2003) file format. Curve files are provided with calibrated sensors purchased from Lake Shore in the “.340” file format.

To read a temperature curve from a file: click **Read from File**. Select a properly formatted temperature curve (*.340 or *.XLS) file using the Open Browser dialog box. The curve will be loaded into the program and the curve points and graph will be displayed.

To read a temperature curve from the Model 336: click **Read from Instrument**. The Read Curve from Instrument dialog box appears. Select a curve from the drop-down box and click **OK**. The curve will be loaded into the program and the curve points and graph will be displayed.

Once a curve is loaded into the Embedded Curve Handler™ using either the Read from File or Read from Instrument buttons, the loaded curve can be stored either to a user curve location (21 to 59) in the Model 336, or to a file.

To store the curve to a user curve location in the Model 336: click **Write to Instrument**. The Write Curve to Instrument dialog box appears. Select a user curve location to write the loaded temperature curve to, and click **OK**.

To write the currently loaded curve to a file: click **Write to File**. A Save Browser dialog box appears. First use the Files of Type drop-down box to select the file format in which to save the curve. Then choose a directory and a file name, and click **Save**.

The .340 file format is an ASCII text file which can be read and altered using a standard ASCII text editor. Care must be taken when altering the .340 text files to ensure that all of the values are stored in the same position in the file as the original values, using the same number of digits. To alter curve files, it is recommended to use the .XLS file format, which can be altered using Microsoft Excel®. If using formulas to alter curves, you must copy the results of the formulas and paste them back into the original cells of the breakpoint values. The Embedded Curve Handler™ cannot interpret formulas in cells. In most versions of Excel®, this can be done by copying the formula results, then pasting them in the appropriate cells using the **Paste Special** command, and selecting **Paste Values**. Refer to the appropriate Microsoft Excel® documentation for details on the Paste Special operation.



The Embedded Curve Handler™ cannot read files in the Microsoft Excel® ".XLSX" (Excel® 2007 or newer) format. When saving files from Excel®, be sure to save them in the ".XLS" (Excel® 97 - 2003) format so that the file can be read using the Embedded Curve Handler™ utility.

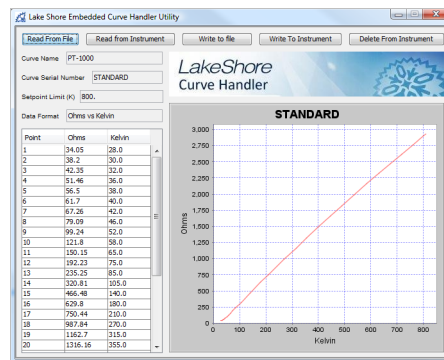

FIGURE 6-9 Screen shot of the Curve Handler

6.5.2 Ethernet Firmware Updater

The Ethernet Firmware Updater utility provides a means of updating the firmware that controls the Ethernet functionality of the Model 336. It also updates the embedded website and the Java™ utilities found on the Utilities web page. Please visit www.lakeshore.com for the latest firmware updates.

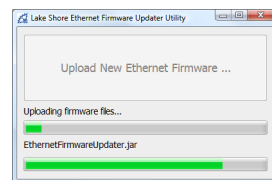

FIGURE 6-10 Screenshot of the Ethernet Firmware Updater



This utility only updates the Ethernet firmware and not the instrument firmware. Another utility is provided at the Lake Shore website (www.lakeshore.com) for updating the instrument firmware.

To use the Ethernet Firmware Updater utility: first ensure that your Java™ Runtime Environment is at version 1.6.0 or higher and then use this procedure to download the Ethernet firmware Updater utility.

1. Download the latest Model 336 Ethernet Firmware file from www.lakeshore.com.
2. Once the firmware files have been downloaded, connect to the embedded website (section 6.4.4), and navigate to the Utilities page.
3. Click **Launch Ethernet Firmware Updater**.
4. Accept any security warning messages that are presented (refer to section 6.5 for an explanation of these security warnings). The Ethernet Firmware Updater application window should now be open.
5. Click **Upload New Ethernet Firmware**, and a file browser window will open.
6. Navigate to the directory where the Model 336 Ethernet firmware is stored. Select the file and click **Open**.

At this point the application should check to see if the firmware you are attempting to update to is newer than what is already installed on the Model 336. If it is, then the firmware should immediately begin uploading, and the progress of the firmware update operation should be displayed using the two progress bars in the application window.

6.5.3 Instrument Configuration Backup Utility

The instrument configuration backup utility provides the means to export the current configuration of the Model 336 to a file, or to import a saved configuration from a file to the Model 336. The utility is useful in situations where the instrument is shared with users who require different configurations, or when the instrument is often moved between systems requiring different configurations. All instrument configuration settings are exported or imported by the utility except for the setpoint and heater range, network settings, and web login settings. These settings are ignored to prevent the outputs from unintentionally turning on and to prevent interrupting communication with the instrument.

To export the current configuration of the Model 336 to a file:

1. On the Utilities page in the Model 336 embedded website, click **Export config** (FIGURE 6-8).
2. In the Save File dialog box, select the location and file name to which you want to export the current instrument configuration. Click **Save**.

The utility will export the current configuration from the Model 336 and save it to the specified file.

To import a saved configuration from a file to the Model 336:

1. On the Utilities page in the Model 336 embedded website, click **Import config** (FIGURE 6-8).
2. In the Save File dialog box, select the file name from which you want to import the saved instrument configuration settings. Click **Open**.
3. Click **Yes, import settings** in the confirmation box that appears.

The utility will read the configuration from the specified file and import it to the Model 336.

6.5.4 Embedded Chart Recorder

The embedded chart recorder utility is provided to allow users to easily acquire and chart data from the Model 336. The chart recorder utility can simultaneously chart and log any combination of sensor readings, control setpoints, and heater output data from the Model 336. A basic user interface is also provided for changing control parameters on the fly while acquiring data, allowing many basic experiments to be performed without ever having to write any custom software. Log files are stored in the Microsoft Excel® .xls format for easy data manipulation. Free utilities are available online for converting .xls files to comma separated plain text files (.csv) if Microsoft Excel is not available.

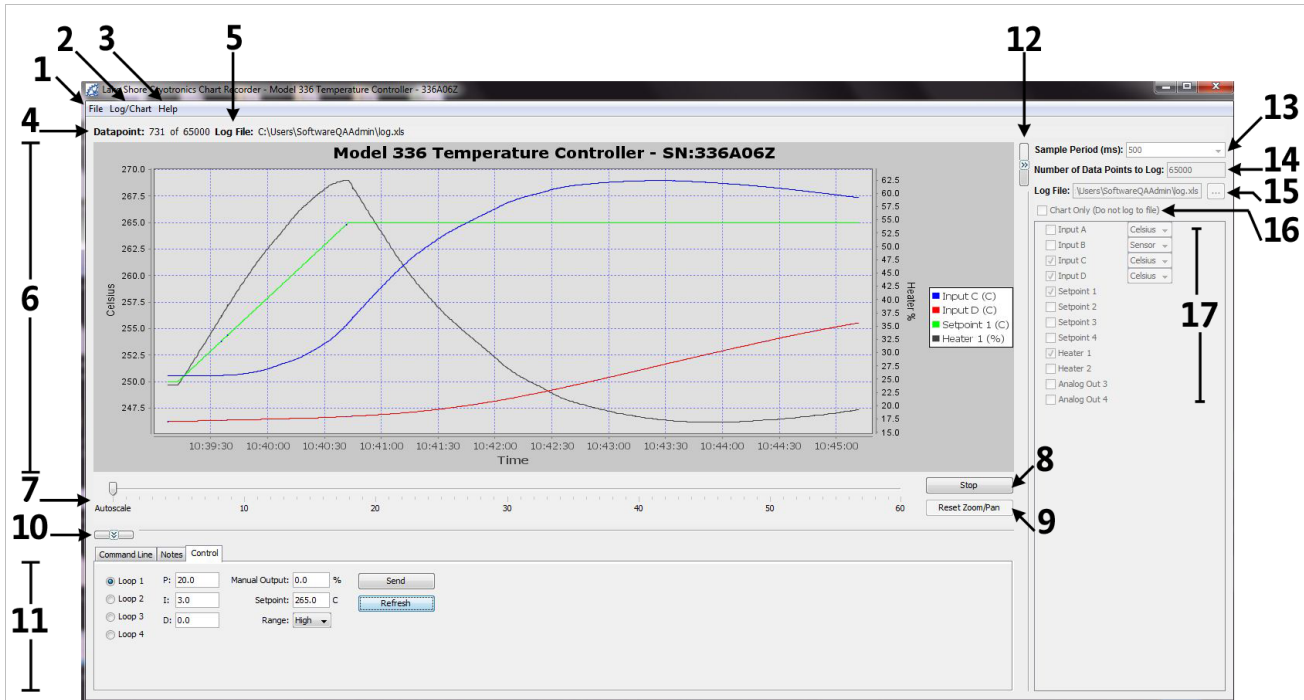

FIGURE 6-11 Embedded chart recorder interface

6.5.4.1 Configuration Panel

The configuration panel is located to the right of the chart and consists of items 12 through 17 in the screenshot above. It is used to configure the charting and logging functionality for the next data acquisition task. When Start is pressed, the parameters in the configuration panel are used to determine:

- **Sample period (13):** the rate at which to acquire readings from the instrument in milli-seconds.
- **Number of data points to log (14):** the number of data points to log if logging to a file.
- **Log file (15):** the path of the file to use for logging data, if logging to a file.
- **Chart only (16):** if selected, acquired data is only charted, and is not logged to a file.
- **Readings (17):** the readings, and units (where applicable) to take during data acquisition.

The configuration panel can be collapsed to increase the size of the chart. To collapse the configuration panel, simply click on **Collapse configuration panel (12)**. When collapsed, the same button becomes an **Expand Configuration Panel** button that can be used to restore the configuration panel on the form. When data acquisition is in progress, the configuration panel controls are disabled, but the current settings can still be seen.

6.5.4.2 Starting Data Acquisition

Once the parameters in the configuration panel are set as desired, simply click **Start** to begin data acquisition. If you are logging data to a file, the Number of Data Points to Log parameter is used to determine how many data points to take before terminating data acquisition. However, once data acquisition has begun, the **Start** button becomes a **Stop** button, and data acquisition can be terminated by pressing **Stop** button. If you are not logging to a file, data acquisition will continue until you press **Stop**.

6.5.4.3 Chart Functionality

By default, the chart (6), will autoscale in both the x and y-axis. The time scale slider (7) is provided to adjust the time scale window (x-axis scaling). When less than one hour of data has been logged, the slider will allow a time window between 1 and 60 min, in increments of 1 min. As the total elapsed time increases, the values on the time scale slider will also increase to allow time windows proportional to the elapsed time. A y-axis is added for each unique measurement unit of the selected readings. Each y-axis will be autoscaled, so if more than one reading is being taken in the same unit, the scale for the associated axis will be set such that the largest values of all readings are at the extremes. Data that is charted on the same axis, but that is far apart in magnitude, will result in low resolution for each data series.

Manual zooming of the chart can be achieved either by using the mouse wheel, or by clicking and dragging a box around the area of the chart to zoom to. Manual panning can be achieved by holding the Ctrl key, then clicking and dragging the chart. After manually zooming or panning, autoscaling in both axes is turned off and **Reset Zoom/Pan** becomes active. To return to autoscale mode, click **Reset Zoom/Pan**.

A screenshot of the currently displayed chart can be copied to the clipboard, saved in the PNG image format, or printed directly to a printer using the context menu that appears when right clicking on the chart. Other chart properties, such as colors and fonts can be customized through this context menu by clicking **Properties**. Note that changes to these chart properties are not saved when the application is closed, so the default values will be restored when reopening the chart recorder utility.

6.5.4.4 Utilities Panel

The utilities panel (11) provides added functionality to assist the user in various common tasks associated with user applications. Three tabs provide a means of selecting between the three utilities.

Command Line: provides command line access for sending commands and queries to the instrument. To send a command or query, type the command or query into the Command text box and click **Send**. Query responses are displayed in the Response box below. Click **Command Summary** to pull up the list of command line commands and queries supported by the instrument.

Notes: provides a means of adding notes to the log file while logging data. The note will be added to the notes column of the log file at the row associated with the most recently acquired data point. To add a note, simply add text to the text box next to the **Save Note** button, then click **Save Note**. Notes will be appended to the note history text box, along with a time stamp. If a note is saved while not currently logging data to a file, the note will only appear in the note history text box, and will only be available while the application is running.

Control: provides easy access to the control functions of the instrument. The P, I, D, Manual Output, Setpoint, and Heater Range settings can be configured here for each control loop on the instrument. The current configuration of the given control loop is displayed when the **Loop** radio button is selected. To update these parameters on the instrument, first select the loop to update by choosing a **Loop** radio button. Then update the values in the Control panel and click **Send**. Each control loop must be updated independently, so once the values in the Control panel are updated, click **Send** before clicking another **Loop** radio button.

The utilities panel can be collapsed to increase the size of the chart. To collapse the utilities panel, click **Collapse Utilities Panel** (10). When collapsed, the same button becomes an **Expand Utilities Panel** button that can be used to restore the utilities panel on the form.

6.5.4.5 Menu

The standard dropdown menu includes the following sections:

File (1):

- **Interface Configuration**—can be used to configure the remote interface connection to the instrument.
- **Exit**—closes the Chart Recorder application.

Log/Chart (2):

- **Configure Log/Chart**—simply expands the configuration panel if collapsed.
- **Hide Legend**—hides the legend in the chart to expand the data plot.

Help (3):

- **Getting Started**—launches a web page with basic chart recorder instructions.
- **About**—provides information about the application, including the software revision level.

6.5.4.6 Information

The information panel consists of the following two bits of information:

- **Datapoint (4)**—the current datapoint number. If logging data, this also shows the total number of data points to be taken in the current data acquisition (i.e. 522 of 1000).
- **Log File (5)**—the file path of the file that is currently being used to log data.

6.6 Command Summary

This section provides a listing of the interface commands. A summary of all the commands is provided in TABLE 6-6. All the commands are detailed in section 6.6.1, and are presented in alphabetical order.

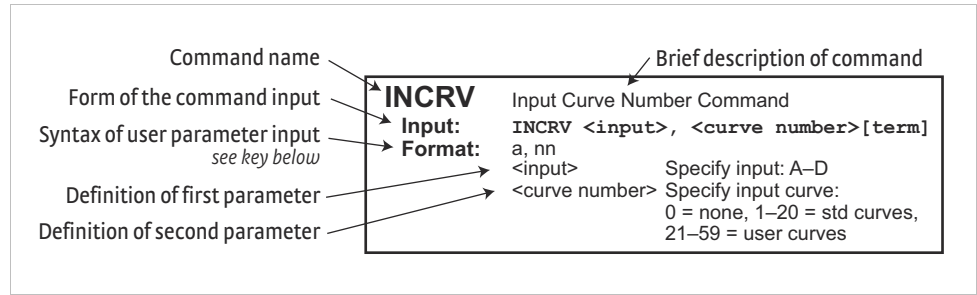

FIGURE 6-12 Sample command format

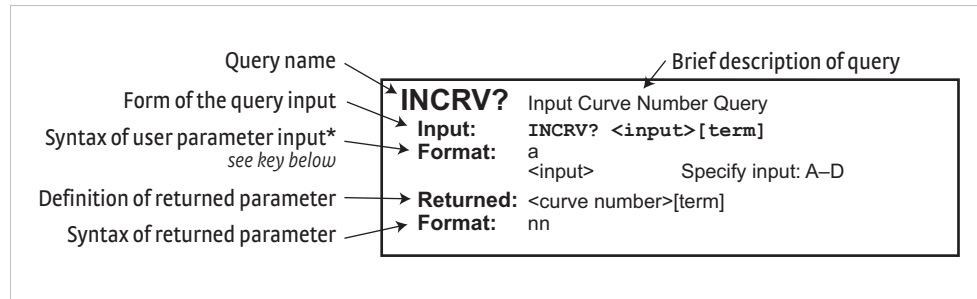

FIGURE 6-13 Sample query format

Command	Function	Page	Command	Function	Page
*CLS	Clear Interface Cmd	125	INTSEL?	Interface Select Query	135
*ESE	Event Status Enable Register Cmd	125	INTYPE	Input Type Parameter Cmd	136
*ESE?	Event Status Enable Register Query	125	INTYPE?	Input Type Parameter Query	136
*ESR?	Standard Event Status Register Query	125	KRDG?	Kelvin Reading Query	137
*IDN?	Identification Query	126	LEDS	Front Panel LEDS Cmd	137
*OPC	Operation Complete Cmd	126	LEDS?	Front Panel LEDS Query	137
*OPC?	Operation Complete Query	126	LOCK	Front Panel Keyboard Lock Cmd	137
*RST	Reset Instrument Cmd	126	LOCK?	Front Panel Keyboard Lock Query	137
*SRE	Service Request Enable Register Cmd	126	MDAT?	Minimum/Maximum Data Query	137
*SRE?	Service Request Enable Register Query	126	MNMXRST	Minimum and Maximum Function Reset Cmd	138
*STB?	Status Byte Query	127	MODE	Remote Interface Mode Cmd	138
*TST?	Self-Test Query	127	MODE?	Remote Interface Mode Query	138
*WAI	Wait-to-Continue Cmd	127	MOUT	Manual Output Cmd	138
ALARM	Input Alarm Parameter Cmd	127	MOUT?	Output Manual Heater Power (MHP) Output Query	138
ALARM?	Input Alarm Parameter Query	128	NET	Network Settings Cmd	138
ALARMST?	Input Alarm Status Query	128	NET?	Network Settings Query	139
ALMRST	Reset Alarm Status Cmd	128	NETID?	Network Configuration Query	139
ANALOG	Monitor Out Parameter Cmd	128	OPST?	Operational Status Query	139
ANALOG?	Monitor Out Parameter Query	129	OPSTE	Operational Status Enable Cmd	139
AOUT?	Analog Output Data Query	129	OPSTE?	Operational Status Enable Query	138
ATUNE	Autotune Cmd	129	OPSTR?	Operational Status Register Query	140
BRIGT	Display Contrast Cmd	129	OUTMODE	Output Mode Cmd	140
BRIGT?	Display Contrast Query	129	OUTMODE?	Output Mode Query	140
CRDG?	Celsius Reading Query	130	PID	Control Loop PID Values Cmd	140
CRVDEL	Curve Delete Cmd	130	PID?	Control Loop PID Values Query	141
CRVHDR	Curve Header Cmd	130	RAMP	Control Setpoint Ramp Parameter Cmd	141
CRVHDR?	Curve Header Query	130	RAMP?	Control Setpoint Ramp Parameter Query	141
CRVPT	Curve Data Point Cmd	131	RAMPST?	Control Setpoint Ramp Status Query	141
CRVPT?	Curve Data Point Query	131	RANGE	Heater Range Cmd	141
DFLT	Factory Defaults Cmd	131	RANGE?	Heater Range Query	141
DIOCUR	Diode Excitation Current Parameter Cmd	131	RDGST?	Input Reading Status Query	142
DIOCUR?	Diode Excitation Current Parameter Query	131	RELAY	Relay Control Parameter Cmd	142
DISPFLD	Custom ModeDisplay Field Cmd	132	RELAY?	Relay Control Parameter Query	142
DISPFLD?	Custom Mode Display Field Query	132	RELAYST?	Relay Status Query	142
DISPLAY	Display Setup Cmd	132	SCAL	Generate SoftCal Curve Cmd	143
DISPLAY?	Display Setup Query	132	SETP	Control Setpoint Cmd	143
FILTER	Input Filter Parameter Cmd	133	SETP?	Control Setpoint Query	143
FILTER?	Input Filter Parameter Query	133	SRDG?	Sensor Units Input Reading Query	143
HTR?	Heater Output Query	133	TEMP?	Thermocouple Junction Temperature Query	144
HTRSET	Heater Setup Cmd	133	TLIMIT	Temperature Limit Cmd	144
HTRSET?	Heater Setup Query	134	TLIMIT?	Temperature Limit Query	144
HTRST?	Heater Status Query	134	TUNEST?	Control Tuning Status Query	144
IEEE	IEEE-488 Parameter Cmd	134	WARMUP	Warmup Supply Parameter Cmd	145
IEEE?	IEEE-488 Interface Parameter Query	134	WARMUP?	Warmup Supply Parameter Query	145
INCRV	Input Curve Number Cmd	134	WEBLOG	Website Login Parameters	145
INCRV?	Input Curve Number Query	134	WEBLOG?	Website Login Parameter Query	145
INNAME	Sensor Input Name Cmd	135	ZONE	Control Loop Zone Table Parameter Cmd	146
INNAME?	Sensor Input Name Query	135	ZONE?	Output Zone Table Parameter Query	146
INTSEL	Interface Select Cmd	135			

TABLE 6-6 Command summary

6.6.1 Interface Commands

This section lists the interface commands in alphabetical order.

*	Begins common interface command
?	Required to identify queries
s[n]	String of alphanumeric characters with length “n.” Send these strings using surrounding quotes. Quotes enable characters such as commas and spaces to be used without the instrument interpreting them as delimiters.
nn...	String of number characters that may include a decimal point.
dd	Dotted decimal format, common with IP addresses. Always contains 4 dot separated 3-digit decimal numbers, such as 192.168.000.012.
[term]	Terminator characters
<...>	Indicated a parameter field, many are command specific.
<state>	Parameter field with only On/Off or Enable/Disable states.
<value>	Floating point values have varying resolution depending on the type of command or query issued.

TABLE 6-7 Interface commands key

*CLS

Input
Remarks

Clear Interface Command

***CLS [term]**

Clears the bits in the Status Byte Register, Standard Event Status Register, and Operation Event Register, and terminates all pending operations. Clears the interface, but not the controller. The related controller command is *RST.

*ESE

Input
Format
Remarks

Event Status Enable Register Command

***ESE <bit weighting> [term]**

nnn

Each bit is assigned a bit weighting and represents the enable/disable mask of the corresponding event flag bit in the Standard Event Status Register. To enable an event flag bit, send the command *ESE with the sum of the bit weighting for each desired bit. Refer to section 6.2.5 for a list of event flags.

Example

To enable event flags 0, 4, and 7, send the command *ESE 145[term]. 145 is the sum of the bit weighting for each bit.

Bit	Bit Weighting	Event Name
0	1	OPC
2	4	QXE
4	16	EXE
5	32	CME
7	128	PON
Total:	181	

*ESE?

Input
Returned
Format

Event Status Enable Register Query

***ESE? [term]**

<bit weighting>[term]

nnn (Refer to section 6.2.5 for a list of event flags)

*ESR?

Input
Returned
Format
Remarks

Standard Event Status Register Query

***ESR? [term]**

<bit weighting>

nnn

The integer returned represents the sum of the bit weighting of the event flag bits in the Standard Event Status Register. Refer to section 6.2.5 for a list of event flags.

*IDN?	Identification Query															
Input	*IDN? [term]															
Returned	<manufacturer>,<model>,<instrument serial><option serial>,<firmware version>[term]															
Format	s[4],s[8],s[7]/s[7],n.n <manufacturer> Manufacturer ID <model> Instrument model number <instrument serial> Instrument serial number <option card serial> Option card serial number <firmware version> Instrument firmware version															
Example	LSCI,MODEL336,1234567/1234567,1.0															
<hr/>																
*OPC	Operation Complete Command															
Input	*OPC [term]															
Remarks	Generates an Operation Complete event in the Event Status Register upon completion of all pending selected device operations. Send it as the last command in a command string.															
<hr/>																
*OPC?	Operation Complete Query															
	*OPC? [term]															
Returned	1[term]															
Remarks	Places a 1 in the controller output queue upon completion of all pending selected device operations. Send as the last command in a command string. Not the same as *OPC.															
<hr/>																
*RST	Reset Instrument Command															
Input	*RST [term]															
Remarks	Sets controller parameters to power-up settings.															
<hr/>																
*SRE	Service Request Enable Register Command															
Input	*SRE <bit weighting> [term]															
Format	nnn															
Remarks	Each bit has a bit weighting and represents the enable/disable mask of the corresponding status flag bit in the Status Byte Register. To enable a status flag bit, send the command *SRE with the sum of the bit weighting for each desired bit. Refer to section 6.2.6 for a list of status flags.															
Example	To enable status flags 4, 5, and 7, send the command *SRE 208[term]. 208 is the sum of the bit weighting for each bit.															
	<table border="0"> <thead> <tr> <th>Bit</th> <th>Bit Weighting</th> <th>Event Name</th> </tr> </thead> <tbody> <tr> <td>4</td> <td>16</td> <td>MAV</td> </tr> <tr> <td>5</td> <td>64</td> <td>ESB</td> </tr> <tr> <td>7</td> <td>128</td> <td>OSB</td> </tr> <tr> <td>Total:</td> <td>208</td> <td></td> </tr> </tbody> </table>	Bit	Bit Weighting	Event Name	4	16	MAV	5	64	ESB	7	128	OSB	Total:	208	
Bit	Bit Weighting	Event Name														
4	16	MAV														
5	64	ESB														
7	128	OSB														
Total:	208															
<hr/>																
*SRE?	Service Request Enable Register Query															
Input	*SRE? [term]															
Returned	<bit weighting>[term]															
Format	nnn (Refer to section 6.2.6 for a list of status flags)															

*STB?	Status Byte Query
Input	*STB? [term]
Returned	<bit weighting>[term]
Format	nnn
Remarks	Acts like a serial poll, but does not reset the register to all zeros. The integer returned represents the sum of the bit weighting of the status flag bits that are set in the Status Byte Register. Refer to section 6.2.6 for a list of status flags.

*TST?	Self-Test Query
Input	*TST? [term]
Returned	<status>[term]
Format	n
	<status> 0 = no errors found, 1 = errors found
Remarks	The Model 336 reports status based on test done at power up.

*WAI	Wait-to-Continue Command
Input	*WAI [term]
Remarks	Causes the IEEE-488 interface to hold off until all pending operations have been completed. This is the same function as the *OPC command, except that it does not set the Operation Complete event bit in the Event Status Register.

ALARM	Input Alarm Parameter Command
Input	ALARM <input>, <off/on>, <high value>, <low value>, <deadband>, <latch enable>, <audible>, <visible> [term]
Format	a,n,±nnnnnn,±nnnnnn,+nnnnnn,n,n,n <input> Specifies which input to configure: A - D (D1–D5 for 3062 option). <off/on> Determines whether the instrument checks the alarm for this input, where 0 = off and 1 = on. <high setpoint> Sets the value the source is checked against to activate the high alarm. <low setpoint> Sets the value the source is checked against to activate low alarm. <deadband> Sets the value that the source must change outside of an alarm condition to deactivate an unlatched alarm. <latch enable> Specifies a latched alarm (remains active after alarm condition correction) where 0 = off (no latch) and 1 = on. <audible> Specifies if the internal speaker will beep when an alarm condition occurs. Valid entries: 0 = off, 1 = on. <visible> Specifies if the Alarm LED on the instrument front panel will blink when an alarm condition occurs. Valid entries: 0 = off, 1 = on
Remarks	Configures the alarm parameters for an input.
Example	ALARM A,0[term]—turns off alarm checking for Input A. ALARM B,1,270.0,0,0,1,1,1[term]—turns on alarm checking for input B, activates high alarm if kelvin reading is over 270, and latches the alarm when kelvin reading falls below 270. Alarm condition will cause instrument to beep and the front panel Alarm LED to blink.

ALARM?	Input Alarm Parameter Query
Input	ALARM? <input> [term]
Format	a <input> A-D
Returned	<off/on>,<high value>,<low value>,<deadband>,<latch enable>,<audible>,<visible> [term]
Format	n,±nnnnnn,±nnnnnn,+nnnnnn,n,n,n (refer to command for description)
ALARMST?	Input Alarm Status Query
Input	ALARMST? <input> [term]
Format	a <input> A - D (D1-D5 for 3062 option)
Returned	<high state>,<low state>[term]
Format	n,n <high state> 0 = Off, 1 = On <low state> 0 = Off, 1 = On
ALMRST	Reset Alarm Status Command
Input	ALMRST [term]
Remarks	Clears both the high and low status of all alarms, including latching alarms.
ANALOG	Monitor Out Parameter Command
Input	ANALOG <output>,<input>,<units>,<high value>,<low value>,<polarity> [term]
Format	n,n,n,±nnnnn,±nnnnn,n <output> Unpowered analog output to configure: 3 or 4 <input> Specifies which input to monitor. 0 = none, 1 = Input A, 2 = Input B, 3 = Input C, 4 = Input D (5 = Input D2, 6 = Input D3, 7 = Input D4, 8 = Input D5 for 3062 option) <units> Specifies the units on which to base the output voltage: 1 = kelvin, 2 = Celsius, 3 = sensor units <high value> If output mode is Monitor Out, this parameter represents the data at which the Monitor Out reaches +100% output. Entered in the units designated by the <units> parameter. Refer to OUTMODE command. <low value> If output mode is Monitor Out, this parameter represents the data at which the analog output reaches -100% output if bipolar, or 0% output if positive only. Entered in the units designated by the <units> parameter. <polarity> Specifies output voltage is 0 = unipolar (positive output only) or 1 = bipolar (positive or negative output)
Example	ANALOG 4,1,1,100.0,0.0,0 [term]—sets output 4 to monitor Input A kelvin reading with 100.0 K at +100% output (+10.0 V) and 0.0 K at 0% output (0.0 V).
Remarks	Use the OUTMODE command to set the output mode to Monitor Out. The <input> parameter in the ANALOG command is the same as the <input> parameter in the OUTMODE command. It is included in the ANALOG command for backward compatibility with previous Lake Shore temperature monitors and controllers. The ANALOG command name is also named as such for backward compatibility.

ANALOG? Monitor Out Parameter Query

Input ANALOG? <output> [term]
Format n

<output> Specifies which unpowered analog output to query the Monitor Out parameters for: 3 or 4.

Returned <input>,<units>,<high value>,<low value>,<polarity>[term]
Format n,n,±nnnnn,±nnnnn,n (refer to command for definition)

AOUT? Analog Output Data Query

Input AOUT? <output> [term]
Format n

<output> Specifies which unpowered analog output to query: 3 or 4.

Returned <output percentage>[term]
Format ±nnn.n

Remarks Returns the output percentage of the unpowered analog output.

ATUNE Autotune Command

Input ATUNE <output>, <mode>, [term]
Format n,n

<output> Specifies the output associated with the loop to be Autotuned: 1 – 4.

<mode> Specifies the Autotune mode. Valid entries: 0 = P Only, 1 = P and I, 2 = P, I, and D.

Example ATUNE 2,1 [term]—initiates Autotuning of control loop associated with output 2, in P and I mode.

Remarks If initial conditions required to Autotune the specified loop are not met, an Autotune initialization error will occur and the Autotune process will not be performed. The TUNEST? query can be used to check if an Autotune error occurred.

BRIGT Display Contrast Command

Input BRIGT <contrast value> [term]
Format nn

<contrast value> 1–32

Remarks Sets the display contrast for the front panel LCD.

BRIGT? Display Contrast Query

Input BRIGT? [term]
Returned <contrast value>[term]
Format nn (refer to command for description)

<hr/>	
CRDG?	Celsius Reading Query
Input	CRDG? <input> [term]
Format	a <input> Specifies input to query: A-D (D1–D5 for 3062 option)
Returned	<temp value> Or if all inputs are queried: <A value>,<B value>,<C value>,<D value>
Format	±nnnnnnn[term] Or if all inputs are queried: ±nnnnn,±nnnnn,±nnnnn,±nnnnn[term]
Remarks	Returns the Celsius reading for a single input or all inputs. <input> specifies which input(s) to query. 0 = all inputs. Also see the RDGST? command.
<hr/>	
CRVDEL	Curve Delete Command
Input	CRVDEL <curve> [term]
Format	nn <curve> Specifies a user curve to delete. Valid entries: 21–59.
Example	CRVDEL 21[term] —deletes User Curve 21.
<hr/>	
CRVHDR	Curve Header Command
Input	CRVHDR <curve>, <name>, <SN>, <format>, <limit value>, <coefficient> [term]
Format	nn,s[15],s[10],n,+nnn.nnn,n <curve> Specifies which curve to configure. Valid entries: 21–59. <name> Specifies curve name. Limited to 15 characters. <SN> Specifies the curve serial number. Limited to 10 characters. <format> Specifies the curve data format. Valid entries: 1 = mV/K, 2 = V/K, 3 = Ω/K, 4 = log Ω/K. <limit value> Specifies the curve temperature limit in kelvin. <coefficient> Specifies the curves temperature coefficient. Valid entries: 1 = negative, 2 = positive.
Remarks	Configures the user curve header. The coefficient parameter will be calculated automatically based on the first 2 curve datapoints. It is included as a parameter for compatibility with the CRVHDR? query.
Example	CRVHDR 21,DT-470,00011134,2,325.0,1[term] —configures User Curve 21 with a name of DT-470, serial number of 00011134, data format of volts versus kelvin, upper temperature limit of 325 K, and negative coefficient.
<hr/>	
CRVHDR?	Curve Header Query
Input	CRVHDR? <curve> [term]
Format	nn <curve> Valid entries: 1–59.
Returned	<name>,<SN>,<format>,<limit value>,<coefficient>[term]
Format	s[15],s[10],n,+nnn.nnn,n (refer to command for description)

CRVPT Curve Data Point Command

Input Format	CRVPT <curve>,<index>,<units value>,<temp value> [term] nn,nnn,±nnnnnn,+nnnnnn
	<curve> Specifies which curve to configure. Valid entries: 21–59. <index> Specifies the points index in the curve. Valid entries: 1–200. <units value> Specifies sensor units for this point to 6 digits. <temp value> Specifies the corresponding temperature in kelvin for this point to 6 digits.
Remarks	Configures a user curve data point.
Example	CRVPT 21,2,0.10191,470.000,N[term] —sets User Curve 21 second data point to 0.10191 sensor units and 470.000 K.

CRVPT? Curve Data Point Query

Input Format	CRVPT? <curve>,<index> [term] nn,nnn
	<curve> Specifies which curve to query: 1–59. <index> Specifies the points index in the curve: 1–200.
Returned Format	<units value>,<temp value>[term] ±nnnnnn,+nnnnnn (refer to command for description)
Remarks	Returns a standard or user curve data point.

DFLT Factory Defaults Command

Input Format	DFLT 99 [term]
Remarks	Sets all configuration values to factory defaults and resets the instrument. The “99” is included to prevent accidentally setting the unit to defaults.

DIOCUR Diode Excitation Current Parameter Command

Input Format	DIOCUR <input>,<excitation> [term] a,n
	<input> Specifies which input to configure: A–D. <excitation> Specifies the Diode excitation current: 0 = 10 μ A, 1 = 1 mA.
Remarks	The 10 μ A excitation current is the only calibrated excitation current, and is used in almost all applications. Therefore the Model 336 will default the 10 μ A current setting any time the input sensor type is changed in order to prevent an accidental change. If using a current that is not 10 μ A, the input sensor type must first be configured to Diode (INTYPE command). If the sensor type is not set to Diode when the DIOCUR command is sent, the command will be ignored.

DIOCUR? Diode Excitation Current Parameter Query

Input Format	DIOCUR? <input> [term] a
	<input> A–D
Returned Format	<excitation> [term] n (refer to command for description)

DISPFLD Custom Mode Display Field CommandInput
Format**DISPFLD** <field>, <input>, <units> [term]

n,n,n

<field>

Specifies field (display location) to configure: 1–8.

<input>

Specifies item to display in the field: 0 = None, 1 = Input A, 2 = Input B, 3 = Input C, 4 = Input D (5 = Input D2, 6 = Input D3, 7 = Input D4, 8 = Input D5 for 3062 option)

= Input

<units>

Valid entries: 1 = kelvin, 2 = Celsius, 3 = sensor units, 4 = minimum data, and 5 = maximum data.

Example

DISPFLD 2,1,1[term]—displays kelvin reading for Input A in display field 2 when display mode is set to Custom.

Remarks

This command only applies to the readings displayed in the Custom display mode. All other display modes have predefined readings in predefined locations, and will use the Preferred Units parameter to determine which units to display for each sensor input. Refer to section 4.3 for details on display setup

DISPFLD? Custom Mode Display Field QueryInput
Format**DISPFLD?** <field> [term]

n

<field>

Specifies field (display location) to query: 1–8.

Returned

<input>,<units>[term]

Format

n,n (refer to command for description)

DISPLAY Display Setup CommandInput
Format**DISPLAY** <mode>, <num fields>, <output source> [term]

n,n,n

<mode>

Specifies display mode: 0 = Input A, 1 = Input B, 2 = Input C, 3 = Input D, 4 = Custom, 5 = Four Loop, (6 = All Inputs, 7 = Input D2, 8 = Input D3, 9 = Input D4, 10 = Input D5 for 3062 option)

<num fields>

When mode is set to Custom, specifies number of fields (display locations) to display: 0 = 2 large, 1 = 4 large, 2 = 8 small. When mode is set to All Inputs, specifies size of readings: 0 = small with input names, 1 = large without input names

<displayed output>

Specifies which output, and associated loop information, to display in the bottom half of the custom display screen: 1 = Output 1, 2 = Output 2, 3 = Output 3, 4 = Output 4

Example

DISPLAY 4,0,1[term]—set display mode to Custom with 2 large display fields, and set custom output display source to Output 1.

Remarks

The <num fields> and <displayed output> commands are ignored in all display modes except for Custom.

DISPLAY? Display Setup QueryInput
Returned
Format**DISPLAY?** [term]

<mode>,<num fields>,<output source>[term]

n,n,n (refer to command for description)

FILTER Input Filter Parameter Command

Input Format	FILTER <input>, <off/on>, <points>, <window> [term] a,n,nn,nn
	<input> Specifies input to configure: A–D (D1–D5 for 3062 option).
	<off/on> Specifies whether the filter function is 0 = Off or 1 = On.
	<points> Specifies how many data points the filtering function uses. Valid range = 2 to 64.
	<window> Specifies what percent of full scale reading limits the filtering function. Reading changes greater than this percentage reset the filter. Valid range = 1 to 10%.
Example	FILTER B,1,10,2[term] —filter input B data through 10 readings with 2% of full scale window.

FILTER? Input Filter Parameter Query

Input Format	FILTER? <input> [term] a
	<input> Specifies input to query: A–D (D1–D5 for 3062 option).
Returned Format	<off/on >, <points>, <window> [term] n,nn,nn (refer to command for description)

HTR? Heater Output Query

Input Format	HTR? <output> [term] n
	<output> Heater output to query: 1 = Output 1, 2 = Output 2
Returned Format	<heater value> [term] +nnn.n
	<heater value> Heater output in percent (%).
Remarks	HTR? is for the Heater Outputs, 1 and 2, only. Use AOUT? for Outputs 3 and 4.

HTRSET Heater Setup Command

Input Format	HTRSET <output>, <heater resistance>, <max current>, <max user current>, <current/power> [term]
Format	n,n,n,+n.nnn,n
	<output> Specifies which heater output to configure: 1 or 2.
	<htr resistance> Heater Resistance Setting: 1 = 25 Ω , 2 = 50 Ω .
	<max current> Specifies the maximum heater output current: 0 = User Specified, 1 = 0.707 A, 2 = 1 A, 3 = 1.141 A, 4 = 2 A
	<max user current> Specifies the maximum heater output current if max current is set to User Specified.
	<current/power> Specifies whether the heater output displays in current or power. Valid entries: 1 = current, 2 = power.
Example	HTRSET 1,1,2,0,1[term] —Heater output 1 will use the 25 Ω heater setting, has a maximum current of 1 A, the maximum user current is set to 0 A because it is not going to be used since a discrete value has been chosen, and the heater output will be displayed in units of current.
Remarks	Max current will be limited to 1.414 A on output 2 if the heater resistance is set to 25 Ω , and will be limited to 1 A on both outputs 1 and 2 if the heater resistance is set to 50 Ω .

HTRSET?	Heater Setup Query
Input	HTRSET? <output> [term]
Format	n
Returned	<output> Specifies which heater output to query: 1 or 2.
Format	<htr resistance>,<max current>,<max user current>,<current/power>[term] n,n,+n.nnn,n
<hr/>	
HTRST?	Heater Status Query
Input	HTRST? <output> [term]
Format	n
Returned	<output> Specifies which heater output to query: 1 or 2.
Format	<error code>[term]
Remarks	n <error code> Heater error code: 0 = no error, 1 = heater open load, 2 = heater short. Error condition is cleared upon querying the heater status, which will also clear the front panel error message
<hr/>	
IEEE	IEEE-488 Interface Parameter Command
Input	IEEE <address> [term]
Format	nn
Example	<address> Specifies the IEEE address: 1–30. (Address 0 and 31 are reserved.) IEEE 4[term] —after receipt of the current terminator, the instrument responds to address 4.
<hr/>	
IEEE?	IEEE-488 Interface Parameter Query
Input	IEEE? [term]
Returned	<address>[term]
Format	nn (refer to command for description)
<hr/>	
INCRV	Input Curve Number Command
Input	INCRV <input>,<curve number> [term]
Format	a,nn
Returned	<input> Specifies which input to configure: A–D (D1–D5 for 3062 option).
Remarks	<curve number> Specifies which curve the input uses. If specified curve type does not match the configured input type, the curve number defaults to 0. Valid entries: 0 = none, 1–20 = standard curves, 21–59 = user curves.
Example	Specifies the curve an input uses for temperature conversion. INCRV A,23[term] —Input A uses User Curve 23 for temperature conversion.
<hr/>	
INCRV?	Input Curve Number Query
Input	INCRV? <input> [term]
Format	a
Returned	<input> Specifies which input to query: A–D (D1–D5 for 3062 option).
Format	<curve number>[term] nn (refer to command for description)

INNAME **Sensor Input Name Command**

Input **INNAME** <input>, <name> [term]
Format a,s[15]

<input> Specifies input to configure: A–D (D1–D5 for 3062 option).
<name> Specifies the name to associate with the sensor input.

Example **INNAME A, “Sample Space”[term]**—the string “Sample Space” will appear on the front panel display when possible to identify the sensor information being displayed.

Remarks Be sure to use quotes when sending strings, otherwise characters such as spaces, and other non alpha-numeric characters, will be interpreted as a delimiter and the full string will not be accepted. It is not recommended to use commas or semi-colons in sensor input names as these characters are used as delimiters for query responses.

INNAME? **Sensor Input Name Query**

Input **INNAME?** <input> [term]
Format a

<input> Specifies input to query: A–D (D1–D5 for 3062 option).

Returned <name>[term]
Format s[15] (refer to command for description)

INTSEL **Interface Select Command**

Input **INTSEL** <interface> [term]
Format n

<interface> Specifies the remote interface to enable: 0 = USB, 1 = Ethernet, 2 = IEEE-488.

Remarks The Ethernet interface will attempt to configure itself based on the current configuration parameters, which can be set using the NET command. Configuring the Ethernet interface parameters prior to enabling the interface is recommended.

INTSEL? **Interface Select Query**

Input **INTSEL?** [term]
Returned <interface>[term]
Format n (refer to command for description)

INTYPE Input Type Parameter Command

Input INTYPE <input>, <sensor type>, <autorange>, <range>, <compensation>, <units> [term]

Format a,n,n,n,n,n

<input> Specifies input to configure: A–D (D1–D5 for 3062 option)

<sensor type> Specifies input sensor type:

0 = Disabled

1 = Diode

2 = Platinum RTD

3 = NTC RTD

4 = Thermocouple (3060 option only)

5 = Capacitance (3061 option only)

<autorange> Specifies autoranging: 0 = off and 1 = on.

<range> Specifies input range when autorange is off:

Diode	0 = 2.5 V
	1 = 10 V
PTC RTD	0 = 10 Ω
	1 = 30 Ω
	2 = 100 Ω
	3 = 300 Ω
	4 = 1 k Ω
	5 = 3 k Ω
NTC RTD	6 = 10 k Ω
	0 = 10 Ω
	1 = 30 Ω
	2 = 100 Ω
	3 = 300 Ω
	4 = 1 k Ω
	5 = 3 k Ω
	6 = 10 k Ω
7 = 30 k Ω	
8 = 100 k Ω	
Thermocouple	0 = 50 mV

TABLE 6-8 *Input range*

<compensation> Specifies input compensation where 0 = off and 1 = on. Reversal for thermal EMF compensation if input is resistive, room compensation if input is thermocouple. Always 0 if input is a diode.

<units> Specifies the preferred units parameter for sensor readings and for the control setpoint: 1 = kelvin, 2 = Celsius, 3 = Sensor

Example INTYPE A,2,1,0,1,1[term]—sets Input A sensor type to Platinum RTD, autorange on, thermal compensation on, and preferred units to kelvin.

Remarks The <autorange> and <range> parameters do not apply to Thermocouple sensor type, and the <autorange> and <compensation> parameters do not apply to Diode sensor type. When configuring diode or thermocouple sensor types, these parameters must be included, but are ignored. A setting of 0 for each is recommended in this case.

INTYPE? Input Type Parameter Query

Input INTYPE? <input> [term]

Format a

<input> Specifies input to query: A - D (D1–D5 for 3062 option).

<sensor type>, <autorange>, <range>, <compensation>, <units> [term]

Returned Format n,n,n,n,n (refer to command for description)

Remarks If autorange is on, the returned range parameter is the currently auto-selected range.

KRDG?	Kelvin Reading Query
Input	KRDG? <input> [term]
Format	a <input> Specifies input to query: A-D (D1–D5 for 3062 option)
Returned	<temp value> Or if all inputs are queried: <A value>,<B value>,<C value>,<D value>
Format	+nnnnnnn[term] Or if all inputs are queried: +nnnnn,+nnnnn,+nnnnn,+nnnnn[term]
Remarks	Returns the Kelvin reading for a single input or all inputs. <input> specifies which input(s) to query. 0 = all inputs. Also see the RDGST? command.
<hr/>	
LEDS	Front Panel LEDES Command
Input	LEDS <off/on> [term]
Format	n <off/on> 0 = LEDs Off, 1 = LEDs On
Remarks	If set to 0, front panel LEDs will not be functional. Function can be used when display brightness is a problem.
Example	LED 0[term] —turns all front panel LED functionality off.
<hr/>	
LEDS?	Front Panel LEDES Query
Input	LEDS? [term]
Returned	<off/on> [term]
Format	n (refer to command for description)
<hr/>	
LOCK	Front Panel Keyboard Lock Command
Input	LOCK <state>,<code> [term]
Format	n,nnn <state> 0 = Unlocked, 1 = Locked <code> Specifies lock-out code. Valid entries are 000–999.
Remarks	Locks out all front panel entries except pressing the All Off key to immediately turn off all heater outputs. Refer to section 4.7.
Example	LOCK 1,123[term] —enables keypad lock and sets the code to 123.
<hr/>	
LOCK?	Front Panel Keyboard Lock Query
Input	LOCK? [term]
Returned	<state>,<code>[term]
Format	n,nnn (refer to command for description)
<hr/>	
MDAT?	Minimum/Maximum Data Query
Input	MDAT? <input> [term]
Format	a <input> Specifies which input to query: A–D (D1–D5 for 3062 option).
Returned	<min value>,<max value>[term]
Format	±nnnnnn,±nnnnnn
Remarks	Returns the minimum and maximum input data. Also see the RDGST? command.

MNMXRST	Minimum and Maximum Function Reset Command
Input	MNMXRST [term]
Remarks	Resets the minimum and maximum data for all inputs.
MODE	Remote Interface Mode Command
Input	MODE <mode> [term]
Format	n
	<mode> 0 = local, 1 = remote, 2 = remote with local lockout.
Example	MODE 2 [term]—places the Model 336 into remote mode with local lockout.
MODE?	Remote Interface Mode Query
Input	MODE? [term]
Returned	<mode>[term]
Format	n (refer to command for description)
MOUT	Manual Output Command
Input	MOUT <output>, <value> [term]
Format	n, +nnnnn[term]
	<output> Specifies output to configure: 1–4.
	<value> Specifies value for manual output.
Example	MOUT 1,22.45 [term]—Output 1 manual output is 22.45%.
Remarks	Manual output only applies to outputs in Closed Loop PID, Zone, or Open Loop modes.
MOUT?	Manual Output Query
Input	MOUT? <output> [term]
Format	n
	<output> Specifies which output to query: 1 - 4.
Returned	<value>
Format	+ nnnnn[term] (refer to command for description)
NET	Network Settings Command
Input	NET <DHCP>, <AUTO IP>, <IP>, <Sub Mask>, <Gateway>, <Pri DNS>, <Sec DNS>, <Pref Host>, <Pref Domain>, <Description> [term]
Format	n,n,dd,dd,dd,dd,s[15],s[64],s[32],
	<DHCP> 0 = DHCP off, 1=DHCP on.
	<AUTO IP> 0 = Dynamically configured link-local addressing (Auto IP) off, 1 = On
	<IP> IP address for static configuration.
	<Sub Mask> Subnet mask for static configuration.
	<Gateway> Gateway address for static configuration.
	<Pri DNS> Primary DNS address for static configuration.
	<Sec DNS> Secondary DNS address for static configuration.
	<Pref Host> Preferred Hostname (15 character maximum)
	<Pref Domain> Preferred Domain name (64 character maximum)
	<Description> Instrument description (32 character maximum)

NET?	Network Settings Query
Input	NET? [term]
Returned	<DHCP>,<AUTO IP>,<IP>,<Sub Mask>,<Gateway>,<Pri DNS>,<Sec DNS>,<Pref Host>,<Pref Domain>,<Description>[term]
Format	n,n,dd,dd,dd,dd,dd,s[15],s[64],s[32] (refer to command for description)
<hr/>	
NETID?	Network Configuration Query
Input	NETID? [term]
Returned	<lan status>,<IP>,<sub mask>,<gateway>,<pri DNS>,<sec DNS>,<mac addr>,<actual hostname>,<actual domain>[term]
Format	n,dd,dd,dd,dd,dd,hh:hh:hh:hh:hh:s[15],s[32]
	<lan status> Current status of Ethernet connection: 0 = Connected Using Static IP, 1 = Connected Using DHCP, 2 = Connected Using Auto IP, 3 = Address Not Acquired Error, 4 = Duplicate Initial IP Address Error, 5 = Duplicate Ongoing IP Address Error, 6 = Cable Unplugged, 7 = Module Error, 8 = Acquiring Address, 9 = Ethernet Disabled. Refer to section 6.4.2.1 for details on lan status.
	<IP> Configured IP address
	<sub mask> Configured subnet mask
	<gateway> Configured gateway address
	<pri DNS> Configured primary DNS address
	<sec DNS> Configured secondary DNS address
	<actual hostname> Assigned hostname
	<actual domain> Assigned domain
	<mac addr> Module MAC address.
Remarks	This query returns the configured Ethernet parameters. If the Ethernet interface is not configured then IP, subnet mask, gateway, primary DNS and secondary DNS parameters will be 0.0.0.0.
<hr/>	
OPST?	Operational Status Query
Input	OPST? [term]
Returned	<bit weighting> [term]
Format	nnn
Remarks	The integer returned represents the sum of the bit weighting of the operational status bits. Refer to section 6.2.5.2 for a list of operational status bits.
<hr/>	
OPSTE	Operational Status Enable Command
Input	OPSTE <bit weighting> [term]
Format	nnn
Remarks	Each bit has a bit weighting and represents the enable/disable mask of the corresponding operational status bit in the Operational Status Register. This determines which status bits can set the corresponding summary bit in the Status Byte Register. To enable a status bit, send the command OPSTE with the sum of the bit weighting for each desired bit. Refer to section 6.2.5.2 for a list of operational status bits.
<hr/>	
OPSTE?	Operational Status Enable Query
Input	OPSTE? [term]
Returned	<bit weighting> [term]
Format	nnn (Refer to section 6.2.5.2 for a list of operational status bits)

OPSTR? Operational Status Register Query

Input	OPSTR? [term]
Returned	<bit weighting> [term]
Format	nnn
Remarks	The integers returned represent the sum of the bit weighting of the operational status bits. These status bits are latched when the condition is detected. This register is cleared when it is read. Refer to section 6.2.5.2 for a list of operational status bits.

OUTMODE Output Mode Command

Input	OUTMODE <output>, <mode>, <input>, <powerup enable> [term]
Format	n,n,n,n
	<output> Specifies which output to configure: 1–4.
	<mode> Specifies the control mode. Valid entries: 0 = Off, 1 = Closed Loop PID, 2 = Zone, 3 = Open Loop, 4 = Monitor Out, 5 = Warmup Supply
	<input> Specifies which input to use for control: 0 = None, 1 = A, 2 = B, 3 = C, 4 = D (5 = Input D2, 6 = Input D3, 7 = Input D4, 8 = Input D5 for 3062 option)
	<powerup enable> Specifies whether the output remains on or shuts off after power cycle. Valid entries: 0 = powerup enable off, 1 = powerup enable on.
Example	OUTMODE 1,2,1,0[term] —Output 1 configured for Zone control mode, using Input A for the control input sensor, and will turn the output off when power is cycled.
Remarks	Modes 4 and 5 are only valid for Analog Outputs (3 and 4).

OUTMODE? Output Mode Query

Input	OUTMODE? <output> [term]
Format	n
	<output> Specifies which output to query: 1–4.
Returned	<mode>, <input>, <powerup enable> [term]
Format	n,n,n (refer to command for description)

PID Control Loop PID Values Command

Input	PID <output>, <P value>, <I value>, <D value> [term]
Format	n,+nnnnn,+nnnnn,+nnnn
	<output> Specifies which output's control loop to configure: 1 or 2.
	<P value> The value for output Proportional (gain): 0.1 to 1000.
	<I value> The value for output Integral (reset): 0.1 to 1000.
	<D value> The value for output Derivative (rate): 0 to 200.
Remarks	Control settings, (P, I, D, and Setpoint) are assigned to outputs, which results in the settings being applied to any loop formed by the output and its control input.
Example	PID 1,10,50,0[term] —Output 1 P is 10, I is 50, and D is 0%.

PID?	Control Loop PID Values Query
Input	PID? <output> [term]
Format	n
	<output> Specifies which output's control loop to query: 1 or 2.
Returned	<P value>,<I value>,<D value>[term]
Format	+nnnnn,+nnnnn,+nnnn (refer to command for description)
<hr/>	
RAMP	Control Setpoint Ramp Parameter Command
Input	RAMP <output>,<off/on>,<rate value> [term]
Format	n,n,nnnn
	<output> Specifies which output's control loop to configure: 1 or 2.
	<off/on> Specifies whether ramping is 0 = Off or 1 = On.
	<rate value> Specifies setpoint ramp rate in kelvin per minute from 0.1 to 100. The rate is always positive, but will respond to ramps up or down. A rate of 0 is interpreted as infinite, and will therefore respond as if setpoint ramping were off.
Example	RAMP 1,1,10.5[term] —when Output 1 setpoint is changed, ramp the current setpoint to the target setpoint at 10.5 K/minute.
Remarks	Control loop settings are assigned to outputs, which results in the settings being applied to the control loop formed by the output and its control input.
<hr/>	
RAMP?	Control Setpoint Ramp Parameter Query
Input	RAMP? <output> [term]
Format	n
	<output> Specifies which output's control loop to query: 1 or 2.
Returned	<off/on>,<rate value>[term]
Format	n,nnnn (refer to command for description)
<hr/>	
RAMPST?	Control Setpoint Ramp Status Query
Input	RAMPST? <output> [term]
Format	n
	<output> Specifies which output's control loop to query: 1 or 2.
Returned	<ramp status>[term]
Format	n
	<ramp status> 0 = Not ramping, 1 = Setpoint is ramping.
<hr/>	
RANGE	Heater Range Command
Input	RANGE <output>,<range> [term]
Format	n,n
	<output> Specifies which output to configure: 1–4.
	<range> For outputs 1 and 2: 0 = Off, 1 = Low, 2 = Medium, 3 = High For outputs 3 and 4: 0 = Off, 1 = On
Remarks	The range setting has no effect if an output is in the Off mode, and does not apply to an output in Monitor Out mode. An output in Monitor Out mode is always on.
<hr/>	
RANGE?	Heater Range Query
Input	RANGE? <output> [term]
Format	n
	<output> Specifies which output to query: 1–4.
Returned	<range>[term]
Format	n (refer to command for description)

RDGST?	Input Reading Status Query																		
Input	RDGST? <input> [term]																		
Format	a <input> Specifies which input to query: A–D (D1–D5 for 3062 option). <status bit weighting>[term]																		
Returned	nnn																		
Format																			
Remarks	The integer returned represents the sum of the bit weighting of the input status flag bits. A “000” response indicates a valid reading is present..																		
	<table> <thead> <tr> <th>Bit</th> <th>Bit Weighting</th> <th>Status Indicator</th> </tr> </thead> <tbody> <tr> <td>0</td> <td>1</td> <td>invalid reading</td> </tr> <tr> <td>4</td> <td>16</td> <td>temp underrange</td> </tr> <tr> <td>5</td> <td>32</td> <td>temp overrange</td> </tr> <tr> <td>6</td> <td>64</td> <td>sensor units zero</td> </tr> <tr> <td>7</td> <td>128</td> <td>sensor units overrange</td> </tr> </tbody> </table>	Bit	Bit Weighting	Status Indicator	0	1	invalid reading	4	16	temp underrange	5	32	temp overrange	6	64	sensor units zero	7	128	sensor units overrange
Bit	Bit Weighting	Status Indicator																	
0	1	invalid reading																	
4	16	temp underrange																	
5	32	temp overrange																	
6	64	sensor units zero																	
7	128	sensor units overrange																	

RELAY	Relay Control Parameter Command
Input	RELAY <relay number>,<mode>,<input alarm>,<alarm type> [term]
Format	n,n,a,n <relay number> Specifies which relay to configure: 1 or 2. <mode> Specifies relay mode. 0 = Off, 1 = On, 2 = Alarms. <input alarm> Specifies which input alarm activates the relay when the relay is in alarm mode: A - D (D1–D5 for 3062 option). <alarm type> Specifies the input alarm type that activates the relay when the relay is in alarm mode. 0 = Low alarm, 1 = High Alarm, 2 = Both Alarms.
Example	RELAY 1,2,B,0[term] –relay 1 activates when Input B low alarm activates.

RELAY?	Relay Control Parameter Query
Input	RELAY? <relay number> [term]
Format	n <relay number> Specifies which relay to query: 1 or 2.
Returned	<mode>,<input alarm>,<alarm type>[term]
Format	n,a,n (refer to command for description)

RELAYST?	Relay Status Query
Input	RELAYST? <relay number> [term]
Format	n <relay number> Specifies which relay to query: 1 or 2.
Returned	<status>[term]
Format	n 0 = Off, 1 = On.

SCAL Generate SoftCal Curve Command

Input	SCAL <std>, <dest>, <SN>, <T1 value>, <U1 value>, <T2 value>, <U2 value>, <T3 value>, <U3 value> [term]
Format	n,nn,S[10],+nnnnnn,±nnnnnn,+nnnnnn,±nnnnnn,+nnnnnn,±nnnnnn <std> Specifies the standard curve from which to generate a SoftCal™ curve. Valid entries: 1, 6, 7. <dest> Specifies the user curve to store the SoftCal™ curve. Valid entries: 21–59. <SN> Specifies the curve serial number. Limited to 10 characters. <T1 value> Specifies first temperature point in kelvin. <U1 value> Specifies first sensor units point. <T2 value> Specifies second temperature point in kelvin. <U2 value> Specifies second sensor units point. <T3 value> Specifies third temperature point in kelvin. <U3 value> Specifies third sensor units point.
Remarks	Generates a SoftCal™ curve. Refer to Paragraph 5.3.
Example	SCAL 1,21,1234567890,4.2,1.6260,77.32,1.0205,300.0,0.5189[term]—generates a three-point SoftCal™ curve from standard curve 1 and saves it in user curve 21.

SETP Control Setpoint Command

Input	SETP <output>, <value> [term]
Format	n,±nnnnnn <output> Specifies which output's control loop to configure: 1–4. <value> The value for the setpoint (in the preferred units of the control loop sensor).
Example	SETP 1,122.5[term] —Output 1 setpoint is now 122.5 (based on its units).
Remarks	For outputs 3 and 4, setpoint is only valid in Warmup mode. Control settings, that is, P, I, D, and Setpoint, are assigned to outputs, which results in the settings being applied to the control loop formed by the output and its control input.

SETP? Control Setpoint Query

Input	SETP? <output> [term]
Format	n <output> Specifies which output to query: 1–4.
Returned	<value>[term]
Format	±nnnnnn (refer to command for description)

SRDG? Sensor Units Input Reading Query

Input	SRDG? <input> [term]
Format	a <input> Specifies input to query: A-D (D1–D5 for 3062 option)
Returned	<temp value> Or if all inputs are queried: <A value>, <B value>, <C value>, <D value>
Format	+nnnnnn[term] Or if all inputs are queried: +nnnnn,+nnnnn,+nnnnn,+nnnnn[term]
Remarks	Returns the sensor inputs reading for a single input or all inputs. <input> specifies which input(s) to query. 0 = all inputs. Also see the RDGST? command.

TEMP?	Thermocouple Junction Temperature Query
Input	TEMP? [term]
Returned	<junction temperature>[term]
Format	+nnnnn
Remarks	Temperature is in kelvin. This query returns the temperature of the ceramic thermocouple block used in the room temperature compensation calculation
<hr/>	
TLIMIT	Temperature Limit Command
Input	TLIMIT <input>, <limit> [term]
Format	a,+nnnn <input> Specifies which input to configure: A–D (D1–D5 for 3062 option). <limit> The temperature limit in kelvin for which to shut down all control outputs when exceeded. A temperature limit of zero turns the temperature limit feature off for the given sensor input.
Example	TLIMIT B,450[term] —if the temperature of the sensor on Input B exceeds 450 K, all control outputs will be turned off.
Remarks	A temperature limit setting of 0 K turns the temperature limit feature off.
<hr/>	
TLIMIT?	Temperature Limit Query
Input	TLIMIT? <input> [term]
Format	a <input> Specifies which input to query: A–D (D1–D5 for 3062 option). <limit>[term]
Returned	<limit>[term]
Format	+nnnn (refer to command for description)
<hr/>	
TUNEST?	Control Tuning Status Query
Input	TUNEST? [term]
Returned	<tuning status>,<output>,<error status>,<stage status>[term]
Format	n,n,n,nn <tuning status> 0 = no active tuning, 1 = active tuning. <output> Heater output of the control loop being tuned (if tuning): 1 = output 1, 2 = output 2 <error status> 0 = no tuning error, 1 = tuning error <stage status> Specifies the current stage in the Autotune process. If tuning error occurred, stage status represents stage that failed.
Remarks	If initial conditions are not met when starting the autotune procedure, causing the autotuning process to never actually begin, then the error status will be set to 1 and the stage status will be stage 00.

WARMUP Warmup Supply Parameter Command

Input	WARMUP <output>, <control>, <percentage> [term]
Format	n,n,+nnn.nn <output> Specifies which unpowered analog output to configure: 3 or 4 <control> Specifies the type of control used: 0 = Auto Off, 1 = Continuous <percentage> Specifies the percentage of full scale (10 V) Monitor Out voltage to apply to turn on the external power supply.
Example	WARMUP 3,1,50[term] —Output 3 will use the Continuous control mode, with a 5 V (50%) output voltage for activating the external power supply.
Remarks	The Output Mode parameter and the Control Input parameter must be configured using the OUTMODE command.

WARMUP? Warmup Supply Parameter Query

Input	WARMUP? <output> [term]
Format	n,+nnn.nn <output> Specifies which unpowered analog output to query: 3 or 4.
Returned	<control>,<percentage>[term]
Format	n,+nnn (refer to command for description)

WEBLOG Website Login Parameters

Input	WEBLOG <username>, <password> [term]
Format	s[15],s[15] <username> 15 character string representing the website username. <password> 15 character string representing the website password.
Example	WEBLOG “user”, “pass” —sets the username to user and the password to pass.
Remarks	Strings can be sent with or without quotation marks, but to send a string that contains spaces, commas, or semi-colons quotation marks must be used to differentiate the actual parameter separator.

WEBLOG? Website Login Parameter Query

Input	WEBLOG? [term]
Returned	<username>,<password>[term]
Format	s[15],s[15] (refer to command for description)
Remarks	Note that all strings returned by the Model 336 will be padded with spaces to maintain a constant number of characters.

ZONE Control Loop Zone Table Parameter Command

Input	ZONE <output>, <zone>, <upper bound>, <P value>, <I value>, <D value>, <mout value>, <range>, <input>, <rate> [term]
Format	n,nn,+nnnnn,+nnnnn,+nnnnn,+nnnnn,+nnnnn,n,n,+nnnn [term] <output> Specifies which heater output to configure: 1 or 2. <zone> Specifies which zone in the table to configure. Valid entries are: 1–10. <upper bound> Specifies the upper Setpoint boundary of this zone in kelvin. <P value> Specifies the P for this zone: 0.1 to 1000. <I value> Specifies the I for this zone: 0.1 to 1000. <D value> Specifies the D for this zone: 0 to 200%. <mout value> Specifies the manual output for this zone: 0 to 100%. <range> Specifies the heater range for this zone. Valid entries: 0 = Off, 1 = Low, 2 = Med, 3 = High. <input> Specifies the sensor input to use for this zone. 0 = Default (Use previously assigned sensor), 1 = Input A, 2 = Input B, 3 = Input C, 4 = Input D (5 = Input D2, 6 = Input D3, 7 = Input D4, 8 = Input D5 for 3062 option) <rate> Specifies the ramp rate for this zone: 0.1–100 K/min.
Remarks	Configures the output zone parameters. Refer to Paragraph 2.9.
Example	ZONE 1,1,25.0,10,20,0,0,2,2,10 [term]—Output 1 zone 1 is valid to 25.0 K with P = 10, I = 20, D = 0, a heater range of medium, sensor input B, and a ramp rate of 10 K/min.

ZONE? Output Zone Table Parameter Query

Input	ZONE? <output>, <zone> [term]
Format	n,nn <output> Specifies which heater output to query: 1 or 2. <zone> Specifies which zone in the table to query. Valid entries: 1–10.
Returned	< upper boundary>,<P value>,<I value>,<D value>,<mout value>,<range>,<input>,<rate>[term]
Format	+nnnnn,+nnnnn,+nnnnn,+nnnn,+nnnnn,n,n,+nnnn (refer to command for description)

Chapter 7: Options and Accessories

7.1 General

This chapter provides information on the models, options, and accessories available for the Model 336 temperature controller.

7.2 Models

The list of Model 336 model numbers is provided as follows:

Model	Description of Models
336	Standard temperature controller. 4 diode/RTD inputs and 4 control outputs

TABLE 7-1 Model description

Power configurations—the instrument is configured at the factory for customer-selected power as follows:

1	100 V-US (NEMA 5-15)
2	120 V-US (NEMA 5-15)
3	220 V-EU (CEE 7/7)
4	240 V-EU (CEE 7/7)
5	240 V-UK (BS 1363)
6	240 V-Swiss (SEV 1011)
7	220 V-China (GB 1002)

TABLE 7-2 Power configurations

7.3 Options

The list of Model 336 options is provided as follows:

Model	Description of Options
3060	Dual Thermocouple Input Option Card. Adds 2 thermocouple inputs to the Model 336.
3061	Capacitance Input Option Card. Adds one capacitive sensor input to the Model 336.
3062	Diode/RTD Expansion Input Option Card. Adds 4 scanner diode/RTD inputs to the Model 336.

TABLE 7-3 Model description

7.4 Accessories

Accessories are devices that perform a secondary duty as an aid or refinement to the primary unit. Refer to the Lake Shore Temperature Measurement and Control Catalog for details. A list of accessories available for the Model 336 is as follows:

Model	Description of Accessories
106-009*†	Heater Output Connector. Dual banana jack for heater output.
G-106-233*†	Sensor Input Mating Connector. 6-pin DIN plug for diode/resistor input; 4 included
G-106-755*†	Terminal Block Mating Connector. 10-pin terminal block for relays and Outputs 3 and 4.
115-006*†	Detachable 120 VAC Line Cord.
MAN-336*†	Model 336 Temperature Controller User's Manual.
112-177	Sensor/Heater Cable Assembly—10 Feet. Cable assembly for 2 diode/resistor sensors and 1 heater output. Approximately 3 m (10 ft) long. Requires 2 to use 4 sensors and 2 heaters. Refer to FIGURE 7-1.
112-178	Sensor/Heater Cable Assembly —20 Feet. Cable assembly for 2 diode/resistor sensors and 1 heater output. Approximately 6 m (20 ft) long. Requires 2 to use 4 sensors and 2 heaters. Refer to FIGURE 7-1.
112-180	Sensor/Heater Cable Assembly —33 Feet. Cable assembly for 2 diode/resistor sensors and 1 heater output. Approximately 10 m (33 ft) long. Requires 2 to use 4 sensors and 2 heaters. Refer to FIGURE 7-1.
6201†	IEEE-488 Cable. 1 m (3 ft) long IEEE-488 computer interface cable.
CAL-336-CERT†	Instrument recalibration with certificate.

TABLE 7-4 Accessories

Model	Description of Accessories
CAL-336-DATA†	Instrument recalibration with certificate and data.
ES-2-20	Stycast® Epoxy 2850-FT, Catalyst 9 (20 packets, 2 g each). Stycast® is a common, highly versatile, nonconductive epoxy resin system for cryogenic use. The primary use for Stycast® is for vacuum feedthroughs or permanent thermal anchors. Stycast® is an alternative to Apiezon® N Grease when permanent sensor mountings are desired.
ID-10-XX	Indium Solder Disks (Quantity 10). Indium is a semi-precious non-ferrous metal, softer than lead, and extremely malleable and ductile. It stays soft and workable down to cryogenic temperatures. Indium can be used to create solder "bumps" for microelectronic chip attachments and also as gaskets for pressure and vacuum sealing purposes. ID-10-31 Indium Disks are 7.92 mm diameter × 0.13 mm (0.312 in diameter × 0.005 in) ID-10-56 Indium Disks are 14.27 mm diameter × 0.127 mm (0.562 diameter × 0.005 in)
IF-5	Indium Foil Sheets (Quantity 5). When used as a washer between DT-470-CU silicon diode or other temperature sensors and refrigerator cold stages, indium foil increases the thermal contact area and prevents the sensor from detaching due to vibration. It also may be used as a sealing gasket for covers, flanges, and windows in cryogenic applications. Each sheet is 0.13 mm × 50.8 mm × 50.8 mm (0.005 in × 2 in × 2 in).
GAH-25	Apiezon® H Grease, 25 g Tube. It is designed for general purposes where operating temperatures necessitate the use of a relatively high melting point grease. Melting point is 523 K (250 °C). Can be removed using Xylene with an isopropyl alcohol rinse.
GAN-25	Apiezon® N Grease, 25 g Tube. General purpose grease well-suited for cryogenic use because of its low viscosity. It is often used as a means of thermally anchoring cryogenic sensors as well as lubricating joints and o-rings. Contains high molecular weight polymeric hydrocarbon additive that gives it a tenacious, rubbery consistency allowing the grease to form a cushion between mating surfaces. Melting point is 316 K (43 °C). Can be removed using Xylene with an isopropyl alcohol rinse.
HTR-25	25 Ω Cartridge Heater. The heater features precision-wound nickel-chromium resistance wire, magnesium oxide insulation, 2 solid pins, non-magnetic package, and has UL and CSA component recognition. The heater is 25 Ω, 6.35 mm (0.25 in) diameter by 25.4 mm (1 in) long. The 25 Ω rating is in dead air. With proper heat sinking, the cartridge heater can handle many times this dead air power rating.
HTR-50	50 Ω Cartridge Heater. The heater features precision-wound nickel-chromium resistance wire, magnesium oxide insulation, 2 solid pins, non-magnetic package, and has UL and CSA component recognition. The heater is 50 Ω, 6.35 mm (0.25 in) diameter by 25.4 mm (1 in) long. The 50 Ω rating is in dead air. With proper heat sinking, the cartridge heater can handle many times this dead air power rating.
RM-1	Rack Mounting Kit. Mounting brackets, ears, and handles to attach 1 Model 336 to a 482.6 mm (19 in) rack mount cabinet. See FIGURE 7-2.
VGE-7031	IMI-7031 Varnish (formerly GE 7031 Varnish) (1 pint can). IMI-7031 Insulating Varnish and Adhesive possesses electrical and bonding properties which, when combined with its chemical resistance and good saturating properties, make it an excellent material for cryogenic temperatures. As an adhesive, IMI-7031 bonds a variety of materials, has fast tack time, and may be air dried or baked. It is also an electrically insulating adhesive at cryogenic temperatures and is often used as a calorimeter cement. When soaked into cigarette paper, it makes a good, high thermal conductivity, low electrical conductivity heat sinking layer. Maximum operating temperature: 423 K (150 °C).
Wire	Lake Shore Cryogenic Wire. Lake Shore sells the following types of cryogenic wire: DT = Duo-Twist, MN = Single Strand, MW = Manganin, NC = Nichrome Heater, ND = Heavy Duty, QL = Quad-Lead, and QT = Quad-Twist. Lake Shore Coaxial Cable. Lake Shore sells the following types of coaxial cable: CC = Ultra Miniature Coaxial Cable, SR = Semi-Rigid Coaxial Cable, CRYC = CryoCable.

*Accessories included with a new Model 336

†RoHS compliant

TABLE 7-4 Accessories

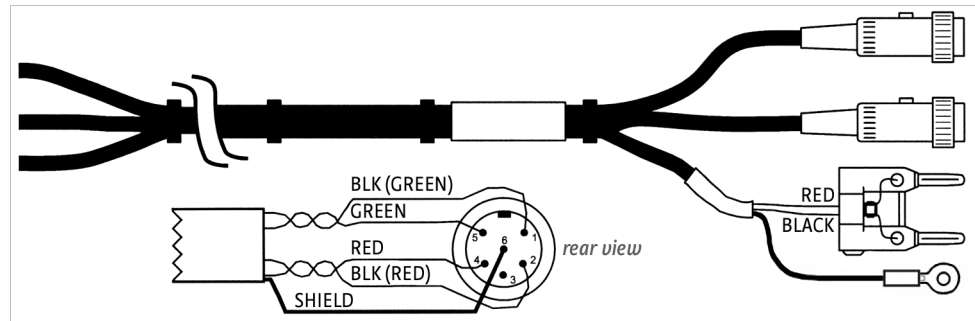

FIGURE 7-1 Model 336 sensor and heater cable assembly
10 ft: P/N 112-177, 20 ft: P/N 112-178, 33 ft: P/N 112-180

7.5 Rack Mounting

The Model 336 can be installed into a 482.6 mm (19 in) rack mount cabinet using the optional Lake Shore Model RM-1 Rack Mount Kit. The kit contains mounting ears, handles and screws that adapt the front of the instrument to fit into a 88.9 mm (3.5 in) tall, full rack space. Additional support may be required in the rear of the instrument and to relieve strain on heavy cables. The mounting ears are painted and do not guarantee good electrical contact between the instrument and cabinet. They should not be used for ground strapping unless paint is removed from under all screws.



Ensure that there is a 25 mm (1 in) clearance on both sides of the instrument after rack mounting.

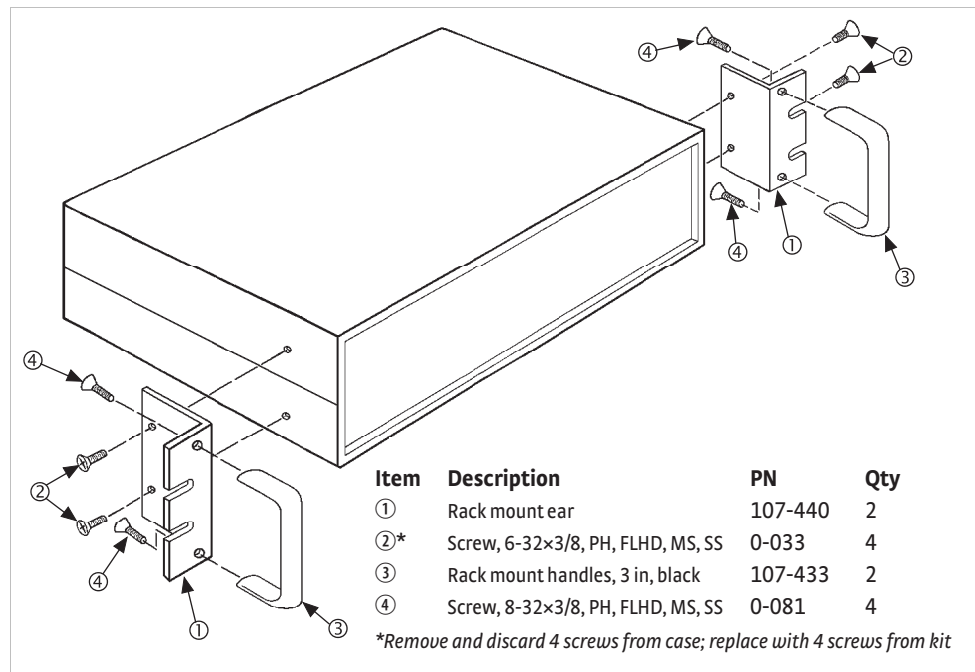

FIGURE 7-2 Model RM-1 rack mount kit

7.6 Input Option Card Installation

The field installable Model 3060 adds thermocouple functionality to inputs C and D, the Model 3061 adds capacitance functionality to input D, and the Model 3062 adds 4 scanners to input D. While the options can be easily removed, this is not necessary as the standard inputs remain fully functional when they are not being used to measure thermocouple or capacitance temperature sensors. Calibration for the options are stored on the card so you can install it in the field and use it with multiple Model 336 temperature controllers without recalibration.

7.6.1 Input Option Card Installation

The Model 336 input option cards are field-installable. You will need a small Phillips-head screwdriver and the 5/64-in hex driver. Follow this procedure to install an input option card.



To avoid potentially lethal shocks, turn off controller and disconnect it from AC power before performing these procedures.



The components on this board are electrostatic discharge sensitive (ESDS) devices. Follow ESD procedures in section 8.11 to avoid inducing an electrostatic discharge (ESD) into the device.



If you are installing the Model 3061, use the instructions for the full rack only. The Model 3060 can be installed in either a full or half rack.

1. Turn the Model 336 power switch Off. Unplug the power cord from the wall outlet, then from the instrument.
2. *Half rack only:* Remove the two screws used to attach the ceramic block to the full-rack adapter plate; set aside the screws, and discard the full-rack adapter plate.
3. Stand the unit on its face. Use the hex driver to remove the 4 screws on both sides of the top cover. Loosen the 2 rear bottom screws (FIGURE 7-3).

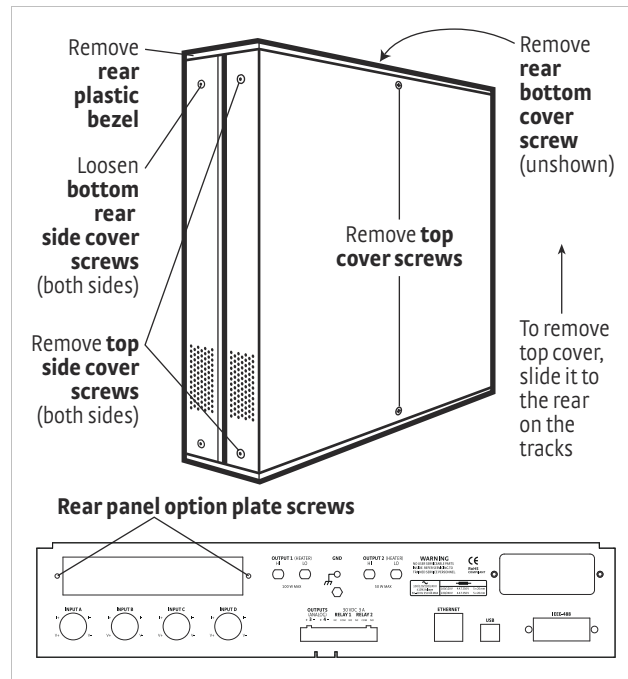

FIGURE 7-3 Cover and option plate screws (full rack)

4. *Full rack only:* use a small Phillips screwdriver to remove the 2 top cover screws and 1 rear bottom screw (FIGURE 7-3).
5. Remove the rear plastic bezel. The cover is tracked. Slide the top cover to the rear on the track to remove it.
6. Remove the rear panel option plate screws and set aside. Remove the rear panel option plate.
7. With the instrument still standing on its face, turn it to view the inside circuit board.
8. Place the option card into its position in the rear panel from inside the instrument. Orient the card so that the 14-pin ribbon cable connector is toward the bottom of the instrument, closest to the main circuit board (FIGURE 7-4).
9. *Half rack only:* use the screws removed in step 1 to attach the card by starting both screws in a few threads before tightening either.

10. *Full rack only:* use the screws removed in step 6 to attach the card by starting both screws in a few threads before tightening either.
11. Fully tighten both screws
12. *This step is not applicable to the 3062 option card.* Insert the 14-pin ribbon cable connector plug into the socket on the option board. Orient the ribbon cable connector plug so that the arrow nub slides into the plug slot, and the ribbon cable exits downward (FIGURE 7-4).

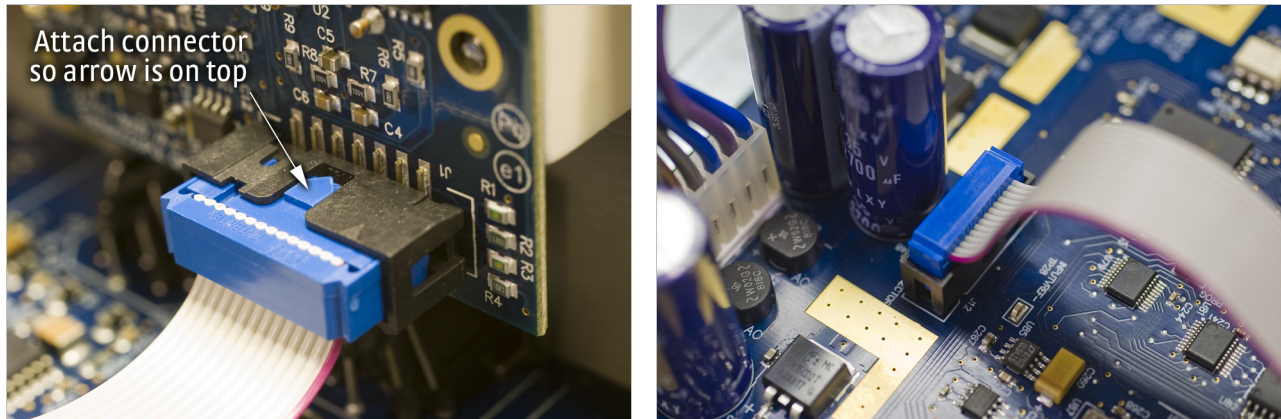

FIGURE 7-4 *Proper orientation of the ribbon cable connector plug*

13. Plug the other end of the cable into the main board, option connector J12 (FIGURE 8-11).
14. Slide the top panel forward in the track provided on each side of the unit.
15. Replace the rear plastic bezel by sliding it straight into the unit.
16. *Full rack only:* use a small Phillips head screwdriver to replace the 2 top cover screws and the 1 bottom cover screw.
17. Use the hex key to replace the 4 screws on the sides of the top covers. Tighten the two rear bottom screws.
18. Replace the power cord in the rear of the unit and set the power switch to On.
19. To verify option card installation, check the instrument information by pressing and holding the **Escape** key. Refer to section 8.7 for more information on instrument information.

Chapter 8: Service

8.1 General

This chapter provides basic service information for the Model 336 temperature controller. Customer service of the product is limited to the information presented in this chapter. Factory trained service personnel should be consulted if the instrument requires repair.

8.2 USB Troubleshooting

This section provides USB interface troubleshooting for issues that arise with new installations, existing installations, and intermittent lockups.

8.2.1 New Installation

1. Check that the instruments interface is set to USB.
2. Check that the USB driver is installed properly and that the device is functioning. In Microsoft Windows®, the device status can be checked using Device Manager by right-clicking **Lake Shore Model 336 Temperature Controller** under **Ports (COM & LPT)** or **Other Devices** and then clicking **Properties**. Refer to section 6.3.3 for details on installing the USB driver.
3. Check that the correct com port is being used. In Microsoft Windows®, the com port number can be checked using Device Manager under **Ports (COM & LPT)**.
4. Check that the correct settings are being used for communication. Refer to section 6.3.3 for details on installing the USB driver.
5. Check cable connections and length.
6. Send the message terminator.
7. Send the entire message string at one time including the terminator. (Many terminal emulation programs do not.)
8. Send only one simple command at a time until communication is established.
9. Be sure to spell commands correctly and use proper syntax.

8.2.2 Existing Installation No Longer Working

1. Power the instrument off, then on again to see if it is a soft failure.
2. Power the computer off, then on again to see if communication port is locked up.
3. Check all cable connections.
4. Check that the com port assignment has not been changed. In Microsoft Windows®, the com port number can be checked using Device Manager under **Ports (COM & LPT)**.
5. Check that the USB driver is installed properly and that the device is functioning. In Microsoft Windows®, the device status can be checked using Device Manager by right-clicking **Lake Shore Model 336 Temperature Controller** under **Ports (COM & LPT)** or **Other Devices** and then clicking **Properties**.

8.2.3 Intermittent Lockups

1. Check cable connections and length.
2. Increase the delay between all commands to 100 ms to make sure the instrument is not being overloaded.
3. Ensure that the USB cable is not unplugged and that the Model 336 is not powered down while the com port is open. The USB driver creates a com port when the USB connection is detected, and removes the com port when the USB connection is no longer detected. Removing the com port while in use by software can cause the software to lock up or crash.

8.3 IEEE Interface Troubleshooting

8.3.1 New Installation

This section provides IEEE interface troubleshooting for issues that arise with new installations, old installations, and intermittent lockups.

1. Check the instrument address.
2. Always send a message terminator.
3. Send the entire message string at one time including the terminator.
4. Send only one simple command at a time until communication is established.
5. Be sure to spell commands correctly and use proper syntax.
6. Attempt both Talk and Listen functions. If one works but not the other, the hardware connection is working, so look at syntax, terminator, and command format.

8.3.2 Existing Installation No Longer Working

1. Power the instrument off, then on again to see if it is a soft failure.
2. Power the computer off then on again to see if the IEEE card is locked up.
3. Verify that the address has not been changed on the instrument during a memory reset.
4. Check all cable connections.

8.3.3 Intermittent Lockups

1. Check cable connections and length.
2. Increase the delay between all commands to 50 ms to make sure the instrument is not being overloaded.

8.4 Fuse Drawer

The fuse drawer supplied with the Model 336 holds the instrument line fuses and line voltage selection module. The drawer holds two 5 mm × 20 mm (0.2 in × .79 in) time delay fuses. It requires two good fuses of the same rating to operate safely. Refer to Section 8.5 for details.

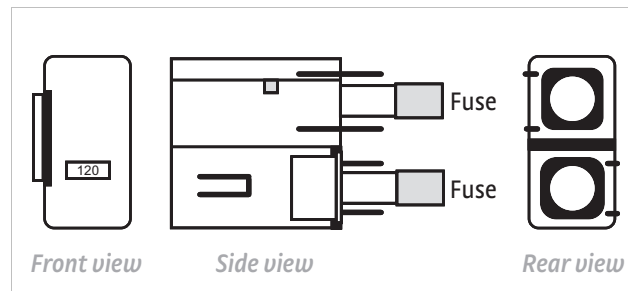

FIGURE 8-1 Fuse drawer

8.5 Line Voltage Selection

Use the following procedure to change the instrument line voltage selector.



To avoid potentially lethal shocks, turn off the controller and disconnect it from AC power before performing these procedures.

1. Identify the line input assembly on the instrument rear panel. See FIGURE 8-2.
2. Turn the line power switch OFF (O).
3. Remove the instrument power cord.
4. With a small screwdriver, release the drawer holding the line voltage selector and fuse.
5. Slide out the removable plastic fuse holder from the drawer.
6. Rotate the fuse holder until the proper voltage indicator shows through the window.
7. Re-assemble the line input assembly in the reverse order.
8. Verify the voltage indicator in the window of the line input assembly.
9. Connect the instrument power cord.
10. Turn the line power switch On (I) Refer to FIGURE 8-2.

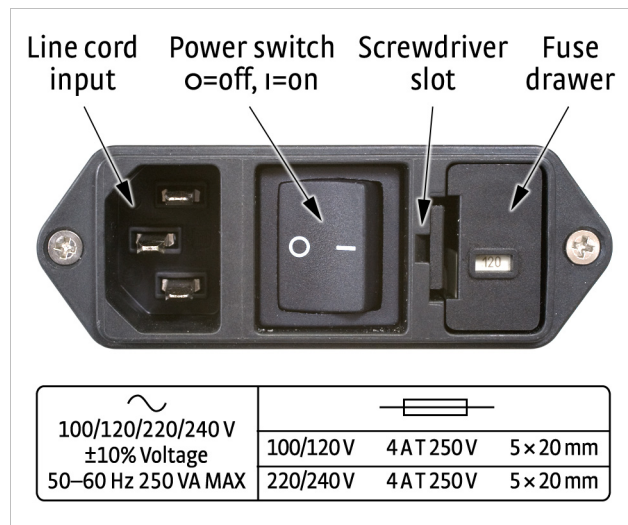

FIGURE 8-2 Power fuse access

8.6 Fuse Replacement

Use this procedure to remove and replace a line fuse.



WARNING

To avoid potentially lethal shocks, turn off controller and disconnect it from AC power before performing these procedures.



CAUTION

For continued protection against fire hazard, replace only with the same fuse type and rating specified for the line voltage selected.



NOTE

Test fuse with an ohmmeter. Do not rely on visual inspection of fuse.

1. Locate the line input assembly on the instrument rear panel. See Figure 8-2.
2. Turn the power switch Off (O).
3. Remove the instrument power cord.
4. With a small screwdriver, release the drawer holding the line voltage selector and fuse.
5. Remove existing fuse(s). Replace with proper Slow-Blow (time-delay) fuse ratings as follows:

100/120V	4 AT 250V	5 x 20 mm
220/240V	4 AT 250V	5 x 20 mm

6. Re-assemble the line input assembly in reverse order.
7. Verify voltage indicator in the line input assembly window.
8. Connect the instrument power cord.
9. Turn the power switch On (I).

8.7 Factory Reset Menu

It is sometimes necessary to reset instrument parameter values or clear the contents of curve memory. Both are stored in nonvolatile memory called NOVRAM, but they can be cleared individually. Instrument calibration is not affected except for Room Temperature Calibration, which should be recalibrated after parameters are set to default values or any time the thermocouple curve is changed.

8.7.1 Default Values

The factory defaults can be reset, and the user curves cleared, using the Factory Reset menu. To access the Factory Reset menu, press and hold the Escape key for 5 s. Once the menu appears, set either Reset to Defaults or Clear Curves, or both, to Yes, then highlight Execute and press Enter.

Input Setup – General	Default
Sensor type	Diode
Filter	Off
Input name	Input A (B, C, D)
Temperature limit	0 K (Off)
Input units	Kelvin
Curve	DT-670
Input Setup – Diode	Default
Range	2.5 V (Silicon)
Diode current	10 μ A
Input Setup – Platinum/NTC RTD	Default
Autorange	On
Current reversal	On
Input Setup – Thermocouple	Default
Room comp	On
Room cal	Cleared
Output Setup	Default
Output mode	Closed loop PID (off for Output 3 and 4)
Control input	Input A for Output 1; Input B for Output 2 none for output 3 and 4
Heater resistance	25 Ω
Power up enable	Off
Heater out display	Current
Setpoint ramping	Off
Display Setup	Default
Display mode	Custom
Number of locations	2 (large)
Location 1 source	Input A
Location 1 units	Kelvin
Location 2 source	Input B
Location 2 units	Kelvin
Location 3 source	Input C
Location 3 units	Kelvin
Location 4 source	Input D
Location 4 units	Kelvin
Location 5 source	Input A
Location 5 units	Sensor
Location 6 source	Input B
Location 6 units	Sensor
Location 7 source	Input C
Location 7 units	Sensor
Location 8 source	Input D
Location 8 units	Sensor
Contrast	28

Interface Setup – General	Default
Enabled	USB
Interface Setup – IEEE	Default
IEEE Address	12
Interface Setup – Ethernet	Default
DHCP	On
Auto-IP	Off
Static-IP	192.168.0.12
Static Subnet Mask	255.255.255.0
Static Gateway	192.168.0.1
Static Primary DNS	0.0.0.0
Static Secondary DNS	0.0.0.0
Preferred hostname	LSCI-336
Web username	user
Web password	
Alarm	Default
Alarm	Off
Relay	Default
Relay	Off
Keypad Locking	Default
Mode	Unlocked
Lock code	123
PID/Manual Heater Power (MHP) Output	Default
Proportional (P)	50.0
Integral (I)	20.0
Derivative (D)	0.0
Manual Output	0.000%
Heater	Default
Heater range	Off
Setpoint	Default
Setpoint value	0.000 K
Remote/Local	Default
Remote/Local	Local
Zone Settings – All Zones	Default
Upper boundary	0.000 K
Proportional (P)	50.0
Integral (I)	20.0
Derivative (D)	0.00
Manual output	0.000%
Range	Off
Ramp rate	0.100 K/min
Control input	Default

TABLE 8-1 Default values

8.7.2 Product Information

Product information for your instrument is also found in the Factory Reset menu. The following information is provided:

- Firmware version
- Firmware date
- Serial number
- Option card type
- Option card serial number
- Ethernet version

8.8 Error Messages

The following are error messages that may be displayed by the Model 336 during operation.

Message	Description
DISABL	Input is disabled. Refer to section 4.4.
NOCURV	Input has no curve, Refer to section 4.4.9.
S.OVER	Input is at or over full-scale sensor units.
S.UNDER	Input is at or under negative full-scale sensor units.
T.OVER	Input at or over the high end of the curve.
T.UNDER	Input at or under the low end of the curve.
Cannot Communicate with Input uP	The main microprocessor has lost communication with the sensor input microprocessor.
NOVRAM Corrupt	Invalid data or contents in NOVRAM—when this message appears, options are provided for resetting the instrument to default values, and for clearing all user curve locations (21– 59). To perform the reset, set the desired parameters to “Yes”, then choose the “Execute” option.
A temperature limit has been exceeded	The temperature reading on a sensor input has exceeded the Temperature Limit setting. A detailed message will follow, which includes a reference to which sensor input's temperature limit has been exceeded.
*** Keypad Locked ***	An attempt has been made to change a parameter while the keypad is locked. Refer to section 4.7.
*** Heater Short Circuit Detected ***	A short circuit condition has been observed on 1 of the heater outputs. A detailed message will follow, which includes a reference to which output caused the condition. The output will be turned off when this occurs.
*** Heater Open Circuit Detected ***	An open circuit condition has been observed on 1 of the heater outputs. A detailed message will follow, which includes a reference to which output caused the condition. The output will be turned off when this occurs.
*** Invalid Calibration ***	The calibration memory is either corrupt, or is at the default, uncalibrated state. This message appears when the Model 336 is first powered on. To clear the message, and continue with instrument start-up, press the Escape and Enter keys simultaneously.
*** Invalid Option Card Calibration ***	The installed option card calibration memory is either corrupt, or is at the default, uncalibrated state. This message appears when the Model 336 is first powered on. To clear the message, and continue with instrument start-up, press the Escape and Enter keys simultaneously.
*** Firmware Update in Progress ***	This indicates that the Model 336 is in firmware update mode.

TABLE 8-2 Error messages

8.9 Calibration Procedure

Instrument calibration can be obtained through Lake Shore Service. Refer to section 8.14 for technical inquiries and contact information.

8.10 Rear Panel Connector Definition

The sensor input, heater output, terminal block, USB, Ethernet, and IEEE-488 connectors are defined in FIGURE 8-3 through FIGURE 8-8. For thermocouple connector details refer to FIGURE 3-8.

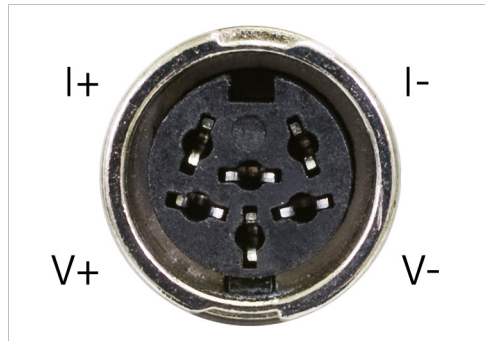

FIGURE 8-3 Sensor input A through D

Pin	Symbol	Description
1	I-	-Current
2	V-	-Voltage
3	None	Shield
4	V+	+Voltage
5	I+	+Current
6	None	Shield

TABLE 8-3 Sensor input A through D connector details

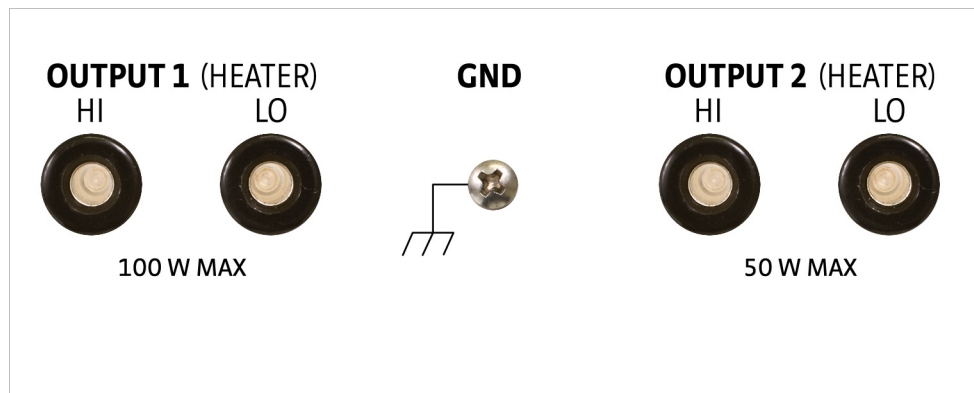

FIGURE 8-4 Heater output connectors

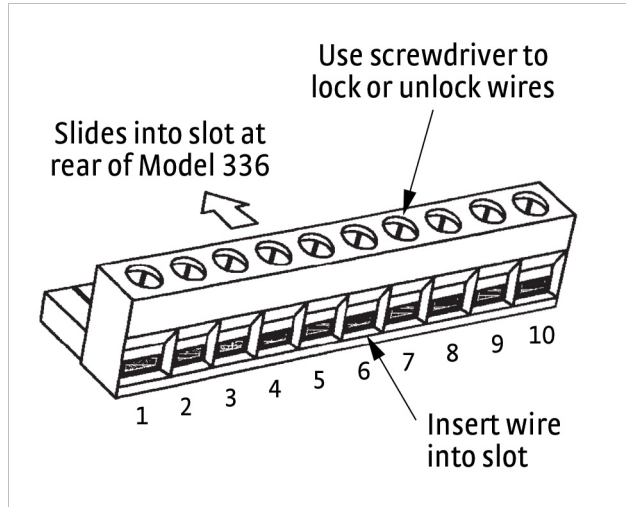

FIGURE 8-5 Terminal block for relays and Output 3 and 4

Pin	Description
1	Output 3+
2	Output 3-
3	Output 4+
4	Output 4-
5	Relay 1 normally closed
6	Relay 1 common
7	Relay 1 normally open
8	Relay 2 normally closed
9	Relay 2 common
10	Relay 2 normally open

TABLE 8-4 Terminal block pin and connector details

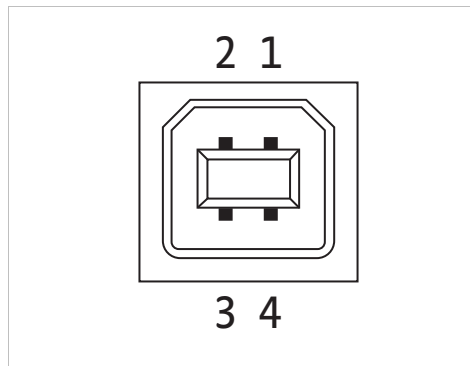

FIGURE 8-6 USB pin and connector details

Pin	Name	Description
1	VCC	+5 VDC
2	D-	Data -
3	D+	Data +
4	GND	Ground

TABLE 8-5 USB pin and connector details

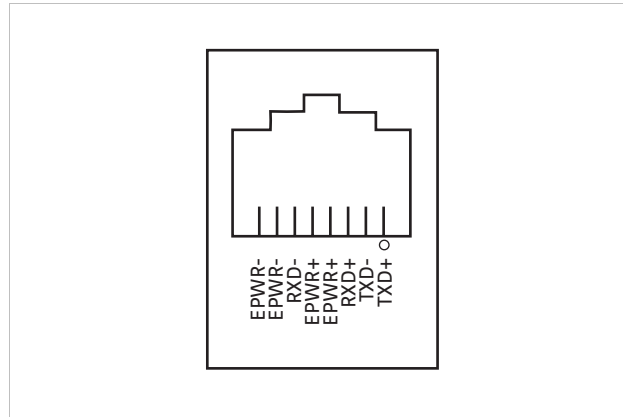

FIGURE 8-7 Ethernet pin and connector details

Pin	Symbol	Description
1	TXD+	Transmit data+
2	TXD-	Transmit data-
3	RXD+	Receive data+
4	EPWR+	Power from switch+ (not used)
5	EPWR+	Power from switch+ (not used)
6	RXD-	Receive data-
7	EPWR-	Power from switch- (not used)
8	EPWR-	Power from switch- (not used)

TABLE 8-6 Ethernet pin and connector details

8.10.1 IEEE-488 Interface Connector

Connect to the IEEE-488 Interface connector on the Model 336 rear with cables specified in the IEEE-488 standard. The cable has 24 conductors with an outer shield. The connectors are 24-way Amphenol 57 Series (or equivalent) with piggyback receptacles to allow daisy chaining in multiple device systems. The connectors are secured in the receptacles by 2 captive locking screws with metric threads.

The total length of cable allowed in a system is 2 m for each device on the bus, or 20 m maximum. The Model 336 can drive a bus of up to 10 devices. A connector extender is required to use the IEEE-488 interface and relay terminal block at the same time. FIGURE 8-8 shows the IEEE-488 interface connector pin location and signal names as viewed from the Model 336 rear panel.

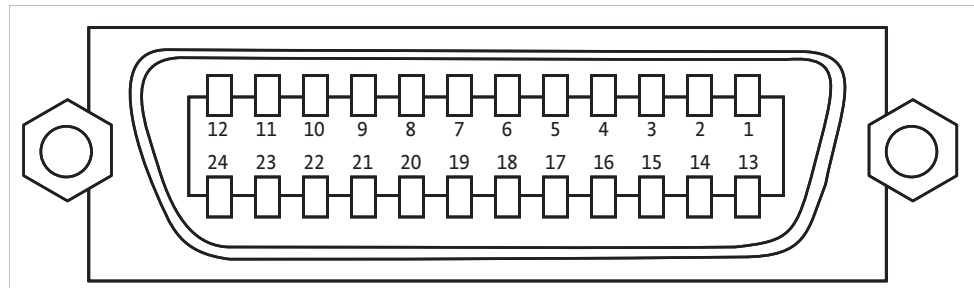

FIGURE 8-8 IEEE-488 interface

Pin	Symbol	Description
1	DIO 1	Data input/output line 1
2	DIO 2	Data input/output line 2
3	DIO 3	Data input/output line 3
4	DIO 4	Data input/output line 4
5	EOI	End or identify
6	DAV	Data valid
7	NRFD	Not ready for data
8	NDAC	No data accepted
9	IFC	Interface clear
10	SRQ	Service request
11	ATN	Attention
12	SHIELD	Cable shield
13	DIO 5	Data input/output line 5
14	DIO 6	Data input/output line 6
15	DIO 7	Data input/output line 7
16	DIO 8	Data input/output line 8
17	REN	Remote enable
18	GND 6	Ground wire—twisted pair with DAV
19	GND 7	Ground wire—twisted pair with NRFD
20	GND 8	Ground wire—twisted pair with NDAC
21	GND 9	Ground wire—twisted pair with IFC
22	GND 10	Ground wire—twisted pair with SRQ
23	GND 11	Ground wire—twisted pair with ATN
24	GND	Logic ground

TABLE 8-7 IEEE-488 rear panel connector details

8.11 Electrostatic Discharge

Electrostatic Discharge (ESD) may damage electronic parts, assemblies, and equipment. ESD is a transfer of electrostatic charge between bodies at different electrostatic potentials caused by direct contact or induced by an electrostatic field. The low-energy source that most commonly destroys Electrostatic Discharge sensitive devices is the human body, which generates and retains static electricity. Simply walking across a carpet in low humidity may generate up to 35,000 V of static electricity.

Current technology trends toward greater complexity, increased packaging density, and thinner dielectrics between active elements, which results in electronic devices with even more ESD sensitivity. Some electronic parts are more ESD sensitive than others. ESD levels of only a few hundred volts may damage electronic components such as semiconductors, thick and thin film resistors, and piezoelectric crystals during testing, handling, repair, or assembly. Discharge voltages below 4000 V cannot be seen, felt, or heard.

8.11.1 Identification of Electrostatic Discharge Sensitive Components

The following are various industry symbols used to label components as ESD sensitive.



FIGURE 8-9 Symbols indicating ESD sensitivity

8.11.2 Handling Electrostatic Discharge Sensitive Components

Observe all precautions necessary to prevent damage to ESDS components before attempting installation. Bring the device and everything that contacts it to ground potential by providing a conductive surface and discharge paths. As a minimum, observe these precautions:

- De-energize or disconnect all power and signal sources and loads used with unit.
- Place the unit on a grounded conductive work surface.
- The technician should be grounded through a conductive wrist strap (or other device) using 1 M series resistor to protect operator.
- Ground any tools, such as soldering equipment, that will contact the unit. Contact with the operator's hands provides a sufficient ground for tools that are otherwise electrically isolated.
- Place ESD sensitive devices and assemblies removed from a unit on a conductive work surface or in a conductive container. An operator inserting or removing a device or assembly from a container must maintain contact with a conductive portion of the container. Use only plastic bags approved for storage of ESD material.
- Do not handle ESD sensitive devices unnecessarily or remove them from the packages until they are actually used or tested.

8.12 Enclosure Top Remove and Replace Procedure

Follow this procedure to remove the top enclosure:



To avoid potentially lethal shocks, turn off the controller and disconnect it from AC power before performing these procedures.



The components on this board are electrostatic discharge sensitive (ESDS) devices. Follow ESD procedures in section 8.11 to avoid inducing an electrostatic discharge (ESD) into the device.

1. Turn the Model 336 power switch Off. Unplug the power cord from the wall outlet, then from the instrument.
2. Stand the unit on its face. Use a 5/64 in hex driver to remove the four screws on both sides of the top cover. Loosen the two rear bottom screws (FIGURE 8-10).

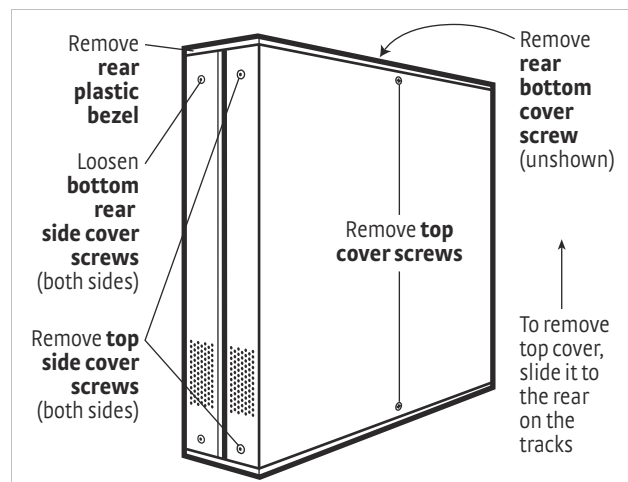

FIGURE 8-10 Cover removal

3. Use a small Phillips screwdriver to remove the two top cover screws and one rear bottom screw (FIGURE 8-10).
4. Remove the rear plastic bezel. The cover is tracked. Slide the top cover to the rear on the track to remove it.

Follow this procedure to install the top enclosure:

5. Slide the top panel forward in the track provided on each side of the unit.
6. Use a small Phillips screwdriver to replace the two top cover screws and 1 rear bottom screw.
7. Use the hex driver to replace the two screws on the side of the top covers.
8. Replace the rear plastic bezel by sliding it straight into the unit.
9. Tighten the two rear bottom screws.
10. Replace the power cord in the rear of the unit and set the power switch to On.

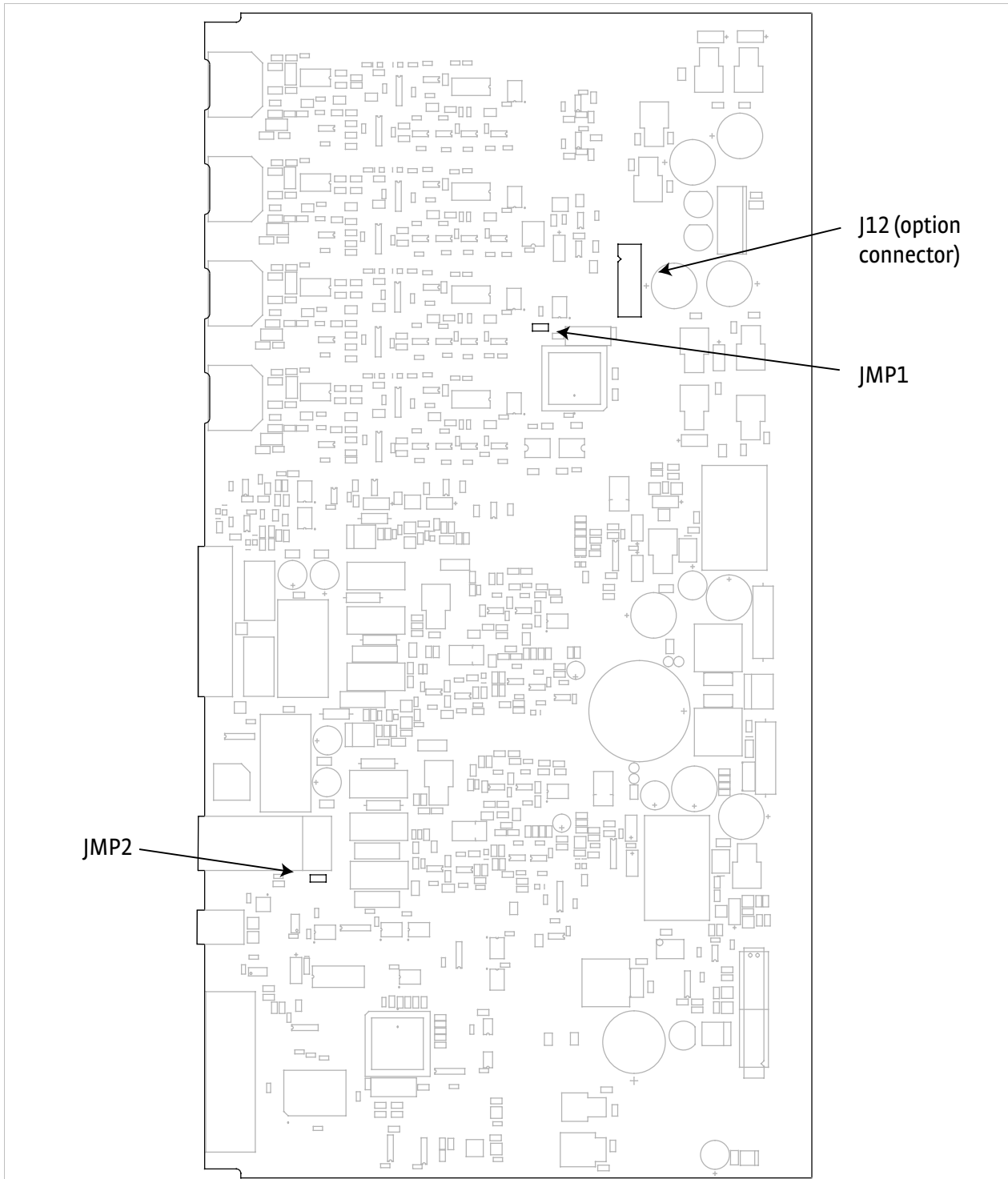

FIGURE 8-11 Location of internal components

8.13 Firmware Updates

This section provides instructions on updating your firmware. It also provides a table of the updates that have been made thus far.

8.13.1 Updating the Firmware

Periodically, Lake Shore provides updates to instrument firmware and Ethernet firmware. The files for these updates can be downloaded from our website. To access the firmware updates, follow this procedure.

1. Go to <http://www.lakeshore.com/products/cryogenic-temperature-controllers/model-336/Pages/Overview.aspx> to download the instrument and Ethernet firmware.
2. Enter your name and email address so that we can keep you updated on any new firmware for your instrument.
3. Click the “Go to the download” bar and follow the prompts that are provided on the screen for you.

8.13.2 Record of Updates Made to the Firmware

TABLE 8-8 and TABLE 8-9 describe the updates made to the temperature controller in each version.

Instrument firmware version	Features added
2.1	Closed loop PID and Zone modes available on Outputs 3 and 4 Setpoint “press-and-hold” loads current temperature to setpoint, bypassing ramping
2.2	Capacitance option card support added
2.3	Scanner option card support added
2.5	Added sensor name units for custom display mode

TABLE 8-8 Instrument firmware updates

Ethernet firmware version	Features added
1.1	Instrument configuration backup utility added
2.0	Chart recorder utility added Support for Model 350 added
2.1	Chart recorder and instrument configuration utilities updated to support Model 3062 scanner option card
2.2	Support for Model 224; increased TCP socket connections to 5; and added available TCP socket connections to Ethernet status page

TABLE 8-9 Ethernet firmware updates

8.14 Technical Inquiries

Refer to the following sections when contacting Lake Shore for application assistance or product service. Questions regarding product applications, price, availability and shipments should be directed to sales. Questions regarding instrument calibration or repair should be directed to instrument service. Do not return a product to Lake Shore without a Return Material Authorization (RMA) number (section 8.14.2).

8.14.1 Contacting Lake Shore

The Lake Shore Service Department is staffed Monday through Friday between the hours of 8:00 AM and 5:00 PM EST, excluding holidays and company shut down days.

Contact Lake Shore Service through any of the means listed below. However, the most direct and efficient means of contacting is to complete the online service request form at <http://www.lakeshore.com/sup/serf.html>. Provide a detailed description of the problem and the required contact information. You will receive a response within 24 hours or the next business day in the event of weekends or holidays.

If you wish to contact Service or Sales by mail or telephone, use the following:

Mailing address	Lake Shore Cryotronics Instrument Service Department 575 McCorkle Blvd. Westerville, Ohio USA 43082-8888	
E-mail address	sales@lakeshore.com service@lakeshore.com	Sales Instrument Service
Telephone	614-891-2244 614-891-2243 option 6	Sales Instrument Service
Fax	614-818-1600 614-818-1609	Sales Instrument Service
Web service request	http://www.lakeshore.com/sup/serf.html Instrument Service	

TABLE 8-10 Contact information

8.14.2 Return of Equipment

The temperature controller is packaged to protect it during shipment.



The user should retain any shipping carton(s) in which equipment is originally received, in the event that any equipment needs to be returned.

If the original packaging is not available, a minimum of 76.2 mm (3 in) of shock adsorbent packing material should be placed snugly on all sides of the instrument in a sturdy corrugated cardboard box. Please use reasonable care when removing the temperature controller from its protective packaging and inspect it carefully for damage. If it shows any sign of damage, please file a claim with the carrier immediately. Do not destroy the shipping container; it will be required by the carrier as evidence to support claims. Call Lake Shore for return and repair instructions.

All equipment returns must be approved by a member of the Lake Shore Service Department. The service engineer will use the information provided in the service request form and will issue an RMA. This number is necessary for all returned equipment. It must be clearly indicated on both the shipping carton(s) and any correspondence relating to the shipment. Once the RMA has been approved, you will receive appropriate documents and instructions for shipping the equipment to Lake Shore.

8.14.3 RMA Valid Period

RMAs are valid for 60 days from issuance; however, we suggest that equipment needing repair be shipped to Lake Shore within 30 days after the RMA has been issued. You will be contacted if we do not receive the equipment within 30 days after the RMA is issued. The RMA will be cancelled if we do not receive the equipment after 60 days.

8.14.4 Shipping Charges

All shipments to Lake Shore are to be made prepaid by the customer. Equipment serviced under warranty will be returned prepaid by Lake Shore. Equipment serviced out-of-warranty will be returned FOB Lake Shore.

8.14.5 Restocking Fee

Lake Shore reserves the right to charge a restocking fee for items returned for exchange or reimbursement.

Appendix A: Temperature Scales

A.1 Definition

Temperature is a fundamental unit of measurement that describes the kinetic and potential energies of the atoms and molecules of bodies. When the energies and velocities of the molecules in a body are increased, the temperature is increased whether the body is a solid, liquid, or gas. Thermometers are used to measure temperature. The temperature scale is based on the temperature at which ice, liquid water, and water vapor are all in equilibrium. This temperature is called the triple point of water and is assigned the value 0 °C, 32 °F, and 273.15 K. These 3 temperature scales are defined as follows:

- **Celsius**—abbreviation: °C. A temperature scale that registers the freezing point of water as 0 °C and the boiling point as 100 °C under normal atmospheric pressure. Formerly known as Centigrade. Originally devised by Anders Celsius (1701 - 1744), a Swedish astronomer.
- **Fahrenheit**—abbreviation: °F. A temperature scale that registers the freezing point of water as 32 °F and the boiling point as 212 °F under normal atmospheric pressure. Originally devised by Gabriel Fahrenheit (1686 - 1736), a German physicist residing in Holland; developed use of mercury in thermometry.
- **Kelvin**—abbreviation: K. An absolute scale of temperature, the zero point of which is approximately -273.15°C. Scale units are equal in magnitude to Celsius degrees. Originally devised by Lord Kelvin, William Thompson, (1824 - 1907), a British physicist, mathematician, and inventor.

A.2 Comparison

The 3 temperature scales are graphically compared in FIGURE A-1.

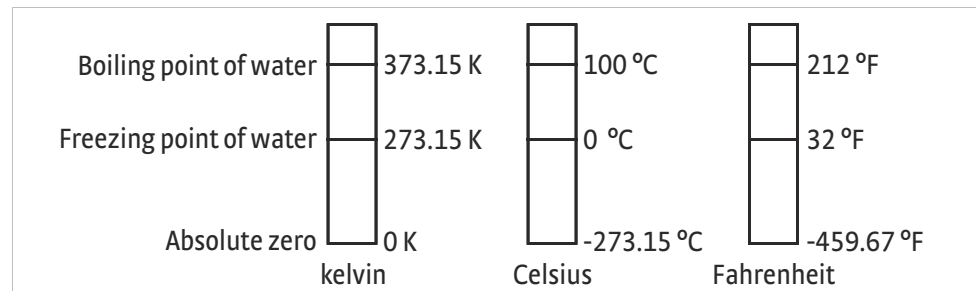

FIGURE A-1 Comparison of kelvin, Celsius and Fahrenheit temperature scales

A.3 Conversions

To convert Fahrenheit to Celsius: subtract 32 from °F then divide by 1.8, or:

$$^{\circ}\text{C} = (^{\circ}\text{F} - 32) \div 1.8$$

To convert Celsius to Fahrenheit: multiply °C by 1.8 then add 32, or:

$$^{\circ}\text{F} = (1.8 \times ^{\circ}\text{C}) + 32$$

To convert Fahrenheit to kelvin, first convert °F to °C, then add 273.15.

To convert Celsius to kelvin, add 273.15.

°F	°C	K	°F	°C	K	°F	°C	K
-459.67	-273.15	0	-292	-180	93.15	-129.67	-89.82	183.33
-454	-270	3.15	-290	-178.89	94.26	-120	-84.44	188.71
-450	-267.78	5.37	-289.67	-178.71	94.44	-119.67	-84.44	188.89
-449.67	-267.59	5.56	-280	-173.33	99.82	-117.67	-83.15	190
-441.67	-263.15	10	-279.67	-173.15	100	-112	-80	193.15
-440	-262.22	10.93	-274	-170	103.15	-110	-78.89	194.26
-439.67	-262.04	11.11	-270	-167.78	105.57	-109.67	-78.71	194.44
-436	-260	13.15	-269.67	-167.59	105.56	-100	-73.33	199.82
-430	-256.67	16.48	-261.67	-163.15	110	-99.67	-73.15	200
-429.67	-256.48	16.67	-260	-162.22	110.93	-94	-70	203.15
-423.67	-253.15	20	-259.67	-162.04	111.11	-90	-67.78	205.37
-420	-251.11	22.04	-256	-160	113.15	-89.67	-67.59	205.56
-419.67	-250.93	22.22	-250	-156.67	116.48	-81.67	-63.15	210
-418.00	-250	23.15	-249.67	-156.48	116.67	-80	-62.22	210.93
-410	-245.56	27.59	-243.67	-153.15	120	-79.67	-62.04	211.11
-409.67	-245.37	27.78	-240	-151.11	122.04	-76	-60	213.15
-405.67	-243.15	30	-239.67	-150.93	122.22	-70	-56.67	216.48
-400	-240	33.15	-238	-150	123.15	-69.67	-56.48	216.67
-399.67	-239.82	33.33	-230	-145.56	127.59	-63.67	-53.15	220
-390	-234.44	38.71	-229.67	-145.37	127.78	-60	-51.11	222.04
-389.67	-234.26	38.89	-225.67	-143.15	130	-59.67	-50.93	222.22
-387.67	-233.15	40	-220	-140	133.15	-58	-50	223.15
-382	-230	43.15	-219.67	-139.82	133.33	-50	-45.56	227.59
-380	-228.89	44.26	-210	-134.44	138.71	-49.67	-45.37	227.78
-379.67	-228.71	44.44	-209.67	-134.26	138.89	-45.67	-43.15	230
-370	-223.33	49.82	-207.67	-133.15	140	-40	-40	233.15
369.67	-223.15	50	-202	-130	143.15	-39.67	-39.82	233.33
-364	-220	53.15	-200	-128.89	144.26	-30	-34.44	238.71
-360	-217.78	55.37	-199.67	-128.71	144.44	-29.67	-34.26	238.89
-359.67	-217.59	55.56	-190	-123.33	149.82	-27.67	-33.15	240
-351.67	-213.15	60	-189.67	-123.15	150	-22	-30	243.15
-350	-212.22	60.93	-184	-120	153.15	-20	-28.89	244.26
-349.67	-212.04	61.11	-180	-117.78	155.37	-19.67	-28.71	244.44
-346	-210	63.15	-179.67	-117.59	155.56	-10	-23.33	249.82
-340	-206.67	66.48	-171.67	-113.15	160	-9.67	-23.15	250
-339.67	-206.48	66.67	-170	-112.22	-160.93	-4	-20	253.15
-333.67	-203.15	70	-169.67	-112.04	161.11	0	-17.78	255.37
-330	-201.11	72.04	-166	-110	163.15	+0.33	-17.59	255.56
-329.67	-200.93	72.22	-160	-106.67	166.48	8.33	-13.15	260
-328	-200	73.15	-159.67	-106.48	166.67	10	-12.22	260.93
-320	-195.56	77.59	-153.67	-103.15	170	10.33	-12.04	261.11
-319.67	-195.37	77.78	-150	-101.11	172.04	14	-10	263.15
-315.67	-193.15	80	-149.67	-100.93	172.22	20	-6.67	266.48
-310	-190	83.15	-148	-100	173.15	20.33	-6.48	266.67
-309.67	-189.82	83.33	-140	-95.96	177.59	26.33	-3.15	270
-300	-184.44	88.71	-139.67	-95.37	177.78	30	-1.11	272.04
-299.67	-184.26	88.89	-135.67	-93.15	180	30.33	-0.93	272.22
-297.67	-183.15	90	-130	-90	183.15	32	0	273.15

TABLE A-1 Temperature conversions

Appendix B: Handling Liquid Helium and Nitrogen

B.1 General

Use of liquid helium (LHe) and liquid nitrogen (LN₂) is often associated with the Model 336 temperature controller. Although not explosive, there are a number of safety considerations to keep in mind in the handling of LHe and LN₂.

B.2 Properties

LHe and LN₂ are colorless, odorless, and tasteless gases. Gaseous nitrogen makes up about 78 percent of the Earth's atmosphere, while helium comprises only about 5 ppm. Most helium is recovered from natural gas deposits. Once collected and isolated, the gases will liquefy when properly cooled. A quick comparison between LHe and LN₂ is provided in Table C-1.

Property	Liquid Helium	Liquid Nitrogen
Boiling Point at 1 atm	4.2 K	77 K
Thermal Conductivity (Gas), w/cm-K	0.083	0.013
Latent Heat of Vaporization, Btu/L	2.4	152
Liquid Density, lb/L	0.275	0.78

TABLE B-1 Comparison of liquid helium and liquid nitrogen

B.3 Handling Cryogenic Storage Dewars

Cryogenic containers (Dewars) must be operated in accordance with the manufacturer instructions. Safety instructions will also be posted on the side of each Dewar. Cryogenic Dewars must be kept in a well-ventilated place where they are protected from the weather and away from any sources of heat. A typical cryogenic Dewar is shown in FIGURE B-1.

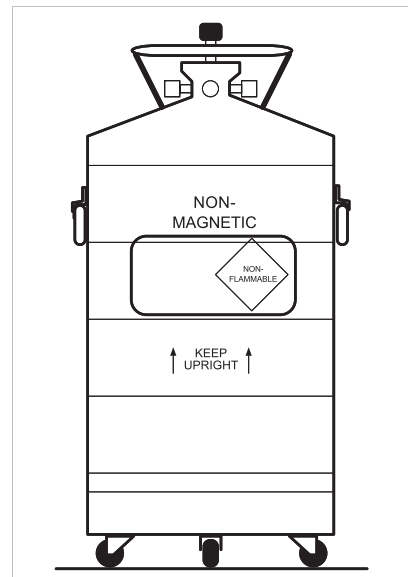

FIGURE B-1 Typical cryogenic storage Dewar

B.4 Liquid Helium and Nitrogen Safety Precautions

Transferring LHe and LN₂ and operation of the storage Dewar controls should be in accordance with the manufacturer/supplier's instructions. During this transfer, it is important that all safety precautions written on the storage Dewar and recommended by the manufacturer be followed.



Liquid helium and liquid nitrogen are potential asphyxiants and can cause rapid suffocation without warning. Store and use in area with adequate ventilation. DO NOT vent container in confined spaces. DO NOT enter confined spaces where gas may be present unless area has been well ventilated. If inhaled, remove to fresh air. If not breathing, give artificial respiration. If breathing is difficult, give oxygen. Get medical help.



Liquid helium and liquid nitrogen can cause severe frostbite to the eyes or skin. DO NOT touch frosted pipes or valves. In case of frostbite, consult a physician at once. If a physician is not readily available, warm the affected areas with water that is near body temperature.

The two most important safety aspects to consider when handling LHe and LN₂ are adequate ventilation and eye and skin protection. Although helium and nitrogen gases are non-toxic, they are dangerous in that they replace the air in a normal breathing atmosphere. Liquid products are of an even greater threat since a small amount of liquid evaporates to create a large amount of gas. Therefore, it is imperative that cryogenic Dewars be stored and the MTD system be operated in open and well ventilated areas.

Persons transferring LHe and LN₂ should make every effort to protect eyes and skin from accidental contact with liquid or the cold gas issuing from it. Protect your eyes with full-face shield or chemical splash goggles. Safety glasses (even with side shields) are not adequate. Always wear special cryogenic gloves (Tempshield Cryo-Gloves® or equivalent) when handling anything that is, or may have been, in contact with the liquid or cold gas, or with cold pipes or equipment. Long sleeve shirts and cuffless trousers that are of sufficient length to prevent liquid from entering the shoes are recommended.

B.5 Recommended First Aid

Every site that stores and uses LHe and LN₂ should have an appropriate Material Safety Data Sheet (MSDS) present. The MSDS may be obtained from the manufacturer/distributor. The MSDS will specify the symptoms of overexposure and the first aid to be used. A typical summary of these instructions is provided as follows.

If symptoms of asphyxia such as headache, drowsiness, dizziness, excitation, excess salivation, vomiting, or unconsciousness are observed, remove the victim to fresh air. If breathing is difficult, give oxygen. If breathing has stopped, give artificial respiration. Call a physician immediately.

If exposure to cryogenic liquids or cold gases occurs, restore tissue to normal body temperature (98.6 °F) as rapidly as possible, then protect the injured tissue from further damage and infection. Call a physician immediately. Rapid warming of the affected parts is best achieved by bathing it in warm water. The water temperature should not exceed 105 °F (40 °C), and under no circumstances should the frozen part be rubbed, either before or after rewarming. If the eyes are involved, flush them thoroughly with warm water for at least 15 minutes. In case of massive exposure, remove clothing while showering with warm water. The patient should not drink alcohol or smoke. Keep warm and rest. Call a physician immediately.

Appendix C: Curve Tables

C.1 General

Standard curve tables included in the Model 336 temperature controller are as follows:

Curve Location	Model	Table
Curve 01	DT-470 Silicon Diode	Table C-2
Curve 02	DT-670 Silicon Diode	Table C-3
Curve 03 & 04	DT-500-D/-E1 Silicon Diode	Table C-4
Curve 06 & 07	PT-100/-1000 Platinum RTD	Table C-5
Curve 08	RX-102A Rox™	Table C-6
Curve 09	RX-202A Rox™	Table C-7
Curve 12	Type K Thermocouple	Table C-8
Curve 13	Type E Thermocouple	Table C-9
Curve 14	Type T Thermocouple	Table C-10
Curve 15	Chromel-AuFe 0.03% Thermocouple	Table C-11
Curve 16	Chromel-AuFe 0.07% Thermocouple	Table C-12

TABLE C-1

Breakpoint	Temp (K)	Volts	Breakpoint	Temp (K)	Volts	Breakpoint	Temp (K)	Volts
1	475.0	0.09062	30	170.0	0.82405	59	031.0	1.10476
2	470.0	0.1191	31	160.0	0.84651	60	030.0	1.10702
3	465.0	0.11356	32	150.0	0.86874	61	029.0	1.10945
4	460.0	0.12547	33	145.0	0.87976	62	028.0	1.11212
5	455.0	0.13759	34	140.0	0.89072	63	027.0	1.11517
6	450.0	0.14985	35	135.0	0.90161	64	026.0	1.11896
7	445.0	0.16221	36	130.0	0.91243	65	025.0	1.12463
8	440.0	0.17464	37	125.0	0.92317	66	024.0	1.13598
9	435.0	0.18710	38	120.0	0.93383	67	023.0	1.15558
10	430.0	0.19961	39	115.0	0.94440	68	022.0	1.17705
11	420.0	0.22463	40	110.0	0.95487	69	021.0	1.19645
12	410.0	0.24964	41	105.0	0.96524	70	019.5	1.22321
13	400.0	0.27456	42	100.0	0.97550	71	017.0	1.26685
14	395.0	0.28701	43	095.0	0.98564	72	015.0	1.30404
15	380.0	0.32417	44	090.0	0.99565	73	013.5	1.33438
16	365.0	0.36111	45	085.0	1.00552	74	012.5	1.35642
17	345.0	0.41005	46	080.0	1.01525	75	011.5	1.38012
18	330.0	0.44647	47	075.0	1.02482	76	010.5	1.40605
19	325.0	0.45860	48	070.0	1.03425	77	009.5	1.43474
20	305.0	0.50691	49	065.0	1.04353	78	008.5	1.46684
21	300.0	0.51892	50	058.0	1.05630	79	007.5	1.50258
22	285.0	0.55494	51	052.0	1.06702	80	005.2	1.59075
23	265.0	0.60275	52	046.0	1.07750	81	004.2	1.62622
24	250.0	0.63842	53	040.0	1.08781	82	003.4	1.65156
25	235.0	0.67389	54	039.0	1.08953	83	002.6	1.67398
26	220.0	0.70909	55	036.0	1.09489	84	002.1	1.68585
27	205.0	0.74400	56	034.0	1.09864	85	001.7	1.69367
28	190.0	0.77857	57	033.0	1.10060	86	001.4	1.69818
29	180.0	0.80139	58	032.0	1.10263			

TABLE C-2 Lake Shore DT-470 Silicon Diode (Curve 01)

Breakpoint	Volts	Temp (K)	Breakpoint	Volts	Temp (K)	Breakpoint	Volts	Temp (K)
1	0.090570	500.00	26	1.01064	87.0	51	1.19475	20.2
2	0.110239	491.0	27	1.02125	81.0	52	1.24208	17.10
3	0.136555	479.5	28	1.03167	75.0	53	1.26122	15.90
4	0.179181	461.5	29	1.04189	69.0	54	1.27811	14.90
5	0.265393	425.5	30	1.05192	63.0	55	1.29430	14.00
6	0.349522	390.0	31	1.06277	56.4	56	1.31070	13.15
7	0.452797	346.0	32	1.07472	49.0	57	1.32727	12.35
8	0.513393	320.0	33	1.09110	38.7	58	1.34506	11.55
9	0.563128	298.5	34	1.09602	35.7	59	1.36423	10.75
10	0.607845	279.0	35	1.10014	33.3	60	1.38361	10.0
11	0.648723	261.0	36	1.10393	31.2	61	1.40454	9.25
12	0.686936	244.0	37	1.10702	29.6	62	1.42732	8.50
13	0.722511	228.0	38	1.10974	28.3	63	1.45206	7.75
14	0.755487	213.0	39	1.11204	27.3	64	1.48578	6.80
15	0.786992	198.5	40	1.11414	26.5	65	1.53523	5.46
16	0.817025	184.5	41	1.11628	25.8	66	1.56684	4.56
17	0.844538	171.5	42	1.11853	25.2	67	1.58358	4.04
18	0.869583	159.5	43	1.12090	24.7	68	1.59690	3.58
19	0.893230	148.0	44	1.12340	24.3	69	1.60756	3.18
20	0.914469	137.5	45	1.12589	24.0	70	1.62125	2.62
21	0.934356	127.5	46	1.12913	23.7	71	1.62945	2.26
22	0.952903	118.0	47	1.13494	23.3	72	1.63516	1.98
23	0.970134	109.0	48	1.14495	22.8	73	1.63943	1.74
24	0.986073	100.5	49	1.16297	22.0	74	1.64261	1.53
25	0.998925	93.5	50	1.17651	21.3	75	1.64430	1.40

TABLE C-3 Standard DT-670 diode curve

Breakpoint	DT-500-D Curve		DT-500-E1 Curve	
	Temp (K)	Volts	Temp (K)	Volts
1	365.0	0.19083	330.0	0.28930
2	345.0	0.24739	305.0	0.36220
3	305.0	0.36397	285.0	0.41860
4	285.0	0.42019	265.0	0.47220
5	265.0	0.47403	240.0	0.53770
6	240.0	0.53960	220.0	0.59260
7	220.0	0.59455	170.0	0.73440
8	170.0	0.73582	130.0	0.84490
9	130.0	0.84606	100.0	0.92570
10	090.0	0.95327	075.0	0.99110
11	070.0	1.00460	060.0	1.02840
12	055.0	1.04070	040.0	1.07460
13	040.0	1.07460	036.0	1.08480
14	034.0	1.09020	034.0	1.09090
15	032.0	1.09700	032.0	1.09810
16	030.0	1.10580	030.0	1.10800
17	029.0	1.11160	029.0	1.11500
18	028.0	1.11900	028.0	1.12390
19	027.0	1.13080	027.0	1.13650
20	026.0	1.14860	026.0	1.15590
21	025.0	1.17200	025.0	1.18770
22	023.0	1.25070	024.0	1.23570

TABLE C-4 Lake Shore DT-500 series silicon diode curves (no longer in production)

Breakpoint	DT-500-D Curve		DT-500-E1 Curve	
	Temp (K)	Volts	Temp (K)	Volts
23	021.0	1.35050	022.0	1.32570
24	017.0	1.63590	018.0	1.65270
25	015.0	1.76100	013.0	1.96320
26	013.0	1.90660	009.0	2.17840
27	009.0	2.11720	004.0	2.53640
28	003.0	2.53660	003.0	2.59940
29	001.4	2.59840	001.4	2.65910

TABLE C-4 Lake Shore DT-500 series silicon diode curves (no longer in production)

Breakpoint	PT-100		PT-1000	
	Temp (K)	Ohms (Ω)	Temp (K)	Ohms (Ω)
1	030.0	3.820	030.0	38.20
2	032.0	4.235	032.0	42.35
3	036.0	5.146	036.0	51.46
4	038.0	5.650	038.0	56.50
5	040.0	6.170	040.0	61.70
6	042.0	6.726	042.0	67.26
7	046.0	7.909	046.0	79.09
8	052.0	9.924	052.0	99.24
9	058.0	12.180	058.0	121.80
10	065.0	15.015	065.0	150.15
11	075.0	19.223	075.0	192.23
12	085.0	23.525	085.0	235.25
13	105.0	32.081	105.0	320.81
14	140.0	46.648	140.0	466.48
15	180.0	62.980	180.0	629.80
16	210.0	75.044	210.0	750.44
17	270.0	98.784	270.0	987.84
18	315.0	116.270	315.0	1162.70
19	355.0	131.616	355.0	1316.16
20	400.0	148.652	400.0	1486.52
21	445.0	165.466	445.0	1654.66
22	490.0	182.035	490.0	1820.35
23	535.0	198.386	535.0	1983.86
24	585.0	216.256	585.0	2162.56
25	630.0	232.106	630.0	2321.06
26	675.0	247.712	675.0	2477.12
27	715.0	261.391	715.0	2613.91
28	760.0	276.566	760.0	2765.66
29	800.0	289.830	800.0	2898.30

TABLE C-5 Lake Shore PT-100/-1000 platinum RTD curves

Breakpoint	log Ω	Temp (K)	Breakpoint	log Ω	Temp (K)	Breakpoint	log Ω	Temp (K)
1	3.02081	40.0	36	3.05186	13.50	71	3.17838	2.96
2	3.02133	38.8	37	3.05322	13.10	72	3.18540	2.81
3	3.02184	37.7	38	3.05466	12.70	73	3.19253	2.67
4	3.02237	36.6	39	3.05618	12.30	74	3.20027	2.53
5	3.02294	35.5	40	3.05780	11.90	75	3.20875	2.39
6	3.02353	34.4	41	3.05952	11.50	76	3.21736	2.26
7	3.02411	33.4	42	3.06135	11.10	77	3.22675	2.13
8	3.02472	32.4	43	3.06330	10.70	78	3.23707	2.00
9	3.02537	31.4	44	3.06537	10.30	79	3.24842	1.87
10	3.02605	30.4	45	3.06760	9.90	80	3.26000	1.75
11	3.02679	29.4	46	3.06968	9.55	81	3.27169	1.64
12	3.02749	28.5	47	3.07190	9.20	82	3.28462	1.53
13	3.02823	27.6	48	3.07428	8.85	83	3.29779	1.43
14	3.02903	26.7	49	3.07685	8.50	84	3.31256	1.33
15	3.02988	25.8	50	3.07922	8.20	85	3.32938	1.23
16	3.03078	24.9	51	3.08175	7.90	86	3.34846	1.130
17	3.03176	24.0	52	3.08447	7.60	87	3.37196	1.020
18	3.03280	23.1	53	3.08786	7.25	88	3.39220	0.935
19	3.03393	22.2	54	3.09150	6.90	89	3.41621	0.850
20	3.03500	21.4	55	3.09485	6.60	90	3.44351	0.765
21	3.03615	20.6	56	3.09791	6.35	91	3.47148	0.690
22	3.03716	19.95	57	3.10191	6.05	92	3.50420	0.615
23	3.03797	19.45	58	3.10638	5.74	93	3.54057	0.545
24	3.03882	18.95	59	3.11078	5.46	94	3.58493	0.474
25	3.03971	18.45	60	3.11558	5.18	95	3.63222	0.412
26	3.04065	17.95	61	3.12085	4.90	96	3.68615	0.354
27	3.04164	17.45	62	3.12622	4.64	97	3.75456	0.295
28	3.04258	17.00	63	3.13211	4.38	98	3.82865	0.245
29	3.04357	16.55	64	3.13861	4.12	99	3.91348	0.201
30	3.04460	16.10	65	3.14411	3.92	100	4.01514	0.162
31	3.04569	15.65	66	3.14913	3.75	101	4.14432	0.127
32	3.04685	15.20	67	3.15454	3.58	102	4.34126	0.091
33	3.04807	14.75	68	3.16002	3.42	103	4.54568	0.066
34	3.04936	14.30	69	3.16593	3.26	104	4.79803	0.050
35	3.05058	13.90	70	3.17191	3.11			

TABLE C-6 Lake Shore RX-102A Rox™ curve

Breakpoint	log Ω	Temp (K)	Breakpoint	log Ω	Temp (K)	Breakpoint	log Ω	Temp (K)
1	3.35085	40.0	34	3.40482	11.45	67	3.52772	2.17
2	3.35222	38.5	35	3.40688	11.00	68	3.53459	2.04
3	3.35346	37.2	36	3.40905	10.55	69	3.54157	1.92
4	3.35476	35.9	37	3.41134	10.10	70	3.54923	1.80
5	3.35612	34.6	38	3.41377	9.65	71	3.55775	1.68
6	3.35755	33.3	39	3.41606	9.25	72	3.56646	1.57
7	3.35894	32.1	40	3.41848	8.85	73	3.57616	1.46
8	3.36039	30.9	41	3.42105	8.45	74	3.58708	1.35
9	3.36192	29.7	42	3.42380	8.05	75	3.59830	1.25
10	3.36340	28.6	43	3.42637	7.70	76	3.61092	1.150
11	3.36495	27.5	44	3.42910	7.35	77	3.62451	1.055
12	3.36659	26.4	45	3.43202	7.00	78	3.63912	0.965
13	3.36831	25.3	46	3.43515	6.65	79	3.65489	0.880
14	3.37014	24.2	47	3.43853	6.30	80	3.67206	0.800
15	3.37191	23.2	48	3.44230	5.94	81	3.69095	0.725
16	3.37377	22.2	49	3.44593	5.62	82	3.71460	0.645
17	3.37575	21.2	50	3.44984	5.30	83	3.73889	0.575
18	3.37785	20.2	51	3.45355	5.02	84	3.76599	0.510
19	3.37942	19.50	52	3.45734	4.76	85	3.79703	0.448
20	3.38081	18.90	53	3.46180	4.48	86	3.83269	0.390
21	3.38226	18.30	54	3.46632	4.22	87	3.87369	0.336
22	3.38377	17.70	55	3.47012	4.02	88	3.92642	0.281
23	3.38522	17.15	56	3.47357	3.85	89	3.98609	0.233
24	3.38672	16.60	57	3.47726	3.68	90	4.05672	0.190
25	3.38829	16.05	58	3.48122	3.51	91	4.14042	0.153
26	3.38993	15.50	59	3.48524	3.35	92	4.24807	0.120
27	3.39165	14.95	60	3.48955	3.19	93	4.40832	0.088
28	3.39345	14.40	61	3.49421	3.03	94	4.57858	0.067
29	3.39516	13.90	62	3.49894	2.88	95	4.76196	0.055
30	3.39695	13.40	63	3.50406	2.73	96	4.79575	0.051
31	3.39882	12.90	64	3.50962	2.58	97	4.81870	0.050
32	3.40079	12.40	65	3.51528	2.44			
33	3.40286	11.90	66	3.52145	2.30			

TABLE C-7 Lake Shore RX-202A Rox™ curve

Break-point	mV	Temp (K)	Break-point	mV	Temp (K)	Break-point	mV	Temp (K)	Break-point	mV	Temp (K)
1	-6.45774	3.15	48	-6.10828	57.4	95	-2.95792	192	142	18.1482	714.5
2	-6.45733	3.68	49	-6.08343	59.4	96	-2.82629	196	143	19.2959	741.5
3	-6.45688	4.2	50	-6.05645	61.5	97	-2.6762	200.5	144	20.8082	777
4	-6.45632	4.78	51	-6.02997	63.5	98	-2.52392	205	145	23.1752	832.5
5	-6.45565	5.4	52	-6.00271	65.5	99	-2.36961	209.5	146	24.5166	864
6	-6.45494	6	53	-5.97469	67.5	100	-2.21329	214	147	25.6001	889.5
7	-6.4541	6.65	54	-5.94591	69.5	101	-2.05503	218.5	148	26.5536	912
8	-6.4531	7.35	55	-5.91637	71.5	102	-1.87703	223.5	149	27.4199	932.5
9	-6.45201	8.05	56	-5.8861	73.5	103	-1.69672	228.5	150	28.2413	952
10	-6.45073	8.8	57	-5.85508	75.5	104	-1.51427	233.5	151	29.0181	970.5
11	-6.44934	9.55	58	-5.82334	77.5	105	-1.32972	238.5	152	29.7714	988.5
12	-6.44774	10.35	59	-5.78268	80	106	-1.12444	244	153	30.5011	1006
13	-6.44601	11.15	60	-5.74084	82.5	107	-0.91675	249.5	154	31.2074	1023
14	-6.44403	12	61	-5.69792	85	108	-0.70686	255	155	31.8905	1039.5
15	-6.44189	12.85	62	-5.6539	87.5	109	-0.47553	261	156	32.571	1056
16	-6.43947	13.75	63	-5.60879	90	110	-0.22228	267.5	157	33.2489	1072.5
17	-6.43672	14.7	64	-5.5626	92.5	111	0.053112	274.5	158	33.9038	1088.5
18	-6.43378	15.65	65	-5.51535	95	112	0.350783	282	159	34.5561	1104.5
19	-6.43065	16.6	66	-5.46705	97.5	113	0.651006	289.5	160	35.2059	1120.5
20	-6.42714	17.6	67	-5.4177	100	114	0.973714	297.5	161	35.8532	1136.5
21	-6.42321	18.65	68	-5.36731	102.5	115	1.31919	306	162	36.4979	1152.5
22	-6.41905	19.7	69	-5.3159	105	116	1.70801	315.5	163	37.14	1168.5
23	-6.41442	20.8	70	-5.26348	107.5	117	2.14052	326	164	37.7596	1184
24	-6.40952	21.9	71	-5.19928	110.5	118	2.69954	339.5	165	38.3767	1199.5
25	-6.40435	23	72	-5.13359	113.5	119	3.75883	365	166	38.9915	1215
26	-6.39841	24.2	73	-5.06651	116.5	120	4.29687	378	167	39.6038	1230.5
27	-6.39214	25.4	74	-4.99801	119.5	121	4.74986	389	168	40.2136	1246
28	-6.38554	26.6	75	-4.92813	122.5	122	5.17977	399.5	169	40.821	1261.5
29	-6.37863	27.8	76	-4.85687	125.5	123	5.60705	410	170	41.4063	1276.5
30	-6.37077	29.1	77	-4.78426	128.5	124	6.03172	420.5	171	41.9893	1291.5
31	-6.36253	30.4	78	-4.71031	131.5	125	6.49428	432	172	42.5699	1306.5
32	-6.35391	31.7	79	-4.63503	134.5	126	7.09465	447	173	43.1288	1321
33	-6.34422	33.1	80	-4.55845	137.5	127	8.15226	473.5	174	43.6853	1335.5
34	-6.33408	34.5	81	-4.48056	140.5	128	8.75291	488.5	175	44.2394	1350
35	-6.3235	35.9	82	-4.38814	144	129	9.25576	501	176	44.7721	1364
36	-6.3117	37.4	83	-4.29393	147.5	130	9.74087	513	177	45.3024	1378
37	-6.29939	38.9	84	-4.19806	151	131	10.2285	525	178	45.8114	1391.5
38	-6.2866	40.4	85	-4.10051	154.5	132	10.7186	537	179	46.3182	1405
39	-6.27241	42	86	-4.00133	158	133	11.2317	549.5	180	46.8038	1418
40	-6.25768	43.6	87	-3.90053	161.5	134	11.7883	563	181	47.2873	1431
41	-6.24239	45.2	88	-3.79815	165	135	12.3888	577.5	182	47.7684	1444
42	-6.22656	46.8	89	-3.6942	168.5	136	13.054	593.5	183	48.2287	1456.5
43	-6.21019	48.4	90	-3.58873	172	137	13.7844	611	184	48.6868	1469
44	-6.19115	50.2	91	-3.46638	176	138	14.5592	629.5	185	49.1426	1481.5
45	-6.17142	52	92	-3.34204	180	139	15.3786	649	186	49.5779	1493.5
46	-6.15103	53.8	93	-3.21584	184	140	16.2428	669.5	187	50.0111	1505.5
47	-6.12998	55.6	94	-3.08778	188	141	17.1518	691			

TABLE C-8 Type K (Nickel-Chromium vs. Nickel-Aluminum) thermocouple curve

Breakpoint	mV	Temp (K)	Breakpoint	mV	Temp (K)	Breakpoint	mV	Temp (K)
1	-9.834960	3.15	55	-8.713010	77.50	109	0.701295	285.0
2	-9.834220	3.59	56	-8.646710	80.00	110	1.061410	291.00
3	-9.833370	4.04	57	-8.578890	82.50	111	1.424820	297.00
4	-9.832260	4.56	58	-8.509590	85.00	112	1.791560	303.00
5	-9.830920	5.12	59	-8.438800	87.50	113	2.161610	309.00
6	-9.829330	5.72	60	-8.366570	90.00	114	2.534960	315.00
7	-9.827470	6.35	61	-8.292900	92.50	115	2.943070	321.50
8	-9.825370	7.00	62	-8.217810	95.00	116	3.355100	328.00
9	-9.822890	7.70	63	-8.141330	97.50	117	3.770870	334.50
10	-9.820010	8.45	64	-8.047780	100.50	118	4.190420	341.00
11	-9.816880	9.20	65	-7.952190	103.50	119	4.613650	347.50
12	-9.813290	10.00	66	-7.854690	106.50	120	5.040520	354.00
13	-9.809180	10.85	67	-7.755260	109.50	121	5.470960	360.50
14	-9.804510	11.75	68	-7.653960	112.50	122	5.938380	367.50
15	-9.799510	12.65	69	-7.550790	115.50	123	6.409870	374.50
16	-9.793900	13.60	70	-7.445790	118.50	124	6.885210	381.50
17	-9.787610	14.60	71	-7.338970	121.50	125	7.364360	388.50
18	-9.780590	15.65	72	-7.230370	124.50	126	7.881760	396.00
19	-9.773150	16.70	73	-7.120010	127.50	127	8.403380	403.50
20	-9.764910	17.80	74	-6.989110	131.00	128	8.928940	411.00
21	-9.755820	18.95	75	-6.855790	134.50	129	9.493760	419.00
22	-9.746230	20.10	76	-6.720200	138.00	130	10.0629	427.00
23	-9.735700	21.30	77	-6.582330	141.50	131	10.6361	435.00
24	-9.724650	22.50	78	-6.442220	145.00	132	11.2494	443.50
25	-9.713080	23.70	79	-6.299900	148.50	133	11.867	452.00
26	-9.699960	25.00	80	-6.155400	152.00	134	12.5253	461.00
27	-9.686220	26.30	81	-6.008740	155.50	135	13.188	470.00
28	-9.671890	27.60	82	-5.859960	159.00	136	13.892	479.50
29	-9.655790	29.00	83	-5.687430	163.00	137	14.6005	489.00
30	-9.638980	30.40	84	-5.512090	167.00	138	15.3507	499.00
31	-9.621500	31.80	85	-5.334130	171.00	139	16.1432	509.50
32	-9.602020	33.30	86	-5.153520	175.00	140	16.9403	520.00
33	-9.581740	34.80	87	-4.970330	179.00	141	17.7798	531.00
34	-9.560710	36.30	88	-4.784590	183.00	142	18.6624	542.50
35	-9.537440	37.90	89	-4.596330	187.00	143	19.5881	554.50
36	-9.513290	39.50	90	-4.405600	191.00	144	20.5573	567.00
37	-9.486720	41.20	91	-4.212440	195.00	145	21.5702	580.00
38	-9.457560	43.00	92	-3.992330	199.50	146	22.627	593.50
39	-9.427340	44.80	93	-3.769140	204.00	147	23.7279	607.50
40	-9.396080	46.60	94	-3.543070	208.50	148	24.873	622.00
41	-9.363810	48.40	95	-3.314120	213.00	149	26.0623	637.00
42	-9.330540	50.20	96	-3.082340	217.50	150	27.3356	653.00
43	-9.296270	52.00	97	-2.847790	222.00	151	28.6935	670.00
44	-9.257090	54.00	98	-2.610520	226.50	152	30.1761	688.50
45	-9.216690	56.00	99	-2.343820	231.50	153	31.8242	709.00
46	-9.175140	58.00	100	-2.073770	236.50	154	33.7187	732.50
47	-9.132450	60.00	101	-1.800570	241.50	155	36.1028	762.00
48	-9.088620	62.00	102	-1.524210	246.50	156	41.8502	833.00
49	-9.043710	64.00	103	-1.244740	251.50	157	44.2747	863.00
50	-8.997710	66.00	104	-0.962207	256.50	158	46.2907	888.00
51	-8.950650	68.00	105	-0.676647	261.50	159	48.1007	910.50
52	-8.902530	70.00	106	-0.359204	267.00	160	49.8256	932.00
53	-8.840980	72.50	107	-0.009079	273.00	161	51.5056	953.00
54	-8.777760	75.00	108	0.344505	279.00			

TABLE C-9 Type E (Nickel-Chromium vs. Copper-Nickel) Thermocouple Curve

Breakpoint	mV	Temp (K)	Breakpoint	mV	Temp (K)	Breakpoint	mV	Temp (K)
1	-6.257510	3.15	56	-5.424100	84.00	111	0.623032	289.00
2	-6.257060	3.56	57	-5.380600	86.50	112	0.843856	294.50
3	-6.256520	4.00	58	-5.336260	89.00	113	1.067190	300.00
4	-6.255810	4.50	59	-5.291080	91.50	114	1.293090	305.50
5	-6.254950	5.04	60	-5.245070	94.00	115	1.521570	311.00
6	-6.253920	5.62	61	-5.188800	97.00	116	1.752660	316.50
7	-6.252780	6.20	62	-5.131290	100.00	117	1.986340	322.00
8	-6.251380	6.85	63	-5.072630	103.00	118	2.222600	327.50
9	-6.249730	7.55	64	-5.012780	106.00	119	2.461410	333.00
10	-6.247810	8.30	65	-4.951770	109.00	120	2.702740	338.50
11	-6.245590	9.10	66	-4.889610	112.00	121	2.946550	344.00
12	-6.243040	9.95	67	-4.826300	115.00	122	3.192800	349.50
13	-6.240300	10.80	68	-4.761840	118.00	123	3.441440	355.00
14	-6.237210	11.70	69	-4.696250	121.00	124	3.715300	361.00
15	-6.233710	12.65	70	-4.629530	124.00	125	3.991980	367.00
16	-6.229800	13.65	71	-4.561670	127.00	126	4.271300	373.00
17	-6.225630	14.65	72	-4.492700	130.00	127	4.553250	379.00
18	-6.221000	15.70	73	-4.422610	133.00	128	4.837770	385.00
19	-6.215860	16.80	74	-4.351390	136.00	129	5.148790	391.50
20	-6.210430	17.90	75	-4.266950	139.50	130	5.462770	398.00
21	-6.204430	19.05	76	-4.180930	143.00	131	5.779560	404.50
22	-6.198680	20.10	77	-4.093440	146.50	132	6.099160	411.00
23	-6.191780	21.30	78	-4.004430	150.00	133	6.421500	417.50
24	-6.184530	22.50	79	-3.913940	153.50	134	6.746540	424.00
25	-6.176930	23.70	80	-3.821970	157.00	135	7.099510	431.00
26	-6.168310	25.00	81	-3.728520	160.50	136	7.455590	438.00
27	-6.159280	26.30	82	-3.633620	164.00	137	7.814630	445.00
28	-6.149830	27.60	83	-3.537260	167.50	138	8.176630	452.00
29	-6.139220	29.00	84	-3.439460	171.00	139	8.541540	459.00
30	-6.128130	30.40	85	-3.340240	174.50	140	8.909320	466.00
31	-6.116580	31.80	86	-3.239610	178.00	141	9.306450	473.50
32	-6.103700	33.30	87	-3.122930	182.00	142	9.706830	481.00
33	-6.090300	34.80	88	-3.004370	186.00	143	10.1103	488.50
34	-6.075460	36.40	89	-2.884040	190.00	144	10.5169	496.00
35	-6.060040	38.00	90	-2.761910	194.00	145	10.9264	503.50
36	-6.044070	39.60	91	-2.638010	198.00	146	11.3664	511.50
37	-6.025470	41.40	92	-2.512340	202.00	147	11.8098	519.50
38	-6.006200	43.20	93	-2.384920	206.00	148	12.2564	527.50
39	-5.986280	45.00	94	-2.255770	210.00	149	12.7342	536.00
40	-5.965730	46.80	95	-2.124900	214.00	150	13.2155	544.50
41	-5.942210	48.80	96	-1.992320	218.00	151	13.7	553.00
42	-5.917930	50.80	97	-1.858060	222.00	152	14.1879	561.50
43	-5.892970	52.80	98	-1.705090	226.50	153	14.7079	570.50
44	-5.864730	55.00	99	-1.549970	231.00	154	15.2314	579.50
45	-5.835680	57.20	100	-1.392820	235.50	155	15.7583	588.50
46	-5.805860	59.40	101	-1.233640	240.00	156	16.2887	597.50
47	-5.776670	61.50	102	-1.072450	244.50	157	16.8224	606.50
48	-5.741100	64.00	103	-0.909257	249.00	158	17.3594	615.50
49	-5.704560	66.50	104	-0.744065	253.50	159	17.9297	625.00
50	-5.667130	69.00	105	-0.576893	258.00	160	18.5037	634.50
51	-5.628800	71.50	106	-0.407776	262.50	161	19.1116	644.50
52	-5.589590	74.00	107	-0.217705	267.50	162	19.7538	655.00
53	-5.549510	76.50	108	-0.025325	272.50	163	20.4611	666.50
54	-5.508560	79.00	109	0.188573	278.00	164	20.8627	673.00
55	-5.466760	81.50	110	0.404639	283.50			

TABLE C-10 Type T (Copper vs. Copper-Nickel) thermocouple curve

Breakpoint	mV	Temp (K)	Breakpoint	mV	Temp (K)
1	-4.6667		32	-2.24537	160
2	-4.62838	6.35	33	-2.06041	170
3	-4.60347	8.15	34	-1.86182	180.5
4	-4.58043	9.75	35	-1.66004	191
5	-4.53965	12.5	36	-1.47556	200.5
6	-4.47226	16.95	37	-1.0904	220
7	-4.43743	19.3	38	-0.73397	237.5
8	-4.39529	22.2	39	-0.68333	240
9	-4.34147	26	40	-0.3517	256
10	-4.29859	29.1	41	-0.2385	261.5
11	-4.26887	31.3	42	0.078749	277
12	-4.22608	34.5	43	0.139668	280
13	-4.2018	36.3	44	0.426646	294.5
14	-4.02151	49.8	45	0.546628	300.5
15	-3.94549	55.4	46	0.858608	316
16	-3.87498	60.5	47	0.938667	320
17	-3.80464	65.5	48	1.3456	340
18	-3.73301	70.5	49	1.7279	358.5
19	-3.65274	76	50	1.76905	360.5
20	-3.5937	80	51	2.20705	381.5
21	-3.51113	85.5	52	2.51124	396
22	-3.45023	89.5	53	2.69878	405
23	-3.43451	90.5	54	2.94808	417
24	-3.37842	94	55	3.13562	426
25	-3.35469	95.5	56	3.43707	440.5
26	-3.28237	100	57	3.85513	460.5
27	-3.11919	110	58	4.17136	475.5
28	-2.95269	120	59	4.28662	481
29	-2.78168	130	60	4.64037	498
30	-2.60639	140	61	4.68168	500
31	-2.42737	150			

TABLE C-11 Chromel-AuFe 0.03% thermocouple curve

Breakpoint	mV	Temp (K)	Breakpoint	mV	Temp (K)	Breakpoint	mV	Temp (K)
1	-5.279520	3.15	35	-3.340820	115.00	69	1.313400	
2	-5.272030	3.78	36	-3.253410	119.50	70	1.511140	341.50
3	-5.263500	4.46	37	-3.165360	124.00	71	1.709250	350.50
4	-5.253730	5.20	38	-3.076690	128.50	72	1.928940	360.50
5	-5.242690	6.00	39	-2.977480	133.50	73	2.127070	369.50
6	-5.229730	6.90	40	-2.877550	138.50	74	2.324710	378.50
7	-5.214770	7.90	41	-2.776950	143.50	75	2.523070	387.50
8	-5.196980	9.05	42	-2.675700	148.50	76	2.643480	393.00
9	-5.176250	10.35	43	-2.563610	154.00	77	2.708890	396.00
10	-5.150910	11.90	44	-2.450770	159.50	78	2.764030	398.50
11	-5.116700	13.95	45	-2.337230	165.00	79	2.797580	400.00
12	-5.049770	17.90	46	-2.223010	170.50	80	2.950200	406.50
13	-5.002120	20.70	47	-2.097700	176.50	81	3.008310	409.00
14	-4.938000	24.50	48	-1.971630	182.50	82	3.031200	410.00
15	-4.876180	28.20	49	-1.844890	188.50	83	3.218040	418.00
16	-4.801670	32.70	50	-1.706840	195.00	84	3.300110	421.50
17	-4.648620	42.00	51	-1.568040	201.50	85	4.000810	451.50
18	-4.569170	46.80	52	-1.428520	208.00	86	4.246390	462.00
19	-4.499080	51.00	53	-1.277520	215.00	87	4.701810	481.50
20	-4.435090	54.80	54	-1.114900	222.50	88	4.947390	492.00
21	-4.370520	58.60	55	-0.940599	230.50	89	5.636410	521.50
22	-4.303610	62.50	56	-0.754604	239.00	90	5.870300	531.50
23	-4.234290	66.50	57	-0.556906	248.00	91	6.547630	560.50
24	-4.164270	70.50	58	-0.358437	257.00	92	6.711600	567.50
25	-4.093560	74.50	59	-0.170179	265.50	93	6.781410	570.50
26	-4.022170	78.50	60	0.041150	275.00	94	6.931500	577.00
27	-3.950100	82.50	61	0.152699	280.00	95	7.001360	580.00
28	-3.877360	86.50	62	0.163149	280.50	96	7.166710	587.00
29	-3.803960	90.50	63	0.374937	290.00	97	7.260420	591.00
30	-3.729910	94.50	64	0.542973	297.50	98	7.412010	597.50
31	-3.655230	98.50	65	0.598604	300.00	99	7.529070	602.50
32	-3.579930	102.50	66	0.774384	308.00	100	7.657460	608.00
33	-3.504020	106.50	67	0.840638	311.00	101	7.704410	610.00
34	-3.427530	110.50	68	1.126350	324.00			

TABLE C-12 Chromel-AuFe 0.07% thermocouple curve